

CABLES FOR A MOVING WORLD

TRATOS GENERAL CABLES®



CABLES FOR A MOVING WORLD

TRATOS[®] ENERGY DNOs

Tratos Utility cables are designed and tested to meet relevant UK, European and International standards. Manufactured in state of the art manufacturing facilities, the company's purpose-built, in-house Fire, Chemical, Electrical and Physical testing facilities and laboratories deliver peace of mind to customers ensuring their choice of Utility cable products meet all statutory and regulatory requirements.



www.tratosgroup.com



INDEX

Standars and Quality System	p. 10
Technical information	p. 11
TRATOS H05V-K — TRATOS H07V-K Cable suitable for protected installation in lighting and control appliances	p. 12
TRATOS H07V-U Cable suitable for protected installation in lighting and control appliances	p. 14
TRATOS H07V-R Cable suitable for protected installation in lighting and control appliances	p. 16
TRATOS H05V2-K — TRATOS H07V2-K Cable suitable for the supply of electricity in buildings and other civil engineering works	p. 18
TRATOS H05V2-U Suitable for installations inside lighting devices	p. 20
TRATOS H07V2-U Suitable for installations in above ground or built-in pipes or similar closed systems	p. 21
TRATOS H07V2-R Suitable for installations in above ground or built-in pipes or similar closed systems	p. 22
TRATOS H05Z-K — TRATOS H07Z-K Cable suitable for protected installation in lighting and control appliances	p. 24
TRATOS H05Z-U — TRATOS H07Z-U Cable suitable for protected installation in lighting and control appliances	p. 26
TRATOS H07Z-R Cable suitable for protected installation in lighting and control appliances	p. 28
TRATOS H07Z1-K type 2 (Dca) Suitable for fixed protected installations in lighting and control gear	p. 30
TRATOS H07Z1-K type 2 (Cca) Suitable for fixed protected installations in lighting and control gear	p. 32
TRATOS H07Z1-U type 2 (Dca) Suitable for fixed protected installations in lighting and control gear	p. 34
TRATOS H05Z1-K (Cca) For installation in surface-mounted or embedded conduits or similar closed systems	p. 36
TRATOS H07Z1-U type 2 (Cca) Suitable for fixed protected installations in lighting and control gear	p. 38
TRATOS H07Z1-R type 2 (Dca) Suitable for fixed protected installations in lighting and control gear	p. 40
TRATOS H07Z1-R type 2 (Cca) Suitable for fixed protected installations in lighting and control gear	p. 42

TRATOS H03VV-F — TRATOS H05VV-F Cable suitable for mobile use	p. 44
TRATOS H03VVH2-F Cable suitable for mobile use	p. 46
TRATOS H05VVH2-F Cable suitable for mobile use	p. 47
TRATOS H03V2V2-F — TRATOS H05V2V2-F Cable suitable for mobile use	p. 48
TRATOS H03V2V2H2-F Cable suitable for mobile use	p. 50
TRATOS H05V2V2H2-F Cable suitable for mobile use	p. 51
TRATOS H05VV5-F For applications requiring resistance to general purpose mineral oils	p. 52
TRATOS H05VVC4V5-K For applications requiring resistance to general purpose mineral oils	p. 54
TRATOS H05RR-F Cable suitable for mobile use	p. 56
TRATOS H05RN-F Cable suitable for mobile use	p. 58
TRATOS H07RN-F Cable suitable for both mobile and fixed laying	p. 60
TRATOS H07RN8-F Cable suitable for connections subject to moderate mechanical loads	p. 64
TRATOS H07RN-F Plus Cable suitable for connections of constructive elements of lifting appliances and machines	p. 68
TRATOS H07BN4-F Cable suitable for both mobile and fixed laying	p. 72
TRATOS H07ZZ-F (Cca) Cable suitable for both mobile and fixed laying	p. 76
TRATOS H07ZZ-F (Dca) Cable suitable for locations where a low level of emission of smoke and corrosive gases are required	p. 80
TRATOS H07BQ-F Cable suitable for heavy-duty uses and to power industrial and farm machinery	p. 84
TRATOS 07BQ-F Cable suitable for heavy-duty uses and to power industrial and farm machinery	p. 88
TRATOS S1BQ-F Cable suitable for heavy-duty uses and to power industrial and farm machinery	p. 92
TRATOS H01N2-D Cable suitable for use on arc-welders	p. 94

TRATOS FS17 Cable suitable for static, protected use	p. 96
TRATOS FG17 Cable suitable for static, protected use	p. 98
TRATOS FS18OR18 - 300/500 V Cable suitable in small spaces	p. 100
TRATOS FS18OR18 - 450/750 V Cable suitable in small spaces	p. 104
TRATOS FLEX-OIL PLUS 450/750 V Cable suitable for use in dry, humid or wet environments subject to moderate mechanical loads	p. 106
TRATOS FLEX-OIL PLUS SCH. 450/750 V Cable suitable for use in dry, humid or wet environments subject to moderate mechanical loads	p. 110
TRATOS FG16(O)R16 Cable suitable for energy supply in industry, building sites and construction industry	p. 112
TRATOS FG16OH2R16 Cable suitable for energy supply in industry, building sites and construction industry	p. 118
TRATOS FG16(O)M16 Cable suitable for energy supply in public places of fire hazard	p. 122
TRATOS FG18M16 — TRATOS FG18OM16 Cable suitable for bundle installations in environments at higher risk in case of fire	p. 126
TRATOS FTG18(O)M16-0,6/1 kV Cable suitable for the transport of power and transmission of signals and controls in electrical installations	p. 130
TRATOS ARG16R16-0,6/1 kV Cable suitable for the transport of power in the industry, construction sites and housing	p. 134
TRATOS UG7OCR — TRATOS RG7OCR Cable suitable for the transport of power in free air	p. 136
TRATOS NPE® SUN H1Z2Z2-K Cable suitable for use in photovoltaic installations	p. 138
TRATOS NPE® SUN PLUS H1Z2Z2-K Cable suitable for use in photovoltaic installations	p. 140
TRATOS RG26H1M16 SLIMPOWER HT 105 Cable suitable for energy transmission between transformer rooms and big power users	p. 142
TRATOS SLIMPOWER PLUS HT 105 RG26H1M16X-12/20 kV RG26H1M16X-18/30 kV Cable suitable for energy transmission between transformer rooms and big power users	p. 146
TRATOS ARG7H1M1 SLIMPOWER HT 105 Cable suitable for energy transmission between transformer rooms and big power users	p. 150
TRATOS RG16H1R12-1,8/3 kV ÷ 26/45 kV — TRATOS RG16H1OR12-1,8/3 kV ÷ 26/45 kV Cable suitable for energy transmission between transformer rooms and big power users	p. 154
TRATOS RG7H1R — TRATOS RG7H1OR Cable suitable for energy transmission between transformer rooms and big power users	p. 168

TRATOS ARG7H1R — TRATOS ARG7H1OR	
Cable suitable for energy transmission between transformer rooms and big power users.	p. 182
TRATOS ARG7H1EX	
Cable suitable for energy transmission between transformer rooms and big power users.	p. 192
TRATOS ARG7H1RX	
Cable suitable for energy transmission between transformer rooms and big power users.	p. 194
TRATOS RG7(H1)OZR	
Cable suitable for energy transmission between transformer rooms and big power users.	p. 198
TRATOS RG7H1ONR	
Cable suitable for energy transmission between transformer rooms and big power users.	p. 206
TRATOS RG7H1RNRX	
Cable suitable for energy transmission between transformer rooms and big power users.	p. 210
TRATOS ARG7H1RNR — TRATOS ARG7H1RNRX	
Cable suitable for energy transmission between transformer rooms and big power users.	p. 212
TRATOS RE4H1(AF)R	
Cable suitable for energy transmission between transformer rooms and big power users.	p. 218
TRATOS U-1000 R2V	
Cable suitable for cases of high operating temperatures.	p. 220
TRATOS U-1000 AR2V	
Cable suitable for cases of high operating temperatures.	p. 226
TRATOS FR-N1X1G1-U/R	
Cable suitable for use in public and industrial settings.	p. 230
TRATOS SYT+DIGITAL	
Cable suitable for the connection of indoor telephone systems and digital data transmission lines.	p. 234
TRATOS SYS	
Cable suitable for the connection of indoor telephone systems and digital data transmission lines.	p. 236
TRATOS NYM-J	
Cable suitable for use in industrial electrical systems.	p. 238
TRATOS NHXMH-J/O	
Cable suitable for use electrical circuits located in fire risk areas.	p. 240
TRATOS YSLY-JZ/OZ	
Cable suitable for use in dry, humid or wet environments subject to moderate mechanical loads.	p. 242
TRATOS YSLY-JB/OB	
Cable suitable for use in dry, humid or wet environments subject to moderate mechanical loads.	p. 246
TRATOS YSLY CY-JZ/OZ	
Cable suitable for use in dry, humid or wet environments subject to moderate mechanical loads.	p. 250
TRATOS YSLY CY-JB/OB	
Cable suitable for use in dry, humid or wet environments subject to moderate mechanical loads.	p. 254
TRATOS YSLY-JZ/OZ 0,6/1 kV	
Cable suitable for energy supply in industry, workshops and residential building.	p. 256

TRATOS YSLY-JB/OB 0,6/1 kV Cable suitable for energy supply in industry, workshops and residential building	p. 260
TRATOS YSLY CY-JZ/OZ 0,6/1 kV Cable suitable for energy supply in industry, workshops and residential building	p. 262
TRATOS HSLH-JZ/OZ Cable suitable for use as control cable in cases of particular fire safety requirements	p. 264
TRATOS HSLH-JB/OB Cable suitable for use as control cable in cases of particular fire safety requirements	p. 268
TRATOS HSLCH-JZ/OZ Cable suitable for use as control cable in cases of particular fire safety requirements	p. 270
TRATOS 2XSLCYK-J / 2XSLCYK-J 3-PLUS Cable particularly recommended for motor power supplies	p. 274
TRATOS 2YSLCY(K)-J / 2YSLCY(K)-J 3-PLUS Cable particularly recommended for motor power supplies	p. 276
TRATOS YCY Cable suitable for connecting telephone and signalling systems	p. 278
TRATOS HCH Cable suitable for connection of telephone systems	p. 279
TRATOS J-Y(St)Y Lg Cable suitable for telecommunications and data processing systems	p. 280
TRATOS J-Y(St)Y Lg Brandmeldekabel Cable suitable for telecommunications and data processing systems	p. 282
TRATOS J-H(St)H Bd Cable suitable for telephone, measuring, and technological control systems	p. 284
TRATOS J-H(St)H Bd Brandmeldekabel Cable suitable for telephone, measuring, and technological control systems	p. 286
TRATOS XVB Cable suitable for use in dry or humid indoor contexts with a fire risk	p. 288
TRATOS EXVB Cable suitable for fixed installation in industrial and civil	p. 292
TRATOS XGB Cable suitable for fire risk areas	p. 294
TRATOS VVT Cable suitable for indoor connection of telephone equipment in places at risk of fire	p. 298
TRATOS TT Cable suitable for in industrial electrical systems	p. 300
TRATOS FE0 D Cable suitable in places where is necessary to protect against the emission of fumes, toxic and corrosive gases	p. 302
TRATOS FE05C Cable suitable for fire risk areas	p. 304

TRATOS AT-N05VV-U (YM-J/O) Cable suitable for permanent installation in dry, damp or wet rooms	p. 306
TRATOS MMJ Cable suitable for energy supply in industry, workshops, residential building, and in agricultural applications	p. 308
TRATOS MMJ-HF Cable suitable for use in public and industrial settings	p. 310
TRATOS EXQ TRI-LIGHT Cable suitable for use in public and industrial settings	p. 312
TRATOS XMCMK Cable suitable for photovoltaic electrical system	p. 314
TRATOS S1XZ1-U/R Cable suitable for energy transmission in fire risk areas	p. 316
TRATOS ELQYB Cable suitable for telecommunication, safety and alarm systems in fire risk environments	p. 318
TRATOS YDY Cable suitable for laying in industrial and home installation, on and under the plaster	p. 320
TRATOS YDYp Cable suitable for fixed wiring in power equipment, in dry rooms on plaster and under plaster	p. 322
TRATOS N2XY Cable suitable for permanent installations indoors and outdoors, in cable canals and directly in the ground	p. 324
TRATOS MTO Cable suitable for power supply connections to all types of mobile equipment and vehicles	p. 326
TRATOS XPJ Cable suitable for energy supply in industry, workshops, residential building, and in agricultural applications	p. 328
TRATOS RAME COTTO CLASSE 2 Cable suitable for ground systems	p. 330

STANDARDS AND QUALITY SYSTEM

QUALITY SYSTEM

Tratos aim to work closely with customers to find better, more environmentally friendly solutions to their challenges.

We are committed to our vision and strategy to serve all our internal and external customers by providing high quality services and products. Tratos is an established industry leader in the design, manufacture and supply of cables and products and to maintain this leading position we are committed at every level to providing our customers with quality services and products at a competitive price. As a commercial enterprise we are aware of the importance of satisfying our customers and of the financial impact of which nonconformities may have on our profitability. For these reasons we are committed to complying with all customer requirements and specifications both legal and statutory requirements. Our Quality Management System has been audited and approved by two independent, Internationally recognized and accepted authorities: BSI and AENOR-IQNET (E), in accordance to BS EN ISO 9001:2015 covering the production, purchasing of raw materials design and final test including various document types. The Tratos Quality Management system is under frequent regular surveillance by inspectors working for the Certification Authorities.



As a commercial enterprise we are aware of the importance of satisfying our customers and of the financial impact of which nonconformities may have on our profitability. For these reasons we are committed to complying with all customer requirements and specifications both legal and statutory requirements. Our Quality Management System has been audited and approved by two independent, Internationally recognized and accepted authorities: BSI and AENOR-IQNET (E), in accordance to BS EN ISO 9001:2015 covering the production, purchasing of raw materials design and final test including various document types. The Tratos Quality Management system is under frequent regular surveillance by inspectors working for the Certification Authorities.

ENVIRONMENTAL SYSTEM

Our Environmental Management System has been audited and approved by two independent, Internationally recognized and accepted authorities:

BSI and AENOR-IQNET (E), in accordance to BS EN ISO 14001:2015 covering the production, purchasing of raw materials design and final test including various document types. The Tratos Quality Management system is under frequent regular surveillance by inspectors working for the Certification Authorities.



ENERGY MANAGEMENT SYSTEMS

By complying with the BS EN ISO 50001:2018 Tratos follows a systematic approach in achieving continual improvement of energy performance and the Energy Management Systems (EnMS).

The BS EN ISO 50001:2018 is a standard issued by the International Standard Organization (ISO) which outlines the requirements for establishing, implementing, maintaining and improving an energy management system (EnMS).



CIRCULAR ECONOMY

The EU Eco-Management and Audit Scheme (EMAS) is a premium management instrument developed by the European Commission for companies and other organisations to evaluate, report, and improve their environmental performance. EMAS is open to every type of organisation eager to improve its environmental performance. It spans all economic and service sectors and is applicable worldwide.



AWARDS

Tratos cables are made with award winning Tratos-JBA® compound. Tratos UK Ltd has won a **Queen's Award for Enterprise - Innovation** for its technologically advanced Tratos-JBA® compound.



STANDARDS AND QUALITY SYSTEM

HEALTHY & SAFETY SYSTEM

Once its decision to create a board post dedicated to furthering best practice for Health and Safety, international cable manufacturer Tratos is celebrating receipt of ISO 45001 by two independent, Internationally recognized and accepted authorities: BSI and AENOR-IQNET (E). ISO 45001 sets out the minimum requirements for occupational health and safety management best practice and helps companies achieve the maximum return for employees, operations and customers.



REACH, WEEE & ROHS



Tratos is fully compliant with the **REACH**. This is a European Union regulation concerning the **Registration, Evaluation, Authorisation and restriction of Chemicals**. It came into force on 1st June 2007 and replaced a number of European Directives and Regulations with a single system. REACH applies to substances manufactured or imported into the EU in quantities of 1 tonne or more per year. Generally, it applies to all individual chemical substances on their own, in preparations or in articles. To summarise, REACH makes the cable industry directly responsible for assessing and managing the risks posed by chemicals and providing safety information to their users.



Tratos fully subscribes to The **Waste Electrical and Electronic Equipment Directive (WEEE Directive)**, introduced into UK law in January 2007 by the Waste Electronic and Electrical Equipment Regulations 2006. The WEEE Directive aims to reduce the amount of electrical and electronic equipment being produced and to encourage everyone to reuse, recycle and recover it. The WEEE Directive also aims to improve the environmental performance of businesses that manufacture, supply, use, recycle and recover electrical and electronic equipment. TRATOS has enlisted the services of the UK's leading producer compliance scheme, Valpak, whom manage our recycling obligations and also ensure our compliance to the WEEE Regulations and the Waste Batteries and Accumulators Regulations.



Tratos is fully compliant with the **Restriction of Hazardous Substances (RoHS) Regulations**. These Regulations implement EU Directive 2011/65/EU which bans the placing on the EU market of new electrical and electronic equipment containing more than agreed levels of lead, cadmium, mercury, hexavalent chromium, polybrominated biphenyl (PBB) and polybrominated diphenyl ether (PBDE) flame retardants. Tratos fully understands the requirements of the RoHS Directive and ensures that our products, and their components, comply.

CORPORATE SOCIAL RESPONSIBILITY

Tratos adopts a Code of Ethics which adheres to the United Nations Global Compact on human rights, labour standards, protection of the environment and anti corruption measures.

Under this self regulatory code, Tratos will carry out initiatives in the environmental and social fields with special reference to environmental policies and social policies regarding child labour, compulsory labour, health and security, freedom of association and the right to collective bargaining, discrimination, disciplinary procedures, working hours and wages.

APPROVALS

Reeling cables made by Tratos have been tested and certified by the following Approval Organisations:



Verband Der Elektrotechnik



Instituto Marchio di Qualità



Lloyd's Register Group



Underwriters Laboratories Inc.®



EAC - Eurasian Conformity



Registro Italiano Navale

H05V-K / H07V-K cable

TRATOS H05V-K TRATOS H07V-K

Reference Guide EN 50565

H05V-K: for fixed laying in above-ground or built-in pipes only if used for signalling or control circuits. Contact with water is not permitted.

H07V-K: for fixed laying in above-ground or built-in pipes or in similar closed systems. Cable suitable for protected installation in lighting and control appliances for voltage up to 1000V in a.c. or up to 750 V in d.c. landward. Contact with water is not permitted.

Reference Construction Products Regulation 305/2011 EU and Standard EN 50575:

The cable is suitable for the supply of electricity in buildings and other civil engineering works.

FEATURES AND PERFORMANCES

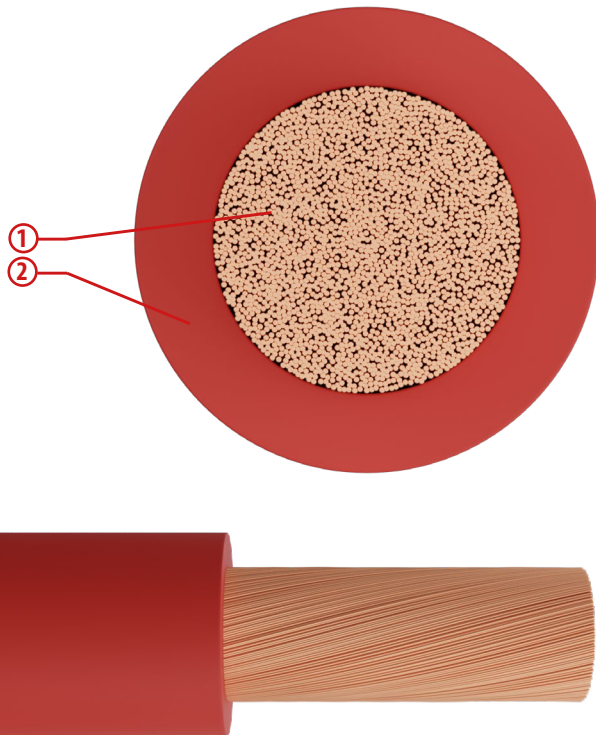

CONSTRUCTION

1. CLASS 5, FLEXIBLE, PLAIN COPPER WIRE
2. PVC, TI1 QUALITY

Structure and electrical, physical, mechanical requirements: EN 50525-2-31 (IEC 60227-3)

- Low Voltage Directive 2014/35/EU
- RoHS Directive 2011/65/EU

Special features

Good sliding properties in pipes, good abrasion resistance, easy stripping.

Cable Marking

Tratos H05V-K IEMMEQU [HAR] [year]
Tratos H07V-K IEMMEQU [HAR] [year]

Functional characteristics

Rated voltage - H05V-K: U _o /U	300/500 V
Rated voltage- H07V-K: U _o /U	450/750 V
Max. operating temperature	70°C
Min. operating temperature	-10°C (without mechanical shocks)
Max. short circuit temperature	160°C

Installation conditions

Minimum installation temperature	5°C
Recommended min. bending radius	4 times the cable diameter
Recommended maximum tensile stress	50 N/mm ² of the cross-section of the copper

H05V-K

Formation	Ø approx. conductor	Average insulation thickness	External Ø	Max. electrical resistance at 20°C	Approx. cable weight	Current rating in pipe in air at 30°C
n° x mm ²	mm	mm	mm	Ω/km	kg/km	A
1 x 0,5	0,9	0,6	2,5	39,0	9	3
1 x 0,75	1,1	0,6	2,7	26,0	11	6
1 x 1	1,3	0,6	2,8	19,5	14	10

H07V-K

Formation	Ø approx. conductor	Average insulation thickness	External Ø	Max. electrical resistance at 20°C	Approx. cable weight	Current rating in pipe in air at 30°C
n° x mm ²	mm	mm	mm	Ω/km	kg/km	A
1 x 1,5	1,5	0,7	3,4	13,3	20	16
1 x 2,5	2,0	0,8	4,1	7,98	31	20
1 x 4	2,5	0,8	4,8	4,95	45	25
1 x 6	3,0	0,8	5,3	3,30	64	36
1 x 10	4,0	1,0	6,8	1,91	110	50
1 x 16	5,0	1,0	8,1	1,21	160	68
1 x 25	6,2	1,2	10,2	0,780	250	89
1 x 35	7,4	1,2	11,7	0,554	340	110
1 x 50	8,9	1,4	13,9	0,386	480	134
1 x 70	10,5	1,4	16,0	0,272	670	171
1 x 95	12,2	1,6	18,2	0,206	870	207
1 x 120	13,8	1,6	20,2	0,161	1100	239
1 x 150	15,4	1,8	22,5	0,129	1370	275
1 x 185	16,9	2,0	24,9	0,106	1680	314
1 x 240	19,5	2,2	28,4	0,0801	2205	369

N.B. Permissible current rating values are according to three charged conductors

H07V-U cable

TRATOS H07V-U

Reference Guide EN 50565

For fixed laying in above-ground or built-in pipes or in similar closed systems. Cable suitable for protected installation in lighting and control appliances for voltage up to 1000 V in a.c. or up to 750 V in d.c. landward. Contact with water is not permitted.

Reference Construction Products Regulation 305/2011 EU and Standard EN 50575:

The cable is suitable for the supply of electricity in buildings and other civil engineering works.

FEATURES AND PERFORMANCES

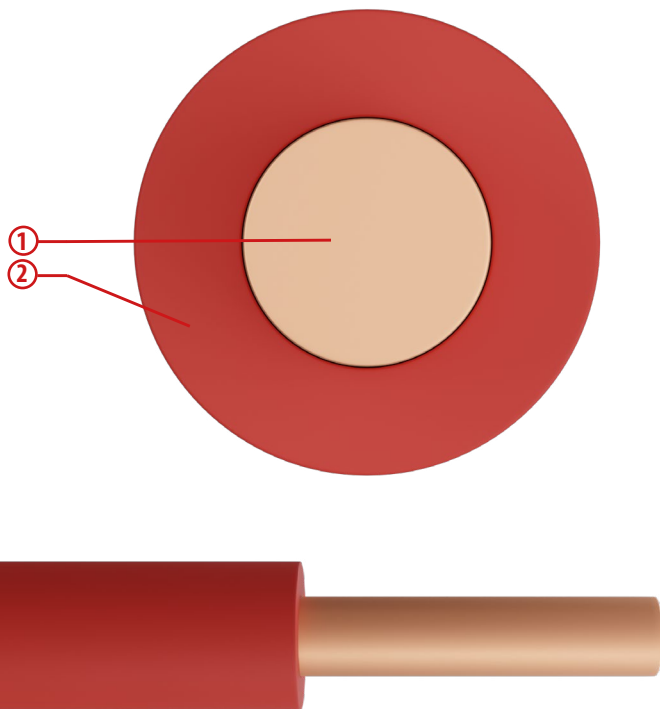

CONSTRUCTION

1. CLASS 1, SOLID, PLAIN COPPER
2. PVC, TI1 QUALITY

Structure and electrical, physical, mechanical requirements: EN 50525-2-31

- Low Voltage Directive 2014/35/EU
- RoHS Directive 2011/65/EU

Special features

Good sliding properties in pipes, good abrasion resistance, easy stripping.

Cable Marking

Tratos H07V-U IEMMEQU [HAR] [year]

Functional characteristics

Rated voltage U_0/U	450/750 V
Max. operating temperature	70°C
Min. operating temperature	-10°C (without mechanical shocks)
Max. short circuit temperature	160°C

Installation conditions

Minimum installation temperature	5°C
Recommended min. bending radius	6 times the cable diameter
Recommended maximum tensile stress	50 N/mm ² of the cross-section of the copper

H07V-U

Formation	Approx. conductor \emptyset	Average insulation thickness	Max. external \emptyset	Max. electrical resistance at 20°C	Approx. cable weight	Current rating in pipe in air at 30°C
n° x mm ²	mm	mm	mm	Ω /km	kg/km	A
1 x 1,5	1,4	0,7	3,2	12,1	19	16
1 x 2,5	1,8	0,8	3,9	7,41	30	20
1 x 4	2,3	0,8	4,4	4,61	44	25
1 x 6	2,8	0,8	5,0	3,08	63	36
1 x 10	3,5	1,0	6,4	1,83	110	50

N.B. Permissible current rating values are according to three charged conductors

H07V-R cable

TRATOS H07V-R

Reference Guide EN 50565

For fixed laying in above-ground or built-in pipes or in similar closed systems. Cable suitable for protected installation in lighting and control appliances for voltage up to 1000 V in a.c. or up to 750 V in d.c. landward. Contact with water is not permitted.

Reference Construction Products Regulation 305/2011 EU and Standard EN 50575:

The cable is suitable for the supply of electricity in buildings and other civil engineering works.

FEATURES AND PERFORMANCES

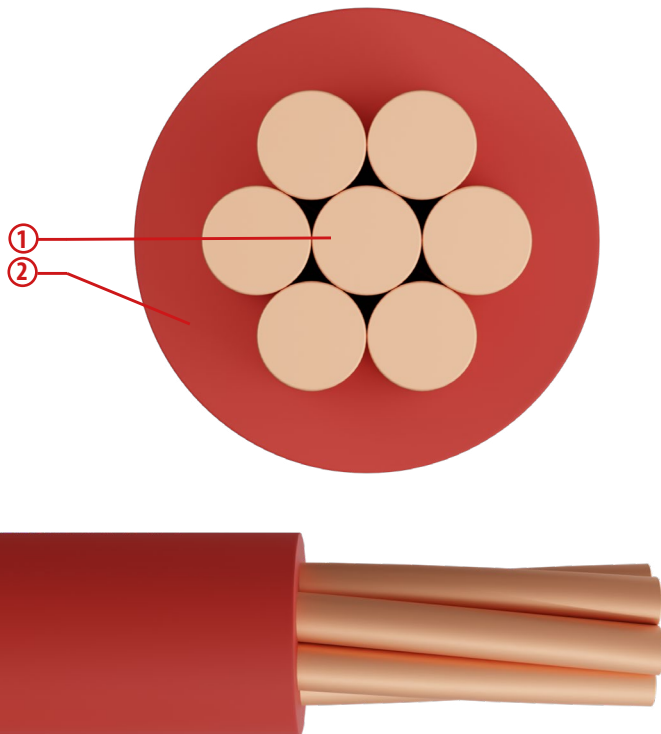

CONSTRUCTION

1. CLASS 2, STRANDED WIRE, PLAIN COPPER
2. PVC, TI1 QUALITY

Structure and electrical, physical, mechanical requirements: EN 50525-2-31

- Low Voltage Directive 2014/35/EU
- RoHS Directive 2011/65/EU

Special features

Good sliding properties in pipes, good abrasion resistance, easy stripping.

Cable Marking

Tratos H07V-R IEMMEQU [HAR] [year]

Functional characteristics

Rated voltage U ₀ /U	450/750 V
Max. operating temperature	70°C
Min. operating temperature	-10°C (without mechanical shocks)
Max. short circuit temperature	160°C

Installation conditions

Minimum installation temperature	5°C
Recommended min. bending radius	6 times the cable diameter
Recommended maximum tensile stress	50 N/mm ² of the cross-section of the copper

H07V-R

Formation	Approx. conductor \emptyset	Average insulation thickness	Max. external \emptyset	Max. electrical resistance at 20°C	Approx. cable weight	Current rating in pipe in air at 30°C
n° x mm ²	mm	mm	mm	Ω /km	kg/km	A
1 x 1,5	1,6	0,7	3,3	12,1	21	16
1 x 2,5	2,0	0,8	4,0	7,41	33	20
1 x 4	2,4	0,8	4,6	4,61	48	25
1 x 6	3,1	0,8	5,2	3,08	67	36
1 x 10	4,0	1,0	6,7	1,83	110	50
1 x 16	4,8	1,0	7,8	1,15	165	68
1 x 25	6,0	1,2	9,7	0,727	260	89
1 x 35	7,0	1,2	10,9	0,524	355	110
1 x 50	8,1	1,4	12,8	0,387	480	134
1 x 70	9,7	1,4	14,6	0,268	670	171
1 x 95	11,4	1,6	17,1	0,193	925	207
1 x 120	13,1	1,6	18,8	0,153	1165	239
1 x 150	14,6	1,8	20,9	0,124	1405	275
1 x 185	16,5	2,0	23,3	0,0991	1800	314
1 x 240	18,5	2,2	26,6	0,0754	2330	369
1 x 300	21,0	2,4	29,6	0,0601	2950	425

N.B. Permissible current rating values are according to three charged conductors

TRATOS General Cables®

H05V2-K / H07V2-K cable

TRATOS H05V2-K TRATOS H07V2-K

Reference Guide EN 50565

H05V2-K: Suitable for installations inside lighting devices, in which the max. conductor temperature under normal usage conditions does not exceed 90°C. Installation permitted in aboveground or built-in pipes if used for signalling and control circuits only. Contact with water is not permitted.

H07V2-K: Suitable for installations in above ground or built-in pipes or similar closed systems, in which the max. conductor temperature under normal usage conditions does not exceed 90°C. If installed in supply systems, the max. continuous operating temperature has to be 70°C. For fixed and protected installations in lighting and control devices, rated voltages up to 1000 V in AC or up to 750 V in DC landward are permitted. Contact with water is not permitted.

Reference Construction Products Regulation 305/2011 EU and Standard EN 50575:

The cable is suitable for the supply of electricity in buildings and other civil engineering works.

FEATURES AND PERFORMANCES

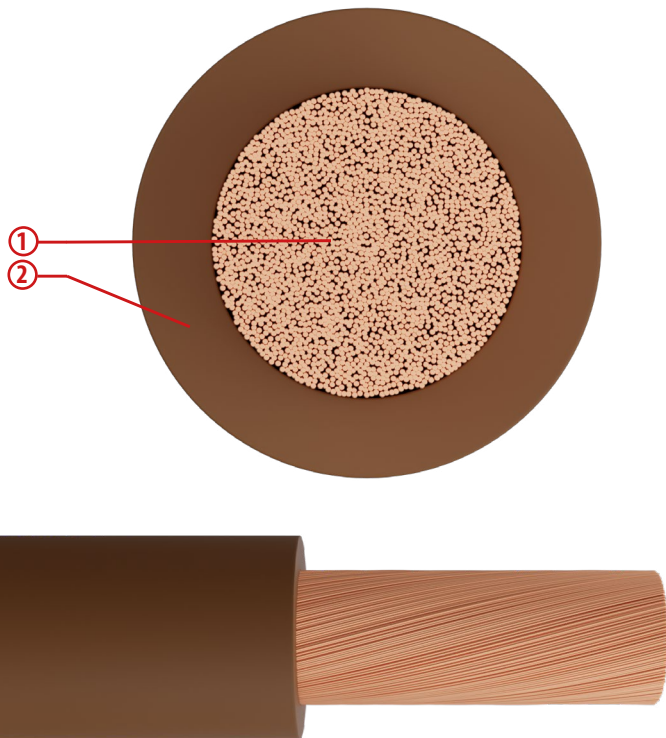

CONSTRUCTION

1. CLASS 5, FLEXIBLE, PLAIN COPPER WIRE
2. SPECIAL 90°C PVC, T13 QUALITY

Structure and electrical, physical, mechanical requirements: EN 50525-2-31

- Low Voltage Directive 2014/35/EU
- RoHS Directive 2011/65/EU

Special features

Good sliding properties in pipes, good abrasion resistance, easy stripping.

Cable Marking

Tratos H05V2-K IEMMEQU[HAR] [year]
Tratos H07V2-K IEMMEQU [HAR][year]

Functional characteristics

Rated voltage - H05V2-K: U _o /U	300/500 V
Rated voltage - H07V2-K: U _o /U	450/750 V
Max. operating temperature	90°C
Min. operating temperature	-10°C (without mechanical shocks)
Max. short circuit temperature	160°C

Installation conditions

Minimum installation temperature	5°C
Recommended min. bending radius	4 times the cable diameter
Recommended maximum tensile stress	50 N/mm ² of the cross-section of the copper

H05V2-K

Formation	Approx. conductor \emptyset	Average insulation thickness	Max. external \emptyset	Max. electrical resistance at 20°C	Approx. cable weight	Current rating in pipe in air at 30°C
n° x mm ²	mm	mm	mm	Ω /km	kg/km	A
1 x 0,5	0,9	0,6	2,5	39,0	9	3
1 x 0,75	1,1	0,6	2,7	26,0	11	6
1 x 1	1,3	0,6	2,8	19,5	14	10

H07V2-K

Formation	Approx. conductor \emptyset	Average insulation thickness	Max. external \emptyset	Max. electrical resistance at 20°C	Approx. cable weight	Current rating in pipe in air at 30°C
n° x mm ²	mm	mm	mm	Ω /km	kg/km	A
1 x 1,5	1,5	0,7	3,4	13,3	19	16
1 x 2,5	2,0	0,8	4,1	7,98	29	20
1 x 4	2,5	0,8	4,8	4,95	43	25
1 x 6	3,0	0,8	5,3	3,30	61	48
1 x 10	4,0	1,0	6,8	1,91	105	66
1 x 16	5,0	1,0	8,1	1,21	155	88
1 x 25	6,2	1,2	10,2	0,780	240	117
1 x 35	7,4	1,2	11,7	0,554	330	144

N.B. Permissible current rating values are according to three charged conductors

H05V2-U cable

TRATOS H05V2-U

Reference Guide EN 50565

Suitable for installations inside lighting devices, in which the max. conductor temperature under normal usage conditions does not exceed 90°C. Installation permitted in aboveground or built-in pipes if used for signalling and control circuits only. Contact with water is not permitted.

N.B. For applications not covered by Regulation EU 305/2011.

FEATURES AND PERFORMANCES

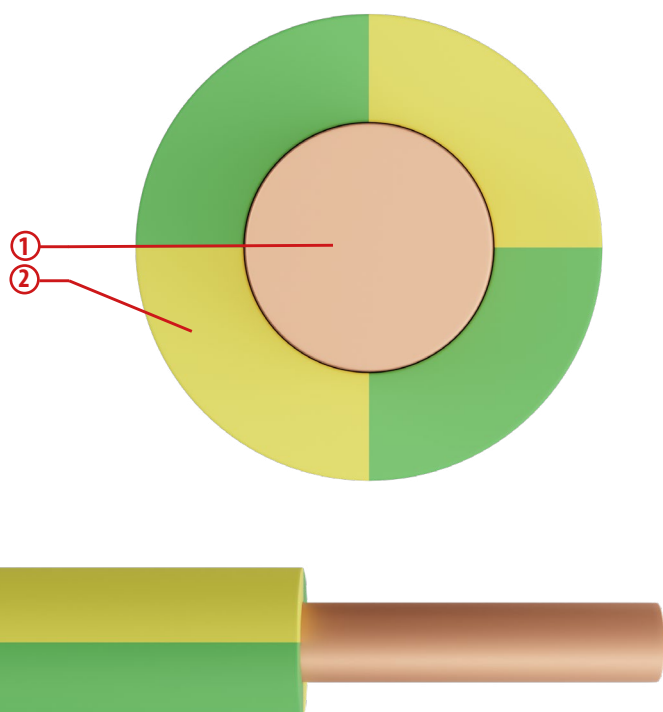

CONSTRUCTION

1. CLASS 1, SOLID, PLAIN COPPER
2. PVC SPECIALE 90°C, T13 QUALITY

Structure and electrical, physical, mechanical requirements: EN 50525-2-31

- Flame propagation EN 60332-1-2
- Low Voltage Directive 2014/35/EU
- RoHS Directive 2011/65/EU

Special features

Good sliding properties in pipes, good abrasion resistance, easy stripping.

Cable Marking

Tratos H05V2-U IEMMEQU [HAR] [year]

Functional characteristics

Rated voltage : U _o /U	300/500 V
Max. operating temperature	90°C
Min. operating temperature	-10°C (without mechanical shocks)
Max. short circuit temperature	160°C

Installation conditions

Minimum installation temperature	5°C
Recommended min. bending radius	6 times the cable diameter
Recommended maximum tensile stress	50 N/mm ² of the cross-section of the copper

Formation	Approx. conductor Ø	Average insulation thickness	Max. external Ø	Max. electrical resistance at 20°C	Approx. cable weight	Current rating in pipe in air at 30°C
n° x mm ²	mm	mm	mm	Ω/km	kg/km	A
1 x 0,5	0,8	0,6	2,3	36,0	8	3
1 x 0,75	1,0	0,6	2,5	24,5	10	6
1 x 1	1,15	0,6	2,7	18,1	14	10

H07V2-U cable

TRATOS H07V2-U

Reference Guide EN 50565

Suitable for installations in above ground or built-in pipes or similar closed systems, in which the max. conductor temperature under normal usage conditions does not exceed 90°C. If installed in supply systems, the max. continuous operating temperature has to be 70°C. For fixed and protected installations in lighting and control devices, rated voltages up to 1000 V in AC or up to 750 V in DC landward are permitted. Contact with water is not permitted.

Reference Construction Products Regulation 305/2011 EU and Standard EN 50575:

The cable is suitable for the supply of electricity in buildings and other civil engineering works.

FEATURES AND PERFORMANCES

CONSTRUCTION

1. CLASS 1, SOLID, PLAIN COPPER
2. PVC SPECIALE 90°C, TI3 QUALITY

Structure and electrical, physical, mechanical requirements: EN 50525-2-31

- **Low Voltage Directive** 2014/35/EU
- **RoHS Directive** 2011/65/EU

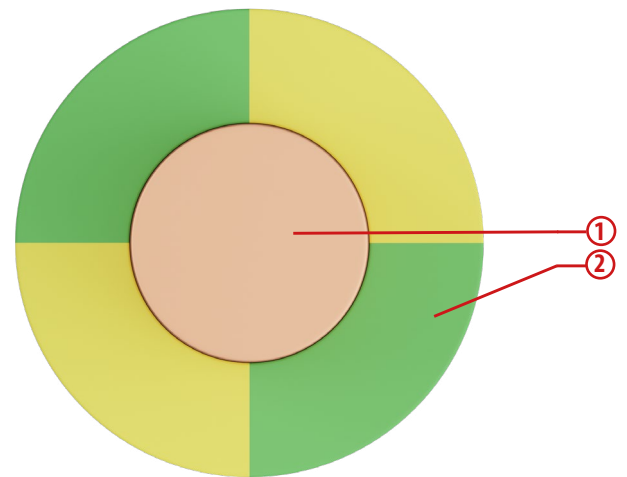

Special features

Good sliding properties in pipes, good abrasion resistance, easy stripping.

Cable Marking

Tratos H07V2-U IEMMEQU [HAR] [year]

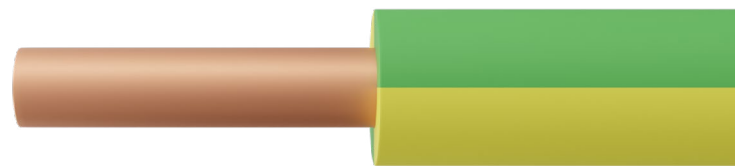

Functional characteristics	
Rated voltage : U _o /U	450/750 V
Max. operating temperature	90°C
Min. operating temperature	-10°C (without mechanical shocks)
Max. short circuit temperature	160°C

Installation conditions	
Minimum installation temperature	5°C
Recommended min. bending radius	6 times the cable diameter
Recommended maximum tensile stress	50 N/mm ² of the cross-section of the copper

Formation	Approx. conductor \varnothing	Average insulation thickness	Max. external \varnothing	Max. electrical resistance at 20°C	Approx. cable weight	Current rating in pipe in air at 30°C
n° x mm ²	mm	mm	mm	Ω /km	kg/km	A
1 x 1,5	1,4	0,7	3,2	12,1	19	16
1 x 2,5	1,8	0,8	3,9	7,41	29	20

N.B. Permissible current rating values are according to three charged conductors

H07V2-R cable

TRATOS H07V2-R

Reference Guide EN 50565

Suitable for installations in aboveground or built-in pipes or similar closed systems, in which the max. conductor temperature under normal usage conditions does not exceed 90°C. If installed in supply systems, the max. continuous operating temperature has to be 70°C. For fixed and protected installations in lighting and control devices, rated voltages up to 1000 V in a.c. or up to 750 V in d.c. landward are permitted. Contact with water is not permitted.

Reference Construction Products Regulation 305/2011 EU and Standard EN 50575:

The cable is suitable for the supply of electricity in buildings and other civil engineering works.

FEATURES AND PERFORMANCES

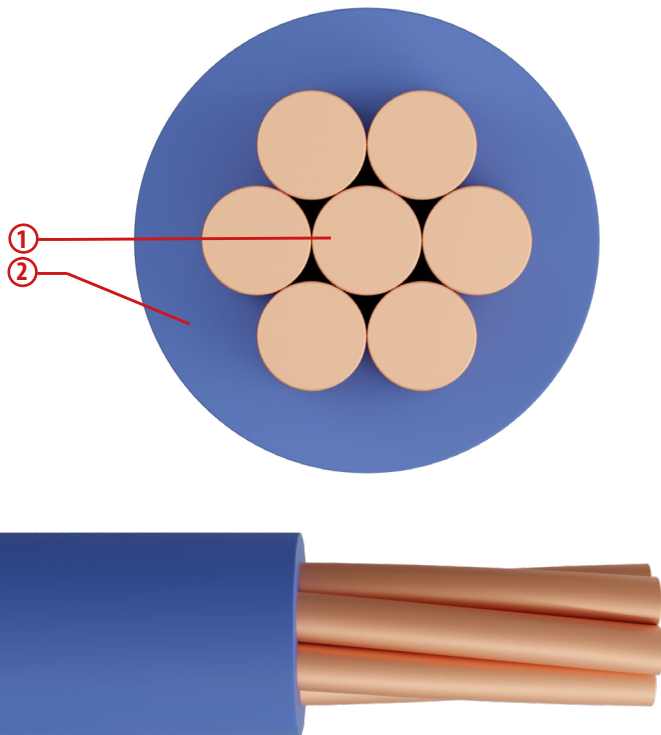

CONSTRUCTION

1. CLASS 2, STRANDED WIRE, PLAIN COPPER
2. PVC SPECIAL 90°C, T13 QUALITY

Structure and electrical, physical, mechanical requirements: EN 50525-2-31

- Low Voltage Directive 2014/35/EU
- RoHS Directive 2011/65/EU

Special features

Good sliding properties in pipes, good abrasion resistance, easy stripping.

Cable Marking

Tratos H07V2-R IEMMEQU[HAR] [year]

Functional characteristics

Rated voltage: U _o /U	450/750 V
Max. operating temperature	90°C
Min. operating temperature	-10°C (without mechanical shocks)
Max. short circuit temperature	160°C

Installation conditions

Minimum installation temperature	5°C
Recommended min. bending radius	6 times the cable diameter
Recommended maximum tensile stress	50 N/mm ² of the cross-section of the copper

H07V2-R

Formation	Approx. conductor \emptyset	Average insulation thickness	Max. external \emptyset	Max. electrical resistance at 20°C	Approx. cable weight	Current rating in pipe in air at 30°C
n° x mm ²	mm	mm	mm	Ω /km	kg/km	A
1 x 1,5	1,6	0,7	3,3	12,1	20	16
1 x 2,5	2,0	0,8	4,0	7,41	31	20
1 x 4	2,4	0,8	4,6	4,61	47	25
1 x 6	3,1	0,8	5,2	3,08	66	48
1 x 10	4,0	1,0	6,7	1,83	110	66
1 x 16	4,8	1,0	7,8	1,15	170	88
1 x 25	6,0	1,2	9,7	0,727	260	117

N.B. Permissible current rating values are according to three charged conductors

TRATOS General Cables®

H05Z-K / H07Z-K cable

TRATOS H05Z-K TRATOS H07Z-K

Reference Guide EN 50565

For environments containing large number of people (schools, offices, theatres, subways, hospitals, place of worship, malls and places of entertainment) when it is necessary to protect against the emission of fumes and corrosive gases in case of fire. The presence of water in contact with cable is not acceptable.

H05Z-K: for fixed laying in above-ground or built-in pipes only if used for signalling or control circuits.

H07Z-K: for fixed laying in above-ground or built-in pipes or in similar closed systems. Cable suitable for protected installation in lighting and control appliances for voltage up to 1000V in a.c. or up to 750 V in d.c. landward.

Reference Construction Products Regulation 305/2011 EU and Standard EN 50575:

Given its properties of limiting the development of fire and heat emission, the cable is suitable for the supply of electricity in buildings and other civil engineering works.

FEATURES AND PERFORMANCES

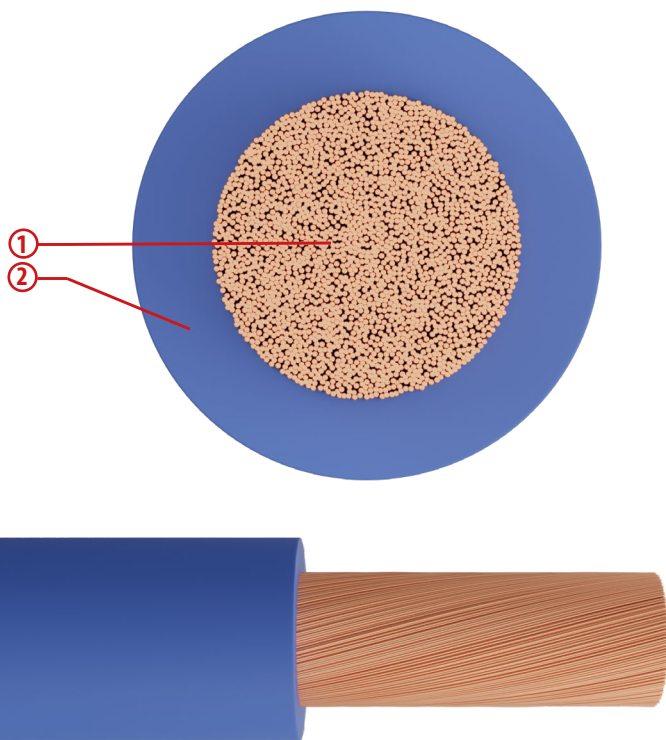

CONSTRUCTION

1. CLASS 5, FLEXIBLE, PLAIN COPPER WIRE
2. LS0H CROSS-LINKED ELASTOMER, EI5 QUALITY

LS0H = Low Smoke Zero Halogen

Structure and electrical, physical, mechanical requirements: EN 50525-3-41

• Corrosive gases or halogens	EN 50267-2-1
	EN 50267-2-2
	EN 60684-2
	IEC 60684-2
• Smoke density (transmittance)	EN 61034-2
• Low Voltage Directive	2014/35/EU
• RoHS Directive	2011/65/EU

Special features

Good sliding properties in pipes, good abrasion resistance, easy stripping.

Cable Marking

Tratos H05Z-K IEMMEQU[HAR] [year]

Tratos H07Z-K IEMMEQU[HAR] [year]

Functional characteristics

Rated voltage H05Z-K: U ₀ /U	300/500 V
Rated voltage H07Z-K: U ₀ /U	450/750 V
Max. operating temperature	90°C
Min. operating temperature	-20°C (without mechanical shocks)
Max. short circuit temperature	250°C

Installation conditions

Minimum installation temperature	-5°C
Recommended min. bending radius	4 times the cable diameter
Recommended maximum tensile stress	50 N/mm ² of the cross-section of the copper

H05Z-K

Formation	Approx. conductor \emptyset	Average insulation thickness	Max. external \emptyset	Max. electrical resistance at 20°C	Approx. cable weight	Current rating in pipe in air at 30°C
n° x mm ²	mm	mm	mm	Ω /km	kg/km	A
1 x 0,5	0,9	0,6	2,6	39,0	8	3
1 x 0,75	1,1	0,6	2,8	26,0	10	6
1 x 1	1,3	0,6	2,9	19,5	14	10

H07Z-K

Formation	Approx. conductor \emptyset	Average insulation thickness	Max. external \emptyset	Max. electrical resistance at 20°C	Approx. cable weight	Current rating in pipe in air at 30°C
n° x mm ²	mm	mm	mm	Ω /km	kg/km	A
1 x 1,5	1,5	0,7	3,5	13,3	19	20
1 x 2,5	2,0	0,8	4,3	7,98	30	28
1 x 4	2,5	0,8	4,9	4,95	43	37
1 x 6	3,0	0,8	5,5	3,30	61	48
1 x 10	4,0	1,0	7,1	1,91	110	66
1 x 16	5,0	1,0	8,4	1,21	155	88
1 x 25	6,2	1,2	10,6	0,780	240	117
1 x 35	7,4	1,2	12,1	0,554	330	144
1 x 50	8,9	1,4	14,4	0,386	480	175
1 x 70	10,5	1,4	16,6	0,272	680	222
1 x 95	12,2	1,6	18,8	0,206	860	269
1 x 120	13,8	1,6	20,9	0,161	1080	312
1 x 150	15,4	1,8	23,3	0,129	1345	355
1 x 185	16,9	2,0	25,8	0,106	1650	417
1 x 240	19,5	2,2	29,4	0,0801	2180	490

N.B. Permissible current rating values are according to three charged conductors

H05Z-U/ H07Z-U cable

TRATOS H05Z-U TRATOS H07Z-U

Reference Guide EN 50565

For environments containing large number of people (schools, offices, theatres, subways, hospitals, place of worship, malls and places of entertainment) when it is necessary to protect against the emission of fumes and corrosive gases in case of fire. The presence of water in contact with cable is not acceptable.

H05Z-U: for fixed laying in above-ground or built-in pipes only if used for signalling or control circuits. Contact with water is not permitted.

H07Z-U: for fixed laying in above-ground or built-in pipes or in similar closed systems. Cable suitable for protected installation in lighting and control appliances for voltage up to 1000V in a.c. or up to 750 V in d.c. landward.

Reference Construction Products Regulation 305/2011 EU and Standard EN 50575:

Given its properties of limiting the development of fire and heat emission, the cable is suitable for the supply of electricity in buildings and other civil engineering works.

FEATURES AND PERFORMANCES

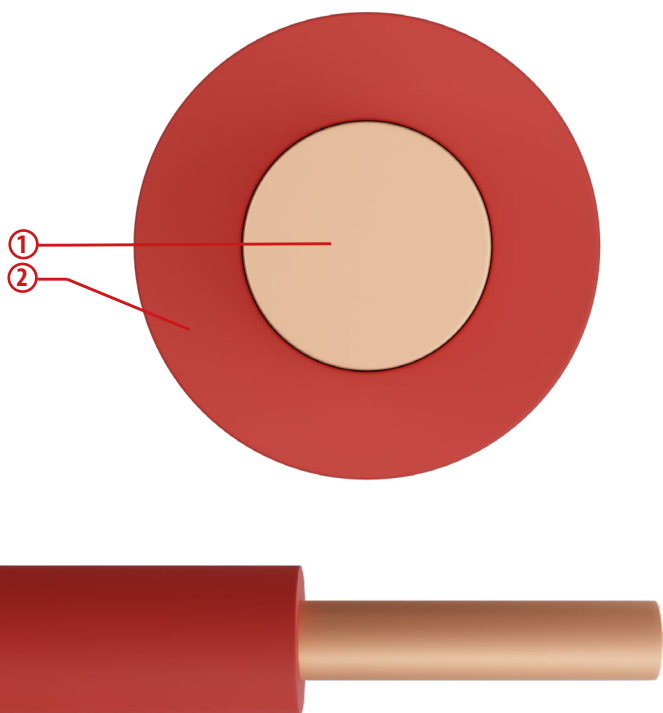

CONSTRUCTION

1. CLASS 1, SOLID, PLAIN COPPER
2. LS0H CROSS-LINKED ELASTOMER, EI5 QUALITY

LS0H = Low Smoke Zero Halogen

Structure and electrical, physical, mechanical requirements: EN 50525-3-41

- Corrosive gases or halogens
 - EN 50267-2-1
 - EN 50267-2-2
 - EN 60684-2
- Smoke density (transmittance)
 - EN 61034-2
- Low Voltage Directive
 - 2014/35/EU
- RoHS Directive
 - 2011/65/EU

Special features

Good sliding properties in pipes, good abrasion resistance, easy stripping.

Cable Marking

Tratos H05Z-U IEMMEQU[HAR] [year]

Tratos H07Z-U IEMMEQU[HAR] [year]

Functional characteristics

Rated voltage H05Z-K: U ₀ /U	300/500 V
Rated voltage H07Z-K: U ₀ /U	450/750 V
Max. operating temperature	90°C
Min. operating temperature	-20°C (without mechanical shocks)
Max. short circuit temperature	250°C

Installation conditions

Minimum installation temperature	-5°C
Recommended min. bending radius	6 times the cable diameter
Recommended maximum tensile stress	50 N/mm ² of the cross-section of the copper

H05Z-U

Formation	Approx. conductor \emptyset	Average insulation thickness	Max. external \emptyset	Max. electrical resistance at 20°C	Approx. cable weight	Current rating in pipe in air at 30°C
n° x mm ²	mm	mm	mm	Ω /km	kg/km	A
1 x 0,5	0,8	0,6	2,4	36,0	8	3
1 x 0,75	1,0	0,6	2,6	24,5	10	6
1 x 1	1,15	0,6	2,8	18,1	13	10

H07Z-U

Formation	Approx. conductor \emptyset	Average insulation thickness	Max. external \emptyset	Max. electrical resistance at 20°C	Approx. cable weight	Current rating in pipe in air at 30°C
n° x mm ²	mm	mm	mm	Ω /km	kg/km	A
1 x 1,5	1,4	0,7	3,3	12,1	19	20
1 x 2,5	1,8	0,8	4,0	7,41	29	28
1 x 4	2,3	0,8	4,6	4,61	43	37
1 x 6	2,8	0,8	5,2	3,08	62	48

N.B. Permissible current rating values are according to three charged conductors

H07Z-R cable

TRATOS H07Z-R

Reference Guide EN 50565

For environments containing large number of people (schools, offices, theatres, subways, hospitals, place of worship, malls and places of entertainment) when it is necessary to protect against the emission of fumes and corrosive gases in case of fire. For fixed laying in above-ground or built-in pipes or in similar closed systems. Cable suitable for protected installation in lighting and control appliances for voltage up to 1000V in a.c. or up to 750 V in d.c. landward. The presence of water in contact with cable is not acceptable.

Reference Construction Products Regulation 305/2011 EU and Standard EN 50575:

Given its properties of limiting the development of fire and heat emission, the cable is suitable for the supply of electricity in buildings and other civil engineering works.

FEATURES AND PERFORMANCES

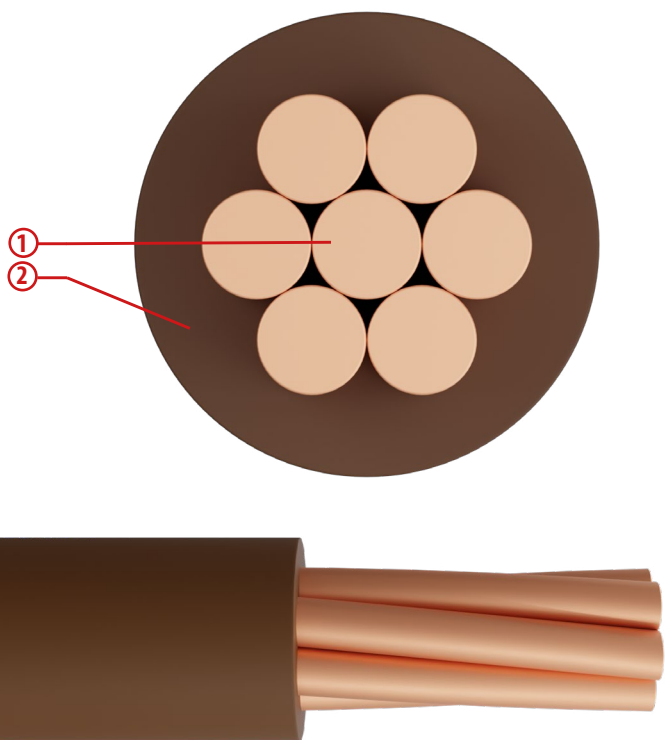

CONSTRUCTION

1. CLASS 2, STRANDED WIRE, PLAIN COPPER
2. LSOH CROSS-LINKED ELASTOMER, EI5 QUALITY

LSOH = Low Smoke Zero Halogen

Structure and electrical, physical, mechanical requirements: EN 50525-3-41

- Corrosive gases or halogens
 - EN 50267-2-1
 - EN 50267-2-2
 - EN 60684-2
- Smoke density (transmittance)
 - EN 61034-2
- Low Voltage Directive
 - 2014/35/EU
- RoHS Directive
 - 2011/65/EU

Special features

Good sliding properties in pipes, good abrasion resistance, easy stripping.

Cable Marking

6491B Tratos H07Z-R IEMMEQU[HAR] [year]

Functional characteristics

Rated voltage: U ₀ /U	450/750 V
Max. operating temperature	90°C
Min. operating temperature	-20°C (without mechanical shocks)
Max. short circuit temperature	250°C

Installation conditions

Minimum installation temperature	5°C
Recommended min. bending radius	6 times the cable diameter
Recommended maximum tensile stress	50 N/mm ² of the cross-section of the copper

H07Z-R

Formation	Approx. conductor \emptyset	Average insulation thickness	Max. external \emptyset	Max. electrical resistance at 20°C	Approx. cable weight	Current rating in pipe in air at 30°C
n° x mm ²	mm	mm	mm	Ω /km	kg/km	A
1 x 1,5	1,6	0,7	3,4	12,1	20	20
1 x 2,5	2,0	0,8	4,1	7,41	32	28
1 x 4	2,4	0,8	4,7	4,61	47	37
1 x 6	3,1	0,8	5,4	3,08	66	48
1 x 10	4,0	1,0	7,0	1,83	110	66
1 x 16	4,8	1,0	8,0	1,15	165	88
1 x 25	6,0	1,2	10,1	0,727	260	117
1 x 35	7,0	1,2	11,3	0,524	350	144
1 x 50	8,1	1,4	13,2	0,387	470	175
1 x 70	9,7	1,4	15,1	0,268	665	222
1 x 95	11,4	1,6	17,6	0,193	920	269
1 x 120	13,1	1,6	19,4	0,153	1155	312
1 x 150	14,6	1,8	21,6	0,124	1405	355
1 x 185	16,5	2,0	24,1	0,0991	1790	417
1 x 240	18,5	2,2	27,5	0,0754	2310	490
1 x 300	21,0	2,4	30,6	0,0601	2890	590
1 x 400	23,4	2,6	34,3	0,0470	3840	720

N.B. Permissible current rating values are according to three charged conductors

H07Z1-K Type 2 (D_{ca}) cable

TRATOS H07Z1-K Type 2 (D_{ca})

Reference Guide EN 50565

Suitable for environments containing a large number of people, when special fire performances are necessary or where local conditions or regulations require increased levels of public safety, a low level of smoke emission, toxic and corrosive gases. Suitable for fixed protected installations in lighting and control gear for voltages up to 1000 V a.c. or up to 750 V d.c. to earth. For installations in surface-mounted or embedded conduits or similar closed systems. It can be installed in bunches. The presence of water in contact with cable is not acceptable.

Reference Construction Products Regulation 305/2011 EU and Standard EN 50575:

Given its properties of limiting the development of fire and heat emission, the cable is suitable for the supply of electricity in buildings and other civil engineering works.

FEATURES AND PERFORMANCES

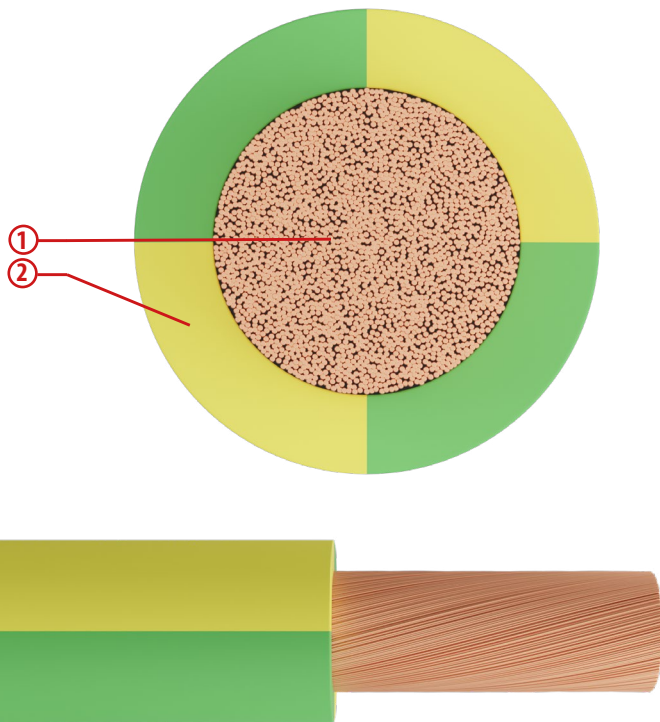

CONSTRUCTION

1. CLASS 5, FLEXIBLE, PLAIN COPPER WIRE
2. LS0H TERMOPLASTIC, TI7 QUALITY

LS0H = Low Smoke Zero Halogen

Structure and electrical, physical, mechanical requirements: EN 50525-3-31

- Fire propagation EN 60332-3-24
- Corrosive gases or halogens EN 50267-2-1
EN 50267-2-2
EN 60684-2
- Smoke density (transmittance) EN 61034-2
- Low Voltage Directive 2014/35/EU
- RoHS Directive 2011/65/EU

Special features

Good sliding properties in pipes, good abrasion resistance, easy stripping.

Cable Marking

Tratos H07Z1-K TYPE 2 IEMMEQU[HAR] [year]

Functional characteristics

Rated voltage: U ₀ /U	450/750 V
Max. operating temperature	70°C
Min. operating temperature	-10°C (without mechanical shocks)
Max. short circuit temperature	160°C

Installation conditions

Minimum installation temperature	5°C
Recommended min. bending radius	4 times the cable diameter
Recommended maximum tensile stress	50 N/mm ² of the cross-section of the copper

H07Z1-K Type 2 (D_{ca})

Formation	Approx. conductor \emptyset	Average insulation thickness	Max. external \emptyset	Max. electrical resistance at 20°C	Approx. cable weight	Current rating in pipe in air at 30°C
n° x mm ²	mm	mm	mm	Ω /km	kg/km	A
1 x 1,5	1,5	0,7	3,4	13,3	19	15,5
1 x 2,5	2,0	0,8	4,1	7,98	30	21
1 x 4	2,5	0,8	4,8	4,95	44	28
1 x 6	3,0	0,8	5,3	3,30	62	36
1 x 10	4,0	1,0	6,8	1,91	105	50
1 x 16	5,0	1,0	8,1	1,21	155	68
1 x 25	6,2	1,2	10,2	0,780	245	89
1 x 35	7,4	1,2	11,7	0,554	335	110
1 x 50	8,9	1,4	13,9	0,386	475	134
1 x 70	10,5	1,4	16,0	0,272	660	171
1 x 95	12,2	1,6	18,2	0,206	865	207
1 x 120	13,8	1,6	20,2	0,161	1090	239
1 x 150	15,4	1,8	22,5	0,129	1360	275
1 x 185	16,9	2,0	24,9	0,106	1660	314
1 x 240	19,5	2,2	28,4	0,0801	2190	369

N.B. Permissible current rating values are according to three charged conductors

H07Z1-K Type 2 (C_{ca}) cable

TRATOS H07Z1-K Type 2 (C_{ca})

Reference Guide EN 50565

Suitable for environments containing a large number of people, when special fire performances are necessary or where local conditions or regulations require increased levels of public safety, a low level of smoke emission, toxic and corrosive gases. Suitable for fixed protected installations in lighting and control gear for voltages up to 1000 V a.c. or up to 750 V d.c. to earth. For installations in surface-mounted or embedded conduits or similar closed systems. It can be installed in bunches. The presence of water in contact with cable is not acceptable.

Reference Construction Products Regulation 305/2011 EU and Standard EN 50575:

Given its properties of limiting the development of fire and heat emission, the cable is suitable for the supply of electricity in buildings and other civil engineering works.

FEATURES AND PERFORMANCES

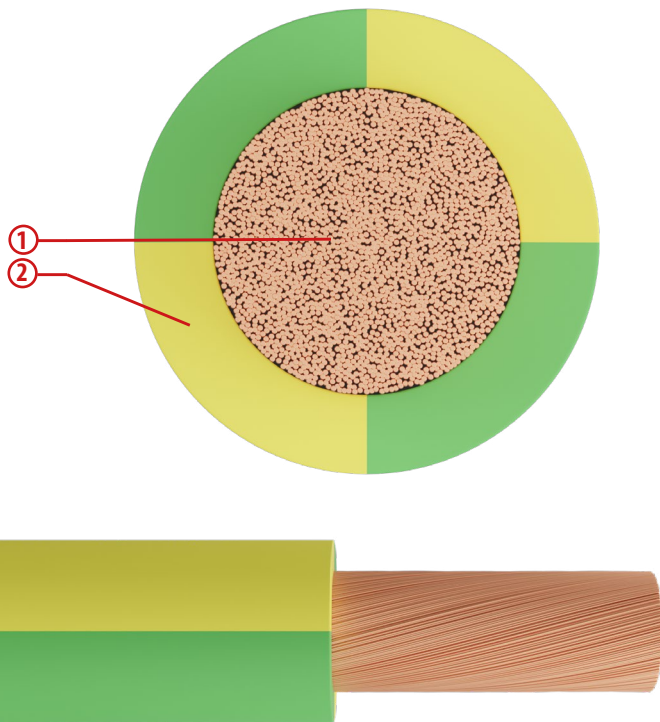

CONSTRUCTION

1. CLASS 5, FLEXIBLE, PLAIN COPPER WIRE
2. LS0H TERMOPLASTIC, TI7 QUALITY

LS0H = Low Smoke Zero Halogen

Structure and electrical, physical, mechanical requirements: EN 50525-3-31

- Fire propagation EN 60332-3-24
- Corrosive gases or halogens EN 50267-2-1
EN 50267-2-2
EN 60684-2
- Low Voltage Directive 2014/35/EU
- RoHS Directive 2011/65/EU

Special features

Good sliding properties in pipes, good abrasion resistance, easy stripping.

Cable Marking

Tratos H07Z1-K TYPE 2 IEMMEQU[HAR] [year]

Functional characteristics

Rated voltage: U ₀ /U	450/750 V
Max. operating temperature	70°C
Min. operating temperature	-10°C (without mechanical shocks)
Max. short circuit temperature	160°C

Installation conditions

Minimum installation temperature	5°C
Recommended min. bending radius	4 times the cable diameter
Recommended maximum tensile stress	50 N/mm ² of the cross-section of the copper

H07Z1-K Type 2 (C_{ca})

Formation	Approx. conductor \emptyset	Average insulation thickness	Max. external \emptyset	Max. electrical resistance at 20°C	Approx. cable weight	Current rating in pipe in air at 30°C
n° x mm ²	mm	mm	mm	Ω /km	kg/km	A
1 x 1,5	1,5	0,7	3,4	13,3	20	15,5
1 x 2,5	2,0	0,8	4,1	7,98	32	21
1 x 4	2,5	0,8	4,8	4,95	46	28
1 x 6	3,0	0,8	5,3	3,30	65	36
1 x 10	4,0	1,0	6,8	1,91	109	50
1 x 16	5,0	1,0	8,1	1,21	162	68
1 x 25	6,2	1,2	10,2	0,780	252	89
1 x 35	7,4	1,2	11,7	0,554	345	110
1 x 50	8,9	1,4	13,9	0,386	492	134
1 x 70	10,5	1,4	16,0	0,272	682	171
1 x 95	12,2	1,6	18,2	0,206	893	207
1 x 120	13,8	1,6	20,2	0,161	1124	239
1 x 150	15,4	1,8	22,5	0,129	1406	275
1 x 185	16,9	2,0	24,9	0,106	1715	314
1 x 240	19,5	2,2	28,4	0,0801	2264	369
1 x 300 *	22,0	2,4	/	0,0641	2784	424
1 x 400 *	26,0	2,6	/	0,0486	3806	487

N.B. Permissible current rating values are according to a three charged conductors

* FORMATIONS WITHOUT CERTIFICATION <HAR>

H07Z1-U Type 2 (D_{ca}) cable

TRATOS H07Z1-U Type 2 (D_{ca})

Suitable for environments containing a large number of people, when special fire performances are necessary or where local conditions or regulations require increased levels of public safety, a low level of smoke emission, toxic and corrosive gases. Suitable for fixed protected installations in lighting and control gear for voltages up to 1000 V a.c. or up to 750 V d.c. to earth.

For installations in surface-mounted or embedded conduits or similar closed systems. It can be installed in bunches. The presence of water in contact with cable is not acceptable.

Reference Construction Products Regulation 305/2011 EU and Standard EN 50575:

Given its properties of limiting the development of fire and heat emission, the cable is suitable for the supply of electricity in buildings and other civil engineering works.

FEATURES AND PERFORMANCES

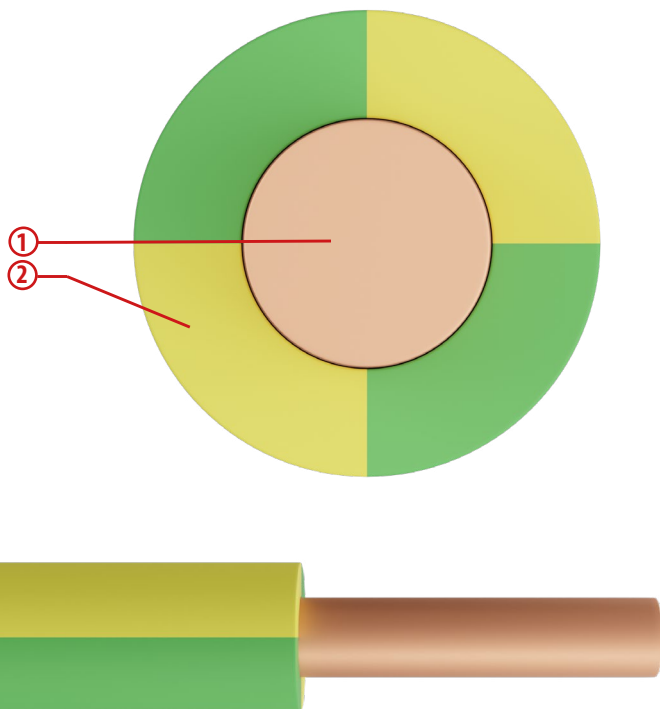

CONSTRUCTION

1. CLASS 1, SOLID, PLAIN COPPER
2. LS0H TERMOPLASTIC, T17 QUALITY

LS0H = Low Smoke Zero Halogen

Structure and electrical, physical, mechanical requirements: EN 50525-3-31

- **Fire propagation** EN 60332-3-24
(CEI 20-22 III)
- **Corrosive gases or halogens** EN 50267-2-1
EN 50267-2-2
EN 60684-2
- **Smoke density (transmittance)** EN 61034-2
- **Low Voltage Directive** 2014/35/EU
- **RoHS Directive** 2011/65/EU

Special features

Good sliding properties in pipes, good abrasion resistance, easy stripping.

Cable Marking

Tratos H07Z1-U TYPE 2 IEMMEQU[HAR] [year]

Functional characteristics

Rated voltage: U _o /U	450/750 V
Max. operating temperature	70°C
Min. operating temperature	-10°C (without mechanical shocks)
Max. short circuit temperature	160°C

Installation conditions

Minimum installation temperature	5°C
Recommended min. bending radius	6 times the cable diameter
Recommended maximum tensile stress	50 N/mm ² of the cross-section of the copper

H07Z1-U Type 2 (D_{ca})

Formation	Approx. conductor \emptyset	Average insulation thickness	Max. external \emptyset	Max. electrical resistance at 20°C	Approx. cable weight	Current rating in pipe in air at 30°C
n° x mm ²	mm	mm	mm	Ω /km	kg/km	A
1 x 1,5	1,4	0,7	3,2	12,1	20	16
1 x 2,5	1,8	0,8	3,9	7,41	30	20
1 x 4	2,3	0,8	4,4	4,61	44	25

N.B. Permissible current rating values are according to a three charged conductors

H05Z1-K (C_{ca}) cable

TRATOS H05Z1-K (C_{ca})

Reference Guide EN 50565

For environments containing large number of people, where a low level of smoke emission and toxic and corrosive gases are required in case of fire or burning. Suitable for fixed protected installation inside appliances and lighting fittings. For installation in surface-mounted or embedded conduits or similar closed systems when used only for signalling or control circuits. The presence of water in contact with cable is not acceptable.

Reference Construction Products Regulation 305/2011 EU and Standard EN 50575:

Given its properties of limiting the development of fire and heat emission, the cable is suitable for the supply of electricity in buildings and other civil engineering works.

FEATURES AND PERFORMANCES

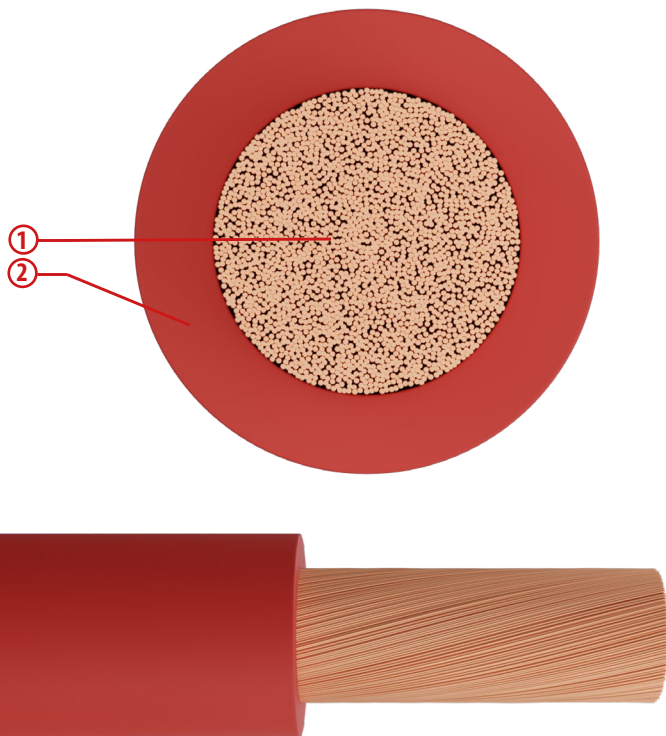

CONSTRUCTION

1. CLASS 5, FLEXIBLE, PLAIN COPPER WIRE
2. LSOH TERMOPLASTIC, T17 QUALITY

LSOH = Low Smoke Zero Halogen

Structure and electrical, physical, mechanical requirements: EN 50525-3-31

- **Corrosive gases or halogens** EN 50267-2-1
EN 50267-2-2
EN 60684-2
- **Low Voltage Directive** 2014/35/EU
- **RoHS Directive** 2011/65/EU

Special features

Good sliding properties in pipes, good abrasion resistance, easy stripping.

Cable Marking

Tratos H05Z1-K IEMMEQU[HAR] [year]

Functional characteristics

Rated voltage: U ₀ /U	300/500 V
Max. operating temperature	70°C
Min. operating temperature	-10°C (without mechanical shocks)
Max. short circuit temperature	160°C

Installation conditions

Minimum installation temperature	5°C
Recommended min. bending radius	4 times the cable diameter
Recommended maximum tensile stress	50 N/mm ² of the cross-section of the copper

H05Z1-K (C_{ca})

Formation	Approx. conductor \emptyset	Average insulation thickness	Max. external \emptyset	Max. electrical resistance at 20°C	Approx. cable weight	Current rating in pipe in air at 30°C
n° x mm ²	mm	mm	mm	Ω /km	kg/km	A
1 x 1	1,3	0,6	2,8	19,5	14	10

H07Z1-U Type 2 (C_{ca}) cable

TRATOS H07Z1-U Type 2 (C_{ca})

Suitable for environments containing a large number of people, when special fire performances are necessary or where local conditions or regulations require increased levels of public safety, a low level of smoke emission, toxic and corrosive gases. Suitable for fixed protected installations in lighting and control gear for voltages up to 1000 V a.c. or up to 750 V d.c. to earth. For installations in surface-mounted or embedded conduits or similar closed systems. It can be installed in bunches. The presence of water in contact with cable is not acceptable.

Reference Construction Products Regulation 305/2011 EU and Standard EN 50575:

Given its properties of limiting the development of fire and heat emission, the cable is suitable for the supply of electricity in buildings and other civil engineering works.

FEATURES AND PERFORMANCES

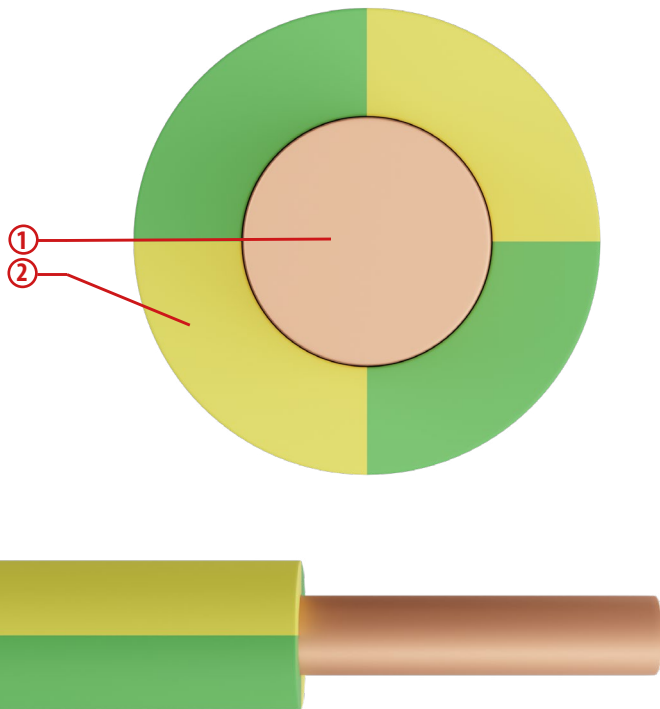

CONSTRUCTION

1. CLASS 1, SOLID, PLAIN COPPER
2. LS0H TERMOPLASTIC, T17 QUALITY

LS0H = Low Smoke Zero Halogen

Structure and electrical, physical, mechanical requirements: EN 50525-3-31

• Fire propagation	EN 60332-3-24 (CEI 20-22 III)
• Corrosive gases or halogens	EN 50267-2-1 EN 50267-2-2 EN 60684-2
• Smoke density (transmittance)	EN 61034-2
• Low Voltage Directive	2014/35/EU
• RoHS Directive	2011/65/EU

Special features

Good sliding properties in pipes, good abrasion resistance, easy stripping.

Cable Marking

Tratos H07Z1-U TYPE 2 IEMMEQU[HAR] [year]

Functional characteristics

Rated voltage: U ₀ /U	450/750 V
Max. operating temperature	70°C
Min. operating temperature	-10°C (without mechanical shocks)
Max. short circuit temperature	160°C

Installation conditions

Minimum installation temperature	5°C
Recommended min. bending radius	6 times the cable diameter
Recommended maximum tensile stress	50 N/mm ² of the cross-section of the copper

H07Z1-U Type 2 (C_{ca})

Formation	Approx. conductor \emptyset	Average insulation thickness	Max. external \emptyset	Max. electrical resistance at 20°C	Approx. cable weight	Current rating in pipe in air at 30°C
n° x mm²	mm	mm	mm	Ω/km	kg/km	A
1 x 1,5	1,4	0,7	3,2	12,1	20	16
1 x 2,5	1,8	0,8	3,9	7,41	30	20
1 x 4	2,3	0,8	4,4	4,61	44	25

N.B. Permissible current rating values are according to a three-phase circuit

H07Z1-R Type 2 (D_{ca}) cable

TRATOS H07Z1-R Type 2 (D_{ca})

Reference Guide EN 50565:

Suitable for environments containing a large number of people, when special fire performances are necessary or where local conditions or regulations require increased levels of public safety, a low level of smoke emission, toxic and corrosive gases. Suitable for fixed protected installations in lighting and control gear for voltages up to 1000 V a.c. or up to 750 V d.c. to earth.

For installations in surface-mounted or embedded conduits or similar closed systems. It can be installed in bunches. The presence of water in contact with cable is not acceptable.

Reference Construction Products Regulation 305/2011 EU and Standard EN 50575:

Given its properties of limiting the development of fire and heat emission, the cable is suitable for the supply of electricity in buildings and other civil engineering works.

FEATURES AND PERFORMANCES

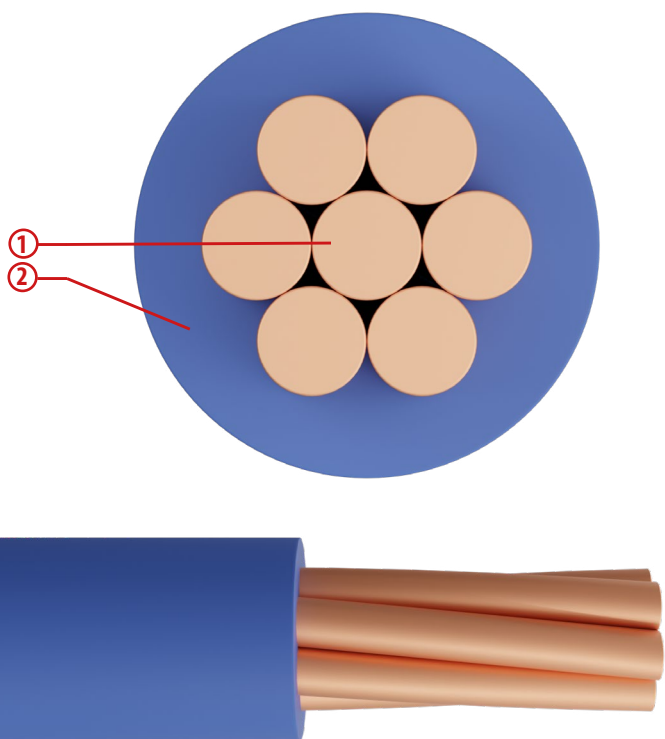

CONSTRUCTION

1. CLASS 2, STRANDED WIRE, PLAIN COPPER
2. LSOH TERMOPLASTIC, T17 QUALITY

LSOH = Low Smoke Zero Halogen

Structure and electrical, physical, mechanical requirements: EN 50525-3-31

• Fire propagation	EN 60332-3-24 (CEI 20-22 III)
• Corrosive gases or halogens	EN 50267-2-1 EN 50267-2-2 EN 60684-2
• Smoke density (transmittance)	EN 61034-2
• Low Voltage Directive	2014/35/EU
• RoHS Directive	2011/65/EU

Special features

Good sliding properties in pipes, good abrasion resistance, easy stripping.

Cable Marking

Tratos H07Z1-R TYPE 2 IEMMEQU[HAR] [year]

Functional characteristics

Rated voltage: U _o /U	450/750 V
Max. operating temperature	70°C
Min. operating temperature	-10°C (without mechanical shocks)
Max. short circuit temperature	160°C

Installation conditions

Minimum installation temperature	5°C
Recommended min. bending radius	6 times the cable diameter
Recommended maximum tensile stress	50 N/mm ² of the cross-section of the copper

H07Z1-R Type 2 (D_{ca})

Formation	Approx. conductor \emptyset	Average insulation thickness	Max. external \emptyset	Max. electrical resistance at 20°C	Approx. cable weight	Current rating in pipe in air at 30°C
n° x mm²	mm	mm	mm	Ω/km	kg/km	A
1 x 1,5	1,6	0,7	3,3	12,1	20	20
1 x 2,5	2,0	0,8	4,0	7,41	32	28
1 x 4	2,4	0,8	4,6	4,61	48	37

N.B. Permissible current rating values are according to a three-phase circuit

H07Z1-R Type 2 (C_{ca}) cable

TRATOS H07Z1-R Type 2 (C_{ca})

Reference Guide EN 50565:

Suitable for environments containing a large number of people, when special fire performances are necessary or where local conditions or regulations require increased levels of public safety, a low level of smoke emission, toxic and corrosive gases. Suitable for fixed protected installations in lighting and control gear for voltages up to 1000 V a.c. or up to 750 V d.c. to earth.

For installations in surface-mounted or embedded conduits or similar closed systems. It can be installed in bunches. The presence of water in contact with cable is not acceptable.

Reference Construction Products Regulation 305/2011 EU and Standard EN 50575:

Given its properties of limiting the development of fire and heat emission, the cable is suitable for the supply of electricity in buildings and other civil engineering works.

FEATURES AND PERFORMANCES

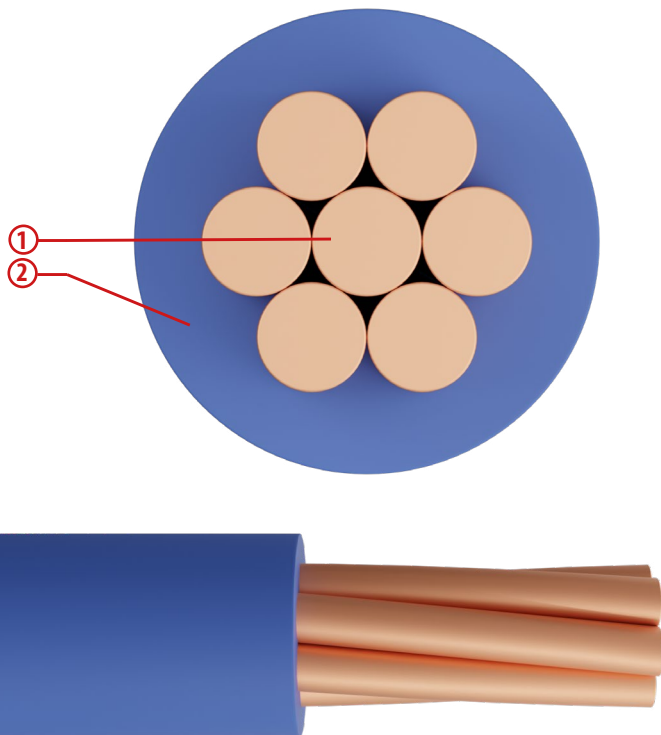

CONSTRUCTION

1. CLASS 2, STRANDED WIRE, PLAIN COPPER
2. LSOH TERMOPLASTIC, T17 QUALITY

LSOH = Low Smoke Zero Halogen

Structure and electrical, physical, mechanical requirements: EN 50525-3-31

• Fire propagation	EN 60332-3-24 (CEI 20-22 III)
• Corrosive gases or halogens	EN 50267-2-1 EN 50267-2-2 EN 60684-2
• Smoke density (transmittance)	EN 61034-2
• Low Voltage Directive	2014/35/EU
• RoHS Directive	2011/65/EU

Special features

Good sliding properties in pipes, good abrasion resistance, easy stripping.

Cable Marking

Tratos H07Z1-R TYPE 2 IEMMEQU[HAR] [year]

Functional characteristics

Rated voltage: U _o /U	450/750 V
Max. operating temperature	70°C
Min. operating temperature	-10°C (without mechanical shocks)
Max. short circuit temperature	160°C

Installation conditions

Minimum installation temperature	5°C
Recommended min. bending radius	6 times the cable diameter
Recommended maximum tensile stress	50 N/mm ² of the cross-section of the copper

H07Z1-R Type 2 (C_{ca})

Formation	Approx. conductor \emptyset	Average insulation thickness	Max. external \emptyset	Max. electrical resistance at 20°C	Approx. cable weight	Current rating in pipe in air at 30°C
n° x mm ²	mm	mm	mm	Ω /km	kg/km	A
1 x 1,5	1,6	0,7	3,3	12,1	21	20
1 x 2,5	2,0	0,8	4,0	7,41	33	28
1 x 4	2,4	0,8	4,6	4,61	48	37
1 x 6	3,1	0,8	5,2	3,08	67	48
1 x 10	4,0	1,0	6,7	1,83	110	66
1 x 16	4,8	1,0	7,8	1,15	165	88
1 x 25	6,0	1,2	9,7	0,727	260	117
1 x 35	7,0	1,2	10,9	0,524	355	144
1 x 50	8,1	1,4	12,8	0,387	480	175
1 x 70	9,7	1,4	14,6	0,268	675	222
1 x 95	11,4	1,6	17,1	0,193	930	269
1 x 120	13,1	1,6	18,8	0,153	1165	312
1 x 150	14,6	1,8	20,9	0,124	1415	355
1 x 185	16,5	2,0	23,3	0,0991	1805	417
1 x 240	18,5	2,2	26,6	0,0754	2330	490

N.B. Permissible current rating values are according to a three-phase circuit

TRATOS General Cables®

H03VV-F/ H05VV-F cable

TRATOS H03VV-F TRATOS H05VV-F

Reference Guide EN 50565

H03VV-F: For mobile use. Use in domestic premises and offices, for light duty applications and appliances (ex. music centers, table and standard lamps, office machines).

H05VV-F: For mobile use. Use in domestic premises and offices, for ordinary duty applications and household appliances, including in damp premises (ex. vacuum cleaners, washing machines, spin dryers and refrigerators). Use outdoor for temporary periods of short duration.

If both the cables are used inside equipment or the like where no contact with skin can be guaranteed the cables are suitable for maximum conductor operating temperature of 70°C.

Reference Construction Products Regulation 305/2011 EU and Standard EN 50575:

The cables are suitable for the supply of electricity in buildings and other civil engineering works.

FEATURES AND PERFORMANCES

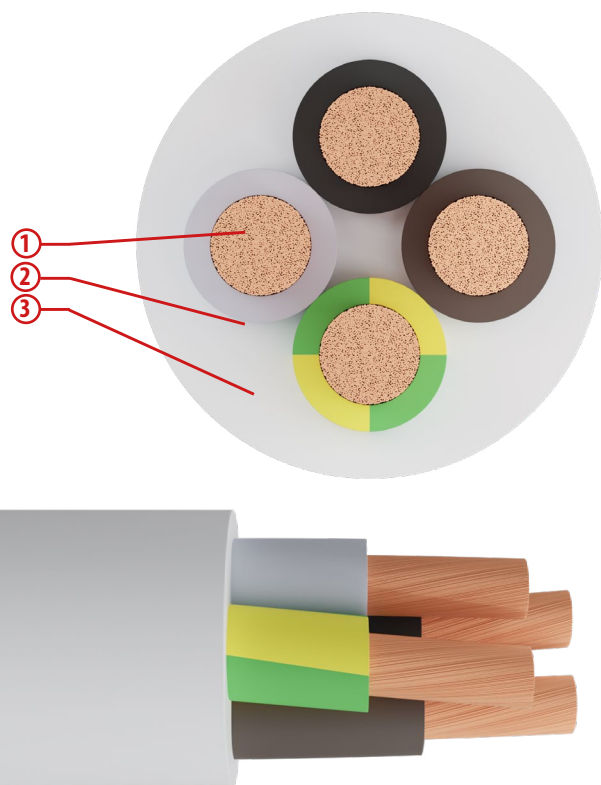

CONSTRUCTION

1. CLASS 5, FLEXIBLE, PLAIN COPPER WIRE
2. PVC, TI2 QUALITY
3. PVC, TM2 QUALITY

Structure and electrical, physical, mechanical requirements: EN 50525-2-11 (IEC 60227-5)

- Low Voltage Directive 2014/35/EU
- RoHS Directive 2011/65/EU

Functional characteristics

Rated voltage H03VV-F: U _o /U	300/300 V
Rated voltage H05VV-F: U _o /U	300/500 V
Max. operating temperature	90°C
Min. operating temperature	-10°C (without mechanical shocks)
Max. short circuit temperature	150°C

H03VV-F / Installation conditions

Minimum installation temperature	-5 °C
Recommended min. bending radius	6 times the cable diameter
Recommended maximum tensile stress	50 N/mm ² of the cross-section of the copper

H05VV-F / Installation conditions

Minimum installation temperature	5 °C
Recommended min. bending radius	6 times the cable diameter for mobile use, 4 times the cable diameter for static use
Recommended maximum tensile stress	15 N/mm ² of the cross-section of the copper for mobile use, 50 N/mm ² for static use

Cable Marking

Tratos IEMMEQU [HAR] H03VV-F [form]

Tratos IEMMEQU [HAR] H05VV-F [form]

Colours

TWO-CORE	● ●
THREE-CORE	● ● ● or ● ● ●
FOUR-CORE	● ● ● ● or ● ● ● ●
FIVE-CORE	● ● ● ● ● or ● ● ● ● ●

H03VV-F

Formation	Approx. conductor \emptyset	Average insulation thickness	Average sheath thickness	Approx. external \emptyset	Max. electrical resistance at 20°C	Approx. cable weight	Current rating in air at 30°C
n° x mm ²	mm	mm	mm	mm	Ω /km	kg/km	A
2 x 0,5	0,9	0,5	0,6	5,9	39,0	32	3
2 x 0,75	1,1	0,5	0,6	6,3	26,0	40	6
3G0,5	0,9	0,5	0,6	6,3	39,0	38	3
3G0,75	1,1	0,5	0,6	6,7	26,0	49	6
4G0,5	0,9	0,5	0,6	6,9	39,0	47	3
4G0,75	1,1	0,5	0,6	7,3	26,0	59	6

N.B. The values of current rating indicated apply in most cases

H05VV-F

Formation	Approx. conductor \emptyset	Average insulation thickness	Average sheath thickness	Approx. external \emptyset	Max. electrical resistance at 20°C	Approx. cable weight	Current rating in air at 30°C
n° x mm ²	mm	mm	mm	mm	Ω /km	kg/km	A
2 x 0,75	1,1	0,6	0,8	7,2	26,0	51	6
2 x 1	1,3	0,6	0,8	7,5	19,5	58	10
2 x 1,5	1,5	0,7	0,8	8,6	13,3	79	16
2 x 2,5	2,0	0,8	1,0	10,6	7,98	120	20
2 x 4	2,5	0,8	1,1	12,1	4,95	170	25
3G0,75	1,1	0,6	0,8	7,6	26,0	60	6
3G1	1,3	0,6	0,8	8,0	19,5	70	10
3G1,5	1,5	0,7	0,9	9,4	13,3	100	16
3G2,5	2,0	0,8	1,1	11,4	7,98	160	20
3G4	2,5	0,8	1,2	13,1	4,95	212	25
4G0,75	1,1	0,6	0,8	8,3	26,0	73	6
4G1	1,3	0,6	0,9	9,0	19,5	89	10
4G1,5	1,5	0,7	1,0	10,5	13,3	125	16
4G2,5	2,0	0,8	1,1	12,5	7,98	190	20
4G4	2,5	0,8	1,2	14,3	4,95	260	25
5G0,75	1,1	0,6	0,9	9,3	26,0	90	6
5G1	1,3	0,6	0,9	9,8	19,5	110	10
5G1,5	1,5	0,7	1,1	11,6	13,3	150	16
5G2,5	2,0	0,8	1,2	13,9	7,98	230	20
5G4	2,5	0,8	1,4	16,1	4,95	335	25

N.B. The values of current rating indicated apply in most cases

H03VVH2-F cable

TRATOS H03VVH2-F

Reference Guide EN 50565

For mobile use. Use in domestic premises and offices, for light duty applications and appliances (ex. music centers, table and standard lamps, office machines). If is used inside equipment or the like were no contact with skin can be guaranteed the the cables are suitable for maximum conductor operating temperature of 70°C.

Reference Construction Products Regulation 305/2011 EU and Standard EN 50575:

The cables are suitable for the supply of electricity in buildings and other civil engineering works.

FEATURES AND PERFORMANCES

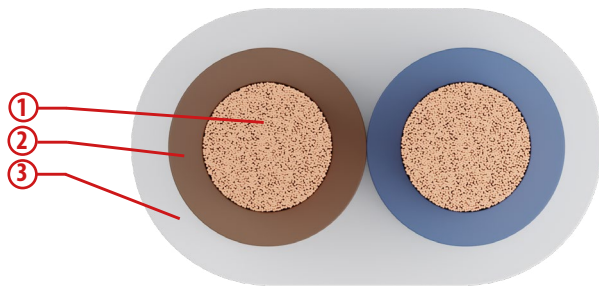

CONSTRUCTION

1. CLASS 5, FLEXIBLE, PLAIN COPPER WIRE
2. PVC, TI2 QUALITY
3. PVC, TM2 QUALITY, FLAT SHAPE

Structure and electrical, physical, mechanical requirements: EN 50525-2-11

- Low Voltage Directive 2014/35/EU
- RoHS Directive 2011/65/EU

Cable Marking

Tratos IEMMEQU[HAR] H03VVH2-F [year]

Colours

TWO-CORE ● ●

Functional characteristics

Rated voltage: U ₀ /U	300/300 V
Max. operating temperature	60°C
Min. operating temperature	-10°C (without mechanical shocks)
Max. short circuit temperature	150°C

Installation conditions

Minimum installation temperature	5°C
Recommended min. bending radius	6 times the cable diameter
Recommended maximum tensile stress	15 N/mm ² of the cross-section of the copper

Formation	Approx. conductor Ø	Average insulation thickness	Average sheath thickness	Max. external Ø	Max. electrical resistance at 20°C	Approx. cable weight	Current rating in pipe in air at 30°C
n° x mm ²	mm	mm	mm	mm	Ω/km	kg/km	A
2 x 0,5	0,9	0,5	0,6	3,7 x 5,9	39,0	26	3
2 x 0,75	1,1	0,5	0,6	3,8 x 6,3	26,0	32	6

N.B. Permissible current rating values are according to a three-phase circuit

H05VVH2-F cable

TRATOS H05VVH2-F

Reference Guide EN 50565

For mobile use. Use in domestic premises and offices, for ordinary duty applications and household appliances, including in damp premises (ex. vacuum cleaners, washing machines, spin dryers and refrigerators). Use outdoor for temporary periods of short duration. If is used inside equipment or the like were no contact with skin can be guaranteed the the cables are suitable for maximum conductor operating temperature of 70°C.

N.B. For applications not covered by Regulation EU 305/2011.

FEATURES AND PERFORMANCES

CONSTRUCTION

1. CLASS 5, FLEXIBLE, PLAIN COPPER WIRE
2. PVC, T12 QUALITY
3. PVC, TM2 QUALITY, FLAT SHAPE

Structure and electrical, physical, mechanical requirements: EN 50525-2-11

- **Flame propagation** EN 60332-1-2
- **Low Voltage Directive** 2014/35/EU
- **RoHS Directive** 2011/65/EU

Cable Marking

Tratos IEMMEQU[HAR] H05VVH2-F [year]

Colours

TWO-CORE ● ●

Functional characteristics	
Rated voltage: U _o /U	300/300 V
Max. operating temperature	60°C
Min. operating temperature	-10°C (without mechanical shocks)
Max. short circuit temperature	150°C

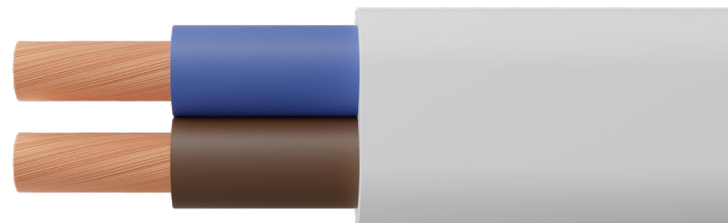
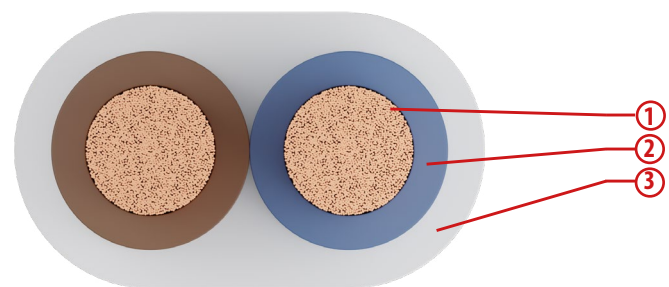

Installation conditions	
Minimum installation temperature	5°C
Recommended min. bending radius	6 times of the smaller dimension of the cable for mobile use, 4 times the smaller dimension of the cable for static use.
Recommended maximum tensile stress	15 N/mm ² of the cross-section of the copper for mobile use, 50 N/mm ² for static use

Formation	Approx. conductor Ø	Average insulation thickness	Average sheath thickness	Max. external Ø	Max. electrical resistance at 20°C	Approx. cable weight	Current rating in pipe in air at 30°C
n° x mm ²	mm	mm	mm	mm	Ω/km	kg/km	A
2 x 0,75	1,1	0,6	0,8	4,5 x 7,2	26,0	40	6
2 x 1	1,3	0,6	0,8	4,7 x 7,5	19,5	50	10

N.B. Permissible current rating values are according to a three-phase circuit

TRATOS General Cables®

H03V2V2-F / H05V2V2-F cable

TRATOS H03V2V2-F TRATOS H05V2V2-F

Reference Guide EN 50565

H03V2V2-F: For mobile use. Use in domestic premises, kitchens and offices, for light duty applications and appliances

H05V2V2-F: For mobile use. Use in domestic premises and offices, for ordinary duty applications and household appliances, including in damp premises. Use outdoor for temporary periods of short duration.

Both cables can be used at high ambient temperatures and inside equipments that present no risk of contact with hot components. Should the surface temperature of the cable exceed 50°C, it is important to avoid the contact with skin.

N.B. For applications not covered by Regulation EU 305/2011.

FEATURES AND PERFORMANCES

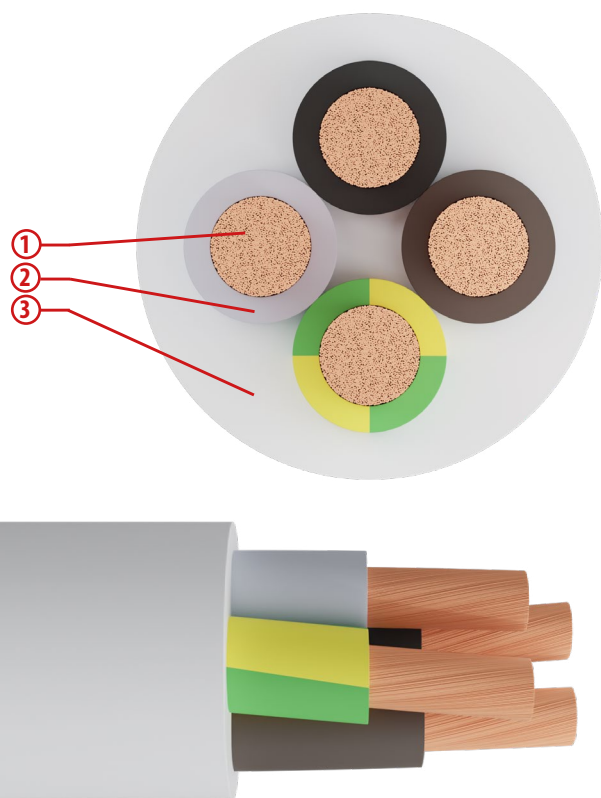

CONSTRUCTION

1. CLASS 5, FLEXIBLE, PLAIN COPPER WIRE
2. PVC SPECIAL 90°C, T13 QUALITY
3. PVC SPECIAL 90°C, TM3 QUALITY

Structure and electrical, physical, mechanical requirements: EN 50525-2-11

- Flame propagation EN 60332-1-2
- Low Voltage Directive 2014/35/EU
- RoHS Directive 2011/65/EU

Functional characteristics

Rated voltage H03V2V2-F: U _o /U	300/300 V
Rated voltage H05V2V2-F: U _o /U	300/500 V
Max. operating temperature	90°C
Min. operating temperature	-10°C (without mechanical shocks)
Max. short circuit temperature	150°C

H03V2V2-F / Installation conditions

Minimum installation temperature	5 °C
Recommended min. bending radius	6 times the cable diameter
Recommended maximum tensile stress	15 N/mm ² of the cross-section of the copper

H05V2V2-F / Installation conditions

Minimum installation temperature	5 °C
Recommended min. bending radius	6 times the cable diameter for mobile use, 4 times the cable diameter for static use
Recommended maximum tensile stress	15 N/mm ² of the cross-section of the copper for mobile use, 50 N/mm ² for static use

Cable Marking

Tratos IEMMEQU [HAR] H03V2V2-F

Tratos IEMMEQU [HAR] H05V2V2-F

Colours

- TWO-CORE
- THREE-CORE or
- FOUR-CORE or
- FIVE-CORE or

H03V2V2-F

Formation	Approx. conductor \emptyset	Average insulation thickness	Average sheath thickness	Approx. external \emptyset	Max. electrical resistance at 20°C	Approx. cable weight	Current rating in air at 30°C
$n^{\circ} \times \text{mm}^2$	mm	mm	mm	mm	Ω/km	kg/km	A
2 x 0,5	0,9	0,5	0,6	5,9	39,0	31	3
2 x 0,75	1,1	0,5	0,6	6,3	26,0	38	6
3G0,5	0,9	0,5	0,6	6,3	39,0	37	3
3G0,75	1,1	0,5	0,6	6,7	26,0	46	6
4G0,5	0,9	0,5	0,6	6,9	39,0	45	3
4G0,75	1,1	0,5	0,6	7,3	26,0	68	6

N.B. The values of current rating indicated apply in most cases

H05V2V2-F

Formation	Approx. conductor \emptyset	Average insulation thickness	Average sheath thickness	Approx. external \emptyset	Max. electrical resistance at 20°C	Approx. cable weight	Current rating in air at 30°C
$n^{\circ} \times \text{mm}^2$	mm	mm	mm	mm	Ω/km	kg/km	A
2 x 0,75	1,1	0,6	0,8	7,2	26,0	49	6
2 x 1	1,3	0,6	0,8	7,5	19,5	57	10
2 x 1,5	1,5	0,7	0,8	8,6	13,3	79	16
2 x 2,5	2,0	0,8	1,0	10,6	7,98	120	20
2 x 4	2,5	0,8	1,1	12,1	4,95	165	25
3G0,75	1,1	0,6	0,8	7,6	26,0	58	6
3G1	1,3	0,6	0,8	8,0	19,5	68	10
3G1,5	1,5	0,7	0,9	9,4	13,3	96	16
3G2,5	2,0	0,8	1,1	11,4	7,98	150	20
3G4	2,5	0,8	1,2	13,1	4,95	210	25
4G0,75	1,1	0,6	0,8	8,3	26,0	70	6
4G1	1,3	0,6	0,9	9,0	19,5	86	10
4G1,5	1,5	0,7	1,0	10,5	13,3	120	16
4G2,5	2,0	0,8	1,1	12,5	7,98	180	20
4G4	2,5	0,8	1,2	14,3	4,95	255	25
5G0,75	1,1	0,6	0,9	9,3	26,0	87	6
5G1	1,3	0,6	0,9	9,8	19,5	105	10
5G1,5	1,5	0,7	1,1	11,6	13,3	150	16
5G2,5	2,0	0,8	1,2	13,9	7,98	225	20
5G4	2,5	0,8	1,4	16,1	4,95	325	25

N.B. The values of current rating indicated apply in most cases

H03V2V2H2-F cable

TRATOS H03V2V2H2-F

Reference Guide EN 50565

Mobile laying: suitable for domestic premises, kitchens, and offices, in settings with high temperatures and subject to light mechanical loads. Suitable for cooking, heating and lighting appliances provided that cables do not get in contact with hot parts and are not subject to radiations. Avoid skin contact if operating at high temperatures. Not allowed for outside use.

Reference Construction Products Regulation 305/2011 EU and Standard EN 50575:

The cable is suitable for the supply of electricity in buildings and other civil engineering works.

FEATURES AND PERFORMANCES

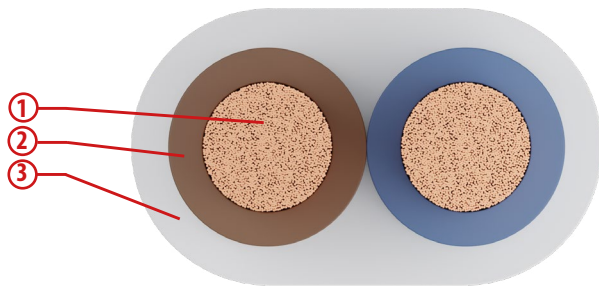

CONSTRUCTION

1. CLASS 5, FLEXIBLE, PLAIN COPPER WIRE
2. PVC SPECIAL 90°C, T13 QUALITY
3. PVC SPECIAL 90°C, TM3 QUALITY, FLAT SHAPE

Structure and electrical, physical, mechanical requirements: EN 50525-2-11

- Low Voltage Directive 2014/35/EU
- RoHS Directive 2011/65/EU

Cable Marking

Tratos IEMMEQU[HAR] H03V2V2H2-F

Colours

TWO-CORE ● ●

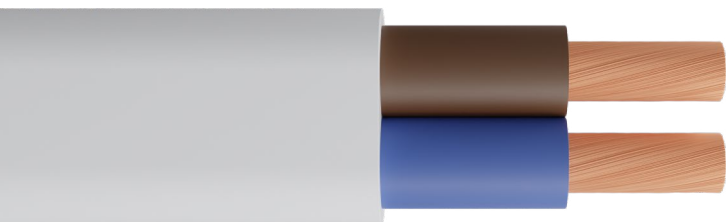

Functional characteristics

Rated voltage: U ₀ /U	300/300 V
Max. operating temperature	90°C
Min. operating temperature	-10°C (without mechanical shocks)
Max. short circuit temperature	150°C

Installation conditions

Minimum installation temperature	5°C
Recommended min. bending radius	6 times the cable diameter
Recommended maximum tensile stress	15 N/mm ² of the cross-section of the copper for mobile use, 50 N/mm ² for static use

Formation	Approx. conductor Ø	Average insulation thickness	Average sheath thickness	Max. external Ø	Max. electrical resistance at 20°C	Approx. cable weight	Current rating in pipe in air at 30°C
n° x mm ²	mm	mm	mm	mm	Ω/km	kg/km	A
2 x 0,5	0,9	0,5	0,6	3,7 x 5,9	39,0	27	3
2 x 0,75	1,1	0,5	0,6	3,8 x 6,3	26,0	32	6

H05V2V2H2-F cable

TRATOS H05V2V2H2-F

Reference Guide EN 50565

Mobile laying: suitable for domestic premises, kitchens, and offices, in settings with high temperatures and subject to moderate mechanical load. Suitable for cooking, heating and lighting appliances provided that cables do not get in contact with hot parts and are not subject to radiations. Not allowed for outside use, in industrial and agricultural buildings and for non-domestic portable tools. Avoid skin contact if operating at high temperatures. For temporary external use only.

N.B. For applications not covered by Regulation EU 305/2011.

FEATURES AND PERFORMANCES

CONSTRUCTION

1. CLASS 5, FLEXIBLE, PLAIN COPPER WIRE
2. PVC SPECIAL 90°C, T13 QUALITY
3. PVC SPECIAL 90°C, TM3 QUALITY, FLAT SHAPE

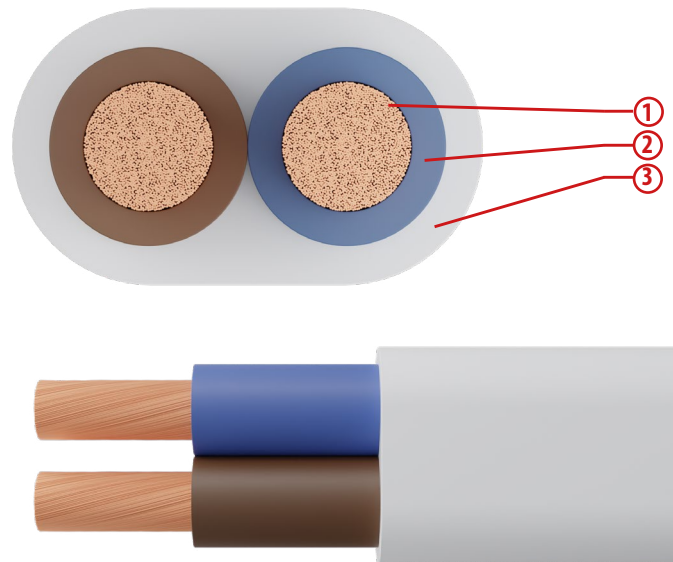

Structure and electrical, physical, mechanical requirements: EN 50525-2-11

- **Flame propagation** EN 60332-1-2
- **Low Voltage Directive** 2014/35/EU
- **RoHS Directive** 2011/65/EU

Cable Marking

Tratos IEMMEQU [HAR] H05V2V2H2-F

Colours

TWO-CORE ● ●

Functional characteristics	
Rated voltage: U _o /U	300/300 V
Max. operating temperature	90°C
Min. operating temperature	-10°C (without mechanical shocks)
Max. short circuit temperature	150°C

Installation conditions	
Minimum installation temperature	5°C
Recommended min. bending radius	6 times of the smaller dimension of the cable for mobile use, 4 times the smaller dimension of the cable for static use.
Recommended maximum tensile stress	15 N/mm ² of the cross-section of the copper for mobile use, 50 N/mm ² for static use

Formation	Approx. conductor Ø	Average insulation thickness	Average sheath thickness	Max. external Ø	Max. electrical resistance at 20°C	Approx. cable weight	Current rating in pipe in air at 30°C
n° x mm ²	mm	mm	mm	mm	Ω/km	kg/km	A
2 x 0,75	1,1	0,6	0,8	4,5 x 7,2	26,0	40	6
2 x 1	1,3	0,6	0,8	4,7 x 7,5	19,5	50	10

H05VV5-F cable

TRATOS H05VV5-F

Reference Guide EN 50565

Mobile laying: suitable for interconnecting of parts of machines used for manufacturing purposes including machine tools. The cable may be allowed to move once installed, particularly for the reposition, maintenance, adjustment and inspection of machines, provided that the cable is not mechanically stressed during movement.

For applications requiring resistance to general purpose mineral oils.

Contamination by hydrocarbons, acids, and alkalis shall be avoided and the cables shall be protected against mechanical damage. Use inside buildings, where the cables are not required to move in use, installation in conduit, trunking etc. is advised. Use outdoor is allowed for temporary periods of short duration.

Reference Construction Products Regulation 305/2011 EU and Standard EN 50575:

The cable is suitable for the supply of electricity in buildings and other civil engineering works.

FEATURES AND PERFORMANCES

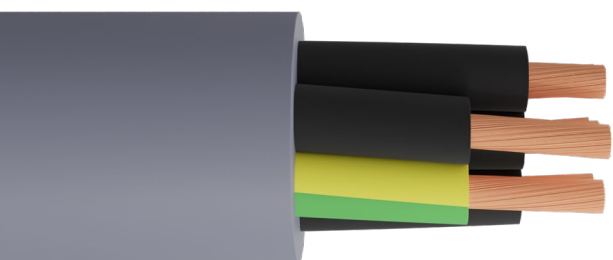
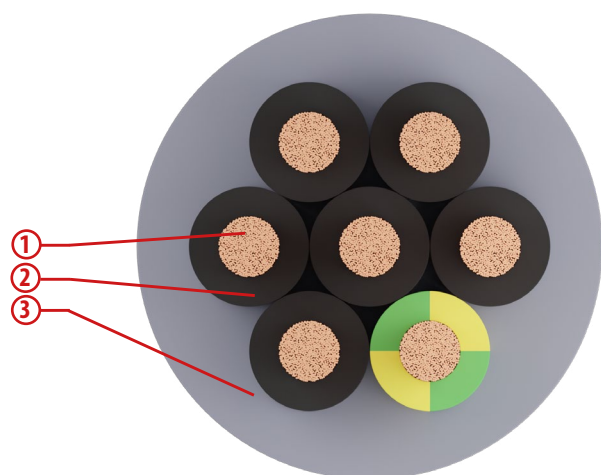

CONSTRUCTION

1. CLASS 5, FLEXIBLE, PLAIN COPPER WIRE
2. PVC, TI2 QUALITY
3. SPECIAL PVC, TM5 QUALITY, OIL RESISTANCE

Structure and electrical, physical, mechanical requirements: EN 50525-2-51

- Low Voltage Directive 2014/35/EU
- RoHS Directive 2011/65/EU

Special features

Good flexibility and resistance to industrial lubricants.

Cable Marking

Tratos H05VV5-F [form.] IEMMEQU [HAR] RoHS CE [y/ww]

Colours

- TWO-CORE
- THREE-CORE
- FOUR-CORE
- FIVE-CORE
- MULTI-CORE (>5 cores)

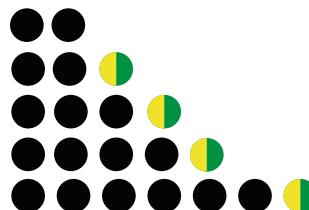

Installation conditions

Minimum installation temperature	5 °C
Recommended min. bending radius	6 times the cable diameter for mobile use, 4 times the cable diameter for static use
Recommended maximum tensile stress	15 N/mm ² of the cross-section of the copper for mobile use, 50 N/mm ² for static use

Functional characteristics

Rated voltage H05V2V2-F: U _o /U	300/500 V
Max. operating temperature	60°C
Min. operating temperature	-10°C (without mechanical shocks)
Max. short circuit temperature	150°C

H05VV5-F

Formation	Approx. conductor \emptyset	Average insulation thickness	Average sheath thickness	Max. external \emptyset	Max. electrical resistance at 20°C	Approx. cable weight
n° x mm ²	mm	mm	mm	mm	Ω /km	kg/km
2 x 1	1,3	0,6	0,8	7,5	19,5	56
2 x 1,5	1,5	0,7	0,8	8,6	13,3	76
2 x 2,5	2,0	0,8	0,9	10,3	7,98	120
3G0,75	1,1	0,6	0,8	7,6	26,0	58
3G1	1,3	0,6	0,8	8,0	19,5	68
3G1,5	1,5	0,7	0,9	9,4	13,3	96
3G2,5	2,0	0,8	1,0	11,2	7,98	150
4G0,5	0,9	0,6	0,8	7,9	39,0	56
4G0,75	1,1	0,6	0,8	8,3	26,0	71
4G1	1,3	0,6	0,8	8,7	19,5	83
4G1,5	1,5	0,7	0,9	10,2	13,3	120
4G2,5	2,0	0,8	1,1	12,5	7,98	185
5G0,5	0,9	0,6	0,8	8,6	39,0	69
5G0,75	1,1	0,6	0,9	9,3	26,0	89
5G1	1,3	0,6	0,9	9,8	19,5	105
5G1,5	1,5	0,7	1,0	11,4	13,3	150
5G2,5	2,0	0,8	1,1	13,7	7,98	230
7G0,5	0,9	0,6	0,9	10,4	39,0	100
7G0,75	1,1	0,6	1,0	11,3	26,0	130
7G1	1,3	0,6	1,0	11,8	19,5	150
7G1,5	1,5	0,7	1,2	14,1	13,3	220
7G2,5	2,0	0,8	1,3	16,8	7,98	335
12G0,5	0,9	0,6	1,1	12,9	39,0	155
12G0,75	1,1	0,6	1,1	13,7	26,0	190
12G1	1,3	0,6	1,2	14,6	19,5	230
12G1,5	1,5	0,7	1,3	17,0	13,3	320
12G2,5	2,0	0,8	1,5	20,6	7,98	496
18G0,5	0,9	0,6	1,2	15,3	39,0	225
18G0,75	1,1	0,6	1,3	16,4	26,0	280
18G1	1,3	0,6	1,3	17,2	19,5	335
18G1,5	1,5	0,7	1,5	20,3	13,3	475
18G2,5	2,0	0,8	1,8	24,8	7,98	740
27G0,5	0,9	0,6	1,4	18,6	39,0	325
27G0,75	1,1	0,6	1,5	19,9	26,0	401
27G1	1,3	0,6	1,5	21,0	19,5	480
27G1,5	1,5	0,7	1,8	24,9	13,3	695
27G2,5	2,0	0,8	2,1	30,2	7,98	1080

H05VVC4V5-K cable

TRATOS H05VVC4V5-K

Reference Guide EN 50565

Suitable for interconnecting of parts of machines used for manufacturing purposes including machine tools where some degree of protection against electromagnetic interference is required. The cable may be allowed to move once installed, particularly for the reposition, maintenance, adjustment and inspection of machines, provided that the cable is not mechanically stressed during movement, it's not suitable to continuous bending.

For applications requiring resistance to general purpose mineral oils. Contamination by hydrocarbons, acids, and alkalis shall be avoided and the cables shall be protected against mechanical damage.

Use inside buildings, where the cables are not required to move in use, installation in conduit, trunking etc. is advised. Use outdoor is allowed for temporary periods of short duration.

Reference Construction Products Regulation 305/2011 EU and Standard EN 50575:

The cable is suitable for the supply of electricity in buildings and other civil engineering works.

FEATURES AND PERFORMANCES

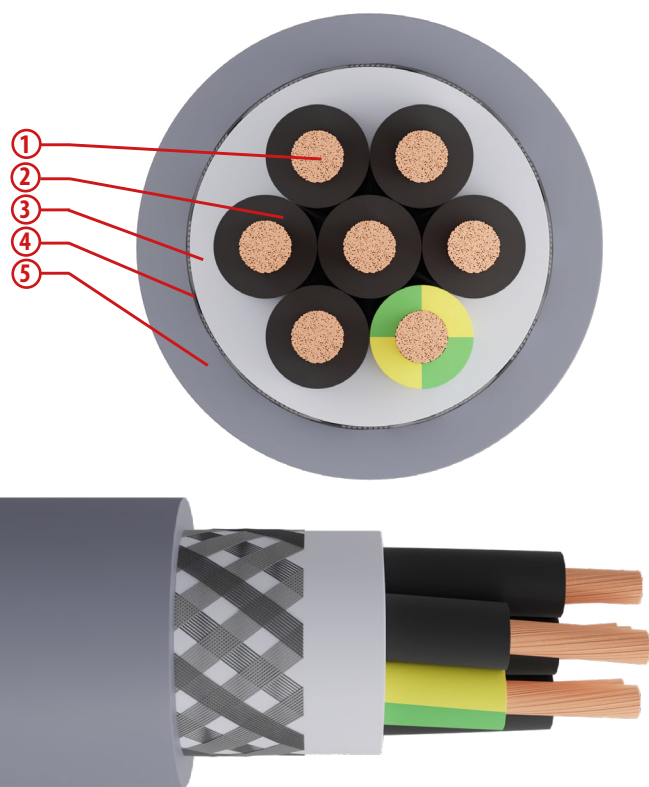

CONSTRUCTION

1. CLASS 5, FLEXIBLE, PLAIN COPPER WIRE
2. PVC, TI2 QUALITY
3. PVC, WITH THE FUNCTION OF CENTRAL FILLER (OPTIONAL)
4. PVC, TM2 QUALITY
5. TINNED COPPER BRAID
6. SPECIAL PVC, TM5 QUALITY, OIL RESISTANCE

Structure and electrical, physical, mechanical requirements: EN 50525-2-51

- Low Voltage Directive 2014/35/EU
- RoHS Directive 2011/65/EU

Special features

Good resistance to industrial lubricants.

Cable Marking

Tratos H05VVC4V5-K [form.] IEMMEQU [HAR] RoHS CE [y/ww]

Colours

- TWO-CORE
- THREE-CORE
- FOUR-CORE
- FIVE-CORE
- MULTI-CORE (>5 cores)

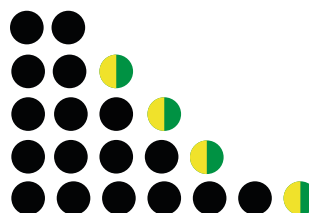

Installation conditions	
Minimum installation temperature	5 °C
Recommended min. bending radius	8 times the cable diameter
Recommended maximum tensile stress	50 N/mm ² of the cross-section of the copper

Functional characteristics	
Rated voltage H05V2V2-F: U ₀ /U	300/500 V
Max. operating temperature	60°C
Min. operating temperature	-10°C (without mechanical shocks)
Max. short circuit temperature	150°C

H05VVC4V5-K

Formation	Approx. conductor \emptyset	Average insulation thickness	Average sheath thickness	Max. external \emptyset	Max. electrical resistance at 20°C	Approx. cable weight
n° x mm ²	mm	mm	mm	mm	Ω /km	kg/km
3 x 2,5	1,3	0,8	1,1	14,0	7,98	210
4 x 1,5	1,5	0,7	1,1	13,2	13,3	185
4 x 2,5	2,0	0,8	1,2	15,5	7,98	270
5G1	1,3	0,6	1,1	12,8	19,5	170
5G1,5	1,5	0,7	1,2	14,7	13,3	225
5G2,5	2,0	0,8	1,3	17,2	7,98	330
6 x 1	1,3	0,7	1,1	10,8	19,5	195
7G0,5	0,9	0,6	1,1	13,5	39,0	170
7G0,75	1,1	0,6	1,2	14,3	26,0	200
7G1	1,3	0,6	1,2	15,1	19,5	240
7G1,5	1,5	0,7	1,3	17,4	13,3	320
7G2,5	2,0	0,8	1,5	20,3	7,98	470
12G0,5	0,9	0,6	1,3	16,5	39,0	255
12G0,75	1,1	0,6	1,3	17,2	26,0	290
12G1	1,3	0,6	1,4	18,1	19,5	340
12G1,5	1,5	0,7	1,5	20,5	13,3	460
12G2,5	2,0	0,8	1,7	24,4	7,98	670
18G0,5	0,9	0,6	1,3	18,6	39,0	350
18G0,75	1,1	0,6	1,5	19,9	26,0	410
18G1	1,3	0,6	1,5	20,8	19,5	470
18G1,5	1,5	0,7	1,7	24,1	13,3	640
18G2,5	2,0	0,8	2,0	28,5	7,98	950
27G0,5	0,9	0,6	1,6	22,1	39,0	480
27G0,75	1,1	0,6	1,7	23,7	26,0	570
27G1	1,3	0,6	1,7	24,7	19,5	655
27G1,5	1,5	0,7	2,0	28,6	13,3	905
27G2,5	2,0	0,8	2,3	34,5	7,98	1380
36G0,5	0,9	0,6	1,7	24,7	39,0	610
36G0,75	1,1	0,6	1,8	26,2	26,0	715
36G1	1,3	0,6	1,9	27,6	19,5	840

H05RR-F cable

TRATOS H05RR-F

Reference Guide EN 50565

For mobile use. Use in domestic premises, kitchens and offices, for ordinary duty applications and supplying appliances where cables are subject to low mechanical stresses (ex. vacuum cleaners, cooking appliances, soldering irons, toasters, domestic portable tools, hand held inspection lamps). Use outdoor for temporary periods of short duration.

Reference Construction Products Regulation 305/2011 EU and Standard EN 50575:

The cable is suitable for the supply of electricity in buildings and other civil engineering works.

FEATURES AND PERFORMANCES

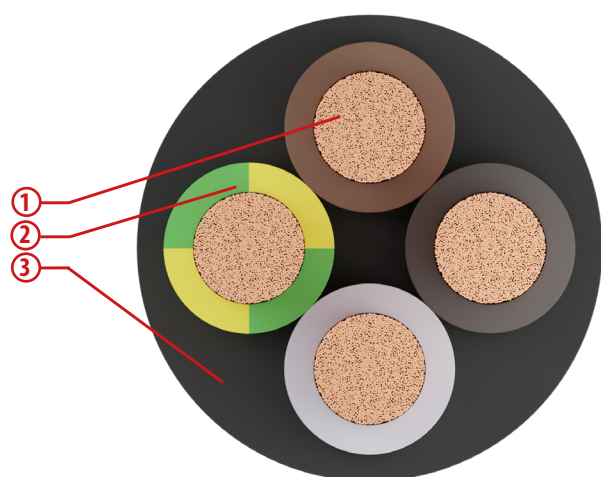

CONSTRUCTION

1. CLASS 5, FLEXIBLE, PLAIN COPPER WIRE
2. RUBBER COMPOUND, EI4 QUALITY
3. RUBBER COMPOUND, EI4 QUALITY

Structure and electrical, physical, mechanical requirements: EN 50525-2-51



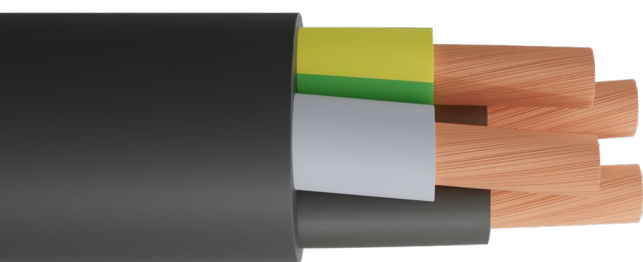



- Low Voltage Directive 2014/35/EU
- RoHS Directive 2011/65/EU



Cable Marking

Tratos LTC IEMMEQU [HAR] H05RR-F [form.] [traceability] [year]
Made in Italy [metric]

Colours

- TWO-CORE 
- THREE-CORE  or 
- FOUR-CORE  or 
- FIVE-CORE  or 

Installation conditions

Minimum installation temperature	-25 °C
Recommended min. bending radius	6 times of the cable diameter for mobile use, 4 times for static use
Recommended maximum tensile stress	15 N/mm ² of the cross-section of the copper for mobile use, 50 N/mm ² for static use

Functional characteristics

Rated voltage H05V2V2-F: U ₀ /U	300/500 V
Max. operating temperature	60°C
Min. operating temperature	-40°C (without mechanical shocks)
Max. short circuit temperature	200°C

H05RR-F

Formation	Approx. conductor \emptyset	Average insulation thickness	Average sheath thickness	Max. external \emptyset	Max. electrical resistance at 20°C	Approx. cable weight	Current rating in air at 30°C
n° x mm ²	mm	mm	mm	mm	Ω /km	kg/km	A
2 x 1	1,3	0,6	0,9	8,0	19,5	71	10
2 x 1,5	1,5	0,8	1,0	9,8	13,3	98	16
2 x 2,5	2,0	0,9	1,1	11,6	7,98	140	20
3G0,75	1,1	0,6	0,9	8,1	26,0	76	6
3G1	1,3	0,6	0,9	8,5	19,5	87	10
3G1,5	1,5	0,8	1,0	10,4	13,3	120	16
3G2,5	2,0	0,9	1,1	12,4	7,98	170	20
3G4	2,5	1,0	1,2	14,5	4,95	230	25
3G6	3,0	1,0	1,4	16,3	3,30	320	30
4G0,75	1,1	0,6	0,9	8,8	26,0	87	6
4G1	1,3	0,6	0,9	9,3	19,5	105	10
4G1,5	1,5	0,8	1,1	11,6	13,3	150	16
4G2,5	2,0	0,9	1,2	13,8	7,98	220	20
4G4	2,5	1,0	1,3	16,2	4,95	320	25
4G6	3,0	1,0	1,5	18,1	3,30	450	30
5G0,75	1,1	0,6	1,0	9,9	26,0	110	6
5G1	1,3	0,6	1,0	10,3	19,5	130	10
5G1,5	1,5	0,8	1,1	12,7	13,3	185	16

N.B. The values of current rating indicated apply in most cases

H05RN-F cable

TRATOS H05RN-F

Reference Guide EN 50565

For mobile use. Use in domestic premises, kitchens and offices, for ordinary duty applications and supplying appliances where cables are subject to low mechanical stresses (ex. vacuum cleaners, cooking appliances, soldering irons, toasters, domestic portable tools, hand held inspection lamps). Use outdoor is allowed.

Reference Construction Products Regulation 305/2011 EU and Standard EN 50575:

The cable is suitable for the supply of electricity in buildings and other civil engineering works.

FEATURES AND PERFORMANCES

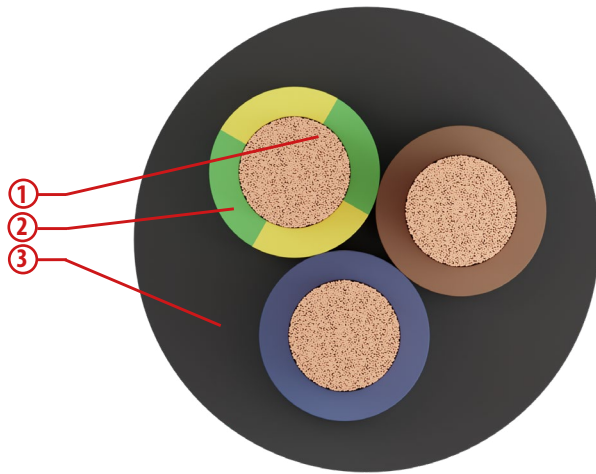

CONSTRUCTION

1. CLASS 5, FLEXIBLE, PLAIN COPPER WIRE
2. RUBBER COMPOUND, EI4 QUALITY
3. POLYCHLOROPRENE OR EQUIVALENT SYNTHETIC ELASTOMER, EM2 QUALITY

Structure and electrical, physical, mechanical requirements: EN 50525-2-51

- Low Voltage Directive 2014/35/EU
- RoHS Directive 2011/65/EU

Cable Marking

Tratos LTC IEMMEQU [HAR] H05RN-F [form.] [traceability] [year]
Made in Italy [metric]

Colours

- TWO-CORE
- THREE-CORE
- FOUR-CORE
- FIVE-CORE

Installation conditions

Minimum installation temperature	-25 °C
Recommended min. bending radius	6 times of the cable diameter for mobile use, 4 times for static use
Recommended maximum tensile stress	15 N/mm ² of the cross-section of the copper for mobile use, 50 N/mm ² for static use

Functional characteristics

Rated voltage: U _o /U	300/500 V
Max. operating temperature	60°C
Min. operating temperature	-40°C (without mechanical shocks)
Max. short circuit temperature	200°C

H05RN-F

Formation	Approx. conductor \emptyset	Average insulation thickness	Average sheath thickness	Max. external \emptyset	Max. electrical resistance at 20°C	Approx. cable weight	Current rating in air at 30°C
$n^{\circ} \times \text{mm}^2$	mm	mm	mm	mm	Ω/km	kg/km	A
2 x 0,75	1,1	0,6	0,8	7,4	26,0	60	6
2 x 1	1,3	0,6	0,9	8,0	19,5	73	10
3 x 0,75	1,1	0,6	0,9	8,1	26,0	79	6
3 x 1	1,3	0,6	0,9	8,5	19,5	87	10
4 x 0,75	1,1	0,6	0,9	8,8	26,0	89	6
5 x 0,75 *	1,3	0,6	1,0	9,9	26,0	110	10

* FORMATION WITHOUT CERTIFICATION [HAR]

N.B. The values of current rating indicated apply in most cases

H07RN-F cable

TRATOS H07RN-F

Reference Guide EN 50565:

For mobile laying: indoor use, outdoor use and in industrial and agricultural workshops.

For supplying industrial and agricultural machines and appliances subject to medium mechanical stresses (e.g. heating plates, inspection lamps, electric tools such as drills, circular saws and domestic electric tools).

For fixed laying: it can be used in temporary buildings or huts in building sites. Suitable for connections of constructive elements of lifting appliances and machines. Suitable for use in dry, humid or moist rooms (AD6). If used in protected installations such as tubes or similar closed systems, voltages up to 1000V in a.c. or 750V in d.c. to ground are allowed.

Reference Construction Products Regulation 305/2011 EU and Standard EN 50575:

The cable is suitable for the supply of electricity in buildings and other civil engineering works.

FEATURES AND PERFORMANCES

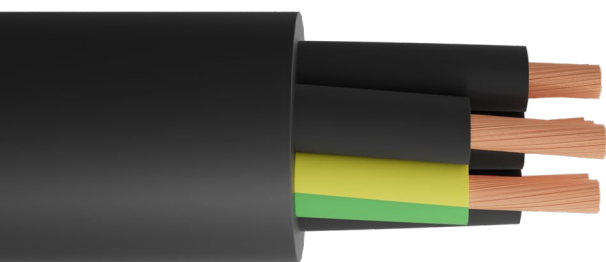
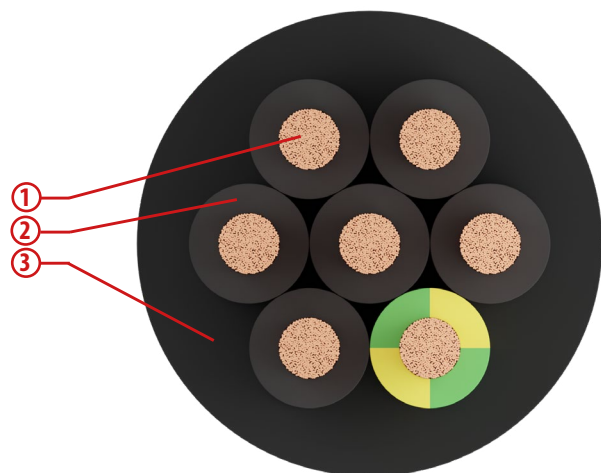

CONSTRUCTION

1. CLASS 5, FLEXIBLE, PLAIN COPPER WIRE
2. RUBBER COMPOUND, EI4 QUALITY
3. POLYCHLOROPRENE OR EQUIVALENT SYNTHETIC ELASTOMER, WATER RESISTENCE (AD6)

Structure and electrical, physical, mechanical requirements: EN 50525-2-51

- Low Voltage Directive 2014/35/EU
- RoHS Directive 2011/65/EU

Special features

Good flexibility and mechanical resistance to abrasion, shocks, crushing and lacerations.
Good resistance to atmospheric agents, grease and mineral oils.
UV-resistant.

Cable Marking

Tratos LTC IEMMEQU [HAR] H05RN-F [form.] [traceability] [year]
Made in Italy [metric]

Colours

SINGLE-CORE	●
TWO-CORE	● ●
THREE-CORE	● ● ● or ● ● ●
FOUR-CORE	● ● ● ● or ● ● ● ●
FIVE-CORE	● ● ● ● ● or ● ● ● ● ●

Installation conditions

Minimum installation temperature	-25 °C
Recommended min. bending radius	6 times of the cable diameter for mobile use, 4 times for static use
Recommended maximum tensile stress	15 N/mm ² of the cross-section of the copper for mobile use, 50 N/mm ² for static use

Functional characteristics

Rated voltage: U _o /U	450/750 V a.c. (for fixed and protected installation 0,6/1 kV a.c.)
Max. operating temperature	60°C (*)
Min. operating temperature	-40°C (without mechanical shocks)
Max. short circuit temperature	200°C

(*) In the case of fixed protected installation, the cable can be used up to 85°C.

Single-core

Formation	Approx. conductor \emptyset	Average insulation thickness	Average sheath thickness	Max. external \emptyset	Max. electrical resistance at 20°C	Approx. cable weight	Mobile installation in open air, ambient temperature 30°C	Fixed and protected installation in open air, ambient temperature 30°C	Voltage drop
n° x mm ²	mm	mm	mm	mm	Ω /km	kg/km	A	A	V/A-Km
1 x 1,5	1,5	0,8	1,4	7,1	13,3	50	16	23	26,5
1 x 2,5	2,0	0,9	1,4	7,9	7,98	65	20	31	16,0
1 x 4	2,5	1,0	1,5	9,0	4,95	89	30	43	9,93
1 x 6	3,0	1,0	1,6	9,8	3,30	120	38	55	6,63
1 x 10	4,0	1,2	1,8	11,9	1,91	180	53	76	3,87
1 x 16	5,0	1,2	1,9	13,4	1,21	250	71	102	2,47
1 x 25	6,2	1,4	2,0	15,8	0,780	350	94	129	1,61
1 x 35	7,4	1,4	2,2	17,9	0,554	470	117	161	1,17
1 x 50	8,9	1,6	2,4	20,6	0,386	650	148	198	0,844
1 x 70	10,5	1,6	2,6	23,3	0,272	870	185	256	0,609
1 x 95	12,2	1,8	2,8	26,0	0,206	1120	222	314	0,484
1 x 120	13,8	1,8	3,0	28,6	0,161	1400	260	366	0,388
1 x 150	15,4	2,0	3,2	31,4	0,129	1425	300	425	0,325
1 x 185	16,9	2,2	3,4	34,4	0,106	2090	341	488	0,279
1 x 240	19,5	2,4	3,5	38,3	0,0801	2660	407	581	0,221
1 x 300	21,6	2,6	3,6	41,9	0,0641	3280	468	673	0,184
1 x 400	24,8	2,8	3,8	46,8	0,0486	4230	553	787	0,159
1 x 500	28,5	3,0	4,0	52,0	0,0384	5230	620	905	0,137
1 x 630	32,8	3,0	4,1	57,0	0,0287	6780	742	1041	0,122

N.B. Permissible current rating values are according to:
- three-phase circuit

Two-core

Formation	Approx. conductor \emptyset	Average insulation thickness	Average sheath thickness	Max. external \emptyset	Max. electrical resistance at 20°C	Approx. cable weight	Mobile installation in open air, ambient temperature 30°C	Fixed and protected installation in open air, ambient temperature 30°C	Voltage drop
n° x mm ²	mm	mm	mm	mm	Ω /km	kg/km	A	A	V/A-Km
2 x 1	1,3	0,8	1,3	10,0	19,5	97	10	18	45,2
2 x 1,5	1,5	0,8	1,5	11,0	13,3	120	18	23	30,6
2 x 2,5	2,0	0,9	1,7	13,1	7,98	170	27	32	18,4
2 x 4	2,5	1,0	1,8	15,1	4,95	230	34	43	11,4
2 x 6	3,0	1,0	2,0	16,8	3,30	300	43	56	7,63
2 x 10	4,0	1,2	3,1	22,6	1,91	520	60	77	4,44
2 x 16	5,0	1,2	3,3	25,7	1,21	720	79	102	2,84
2 x 25	6,2	1,4	3,6	30,7	0,780	1030	105	136	1,85
2 x 35	7,3	1,4	3,7	34,3	0,554	1290	129	168	1,34

N.B. Permissible current rating values are according to:
- two-phase circuit for two-core cables

TRATOS General Cables®

Three-core

Formation	Approx. conductor Ø	Average insulation thickness	Average sheath thickness	Max. external Ø	Max. electrical resistance at 20°C	Approx. cable weight	Mobile installation in open air, ambient temperature 30 °C	Fixed and protected installation in open air, ambient temperature 30°C	Voltage drop
n° x mm ²	mm	mm	mm	mm	Ω/km	kg/km	A	A	V/A-Km
3G1	1,3	0,8	1,4	10,7	19,5	120	10	18	45,2
3G1,5	1,5	0,8	1,6	11,9	13,3	145	16	23	30,6
3G2,5	2,0	0,9	1,8	14,0	7,98	205	25	32	18,4
3G4	2,5	1,0	1,9	16,2	4,95	280	29	43	11,4
3G6	3,0	1,0	2,1	18,0	3,30	375	36	56	7,63
3G10	4,0	1,2	3,3	24,2	1,91	645	51	77	4,44
3G16	5,0	1,2	3,5	27,6	1,21	890	67	102	2,84
3G25	6,2	1,4	3,8	33,0	0,780	1280	89	136	1,85
3G35	7,4	1,4	4,1	37,1	0,554	1660	110	168	1,34
3G50	8,9	1,6	4,5	42,9	0,386	2300	138	203	0,962
3G70	10,5	1,6	4,8	48,3	0,272	3060	172	254	0,691
3G95	12,2	1,8	5,3	54,0	0,206	3945	204	299	0,546
3G120	13,8	1,8	5,6	60,0	0,161	4905	238	363	0,438
3G150	15,4	2,0	6,0	66,0	0,129	6060	273	416	0,366
3G185	16,9	2,2	6,4	72,0	0,106	7330	309	475	0,220
3G240	19,5	2,4	7,1	82,0	0,0801	9500	365	559	0,210
3G300	21,6	2,6	7,7	90,0	0,0641	11750	450	637	0,180

(*) also available without the green/yellow
 N.B. Permissible current rating values are according to:
 - three-phase circuit for three-core cables

Four-core

Formation	Approx. conductor Ø	Average insulation thickness	Average sheath thickness	Max. external Ø	Max. electrical resistance at 20°C	Approx. cable weight	Mobile installation in open air, ambient temperature 30 °C	Fixed and protected installation in open air, ambient temperature 30°C	Voltage drop
n° x mm ²	mm	mm	mm	mm	Ω/km	kg/km	A	A	V/A-Km
4G1	1,3	0,8	1,5	11,9	19,5	145	10	16	39,0
4G1,5	1,5	0,8	1,7	13,1	13,3	175	16	21	26,5
4G2,5	2,0	0,9	1,9	15,5	7,98	250	20	29	16,0
4G4	2,5	1,0	2,0	17,9	4,95	345	30	38	9,93
4G6	3,0	1,0	2,3	20,0	3,30	465	37	50	6,63
4G10	4,0	1,2	3,4	26,5	1,91	790	52	68	3,87
4G16	5,0	1,2	3,6	30,1	1,21	1100	69	92	2,47
4G25	6,2	1,4	4,1	36,6	0,780	1610	92	122	1,61
4G35	7,4	1,4	4,4	41,1	0,554	2090	114	150	1,17
4G50	8,9	1,6	4,8	47,5	0,386	2900	143	182	0,844
4G70	10,5	1,6	5,2	54,0	0,272	3880	178	232	0,609
4G95	12,2	1,8	5,9	61,0	0,206	5050	210	281	0,484
4G120	13,8	1,8	6,0	66,0	0,161	6230	246	325	0,388
4G150	15,4	2,0	6,5	73,0	0,129	7720	282	373	0,325
4G185	16,9	2,2	4,2	80,0	0,106	9360	319	425	0,280

(*) also available without the green/yellow
 N.B. Permissible current rating values are according to:
 - three-phase circuit

Five-core

Formation	Approx. conductor \emptyset	Average insulation thickness	Average sheath thickness	Max. external \emptyset	Max. electrical resistance at 20°C	Approx. cable weight	Mobile installation in open air, ambient temperature 30 °C	Fixed and protected installation in open air, ambient temperature 30°C	Voltage drop
n° x mm ²	mm	mm	mm	mm	Ω /km	kg/km	A	A	V/A·Km
5G1	1,3	0,8	1,6	13,1	19,5	175	10	16	39
5G1,5	1,5	0,8	1,8	14,4	13,3	210	16	21	26,5
5G2,5	2,0	0,9	2,0	17,0	7,98	305	20	29	16,0
5G4	2,5	1,0	2,2	19,9	4,95	420	30	38	9,93
5G6	3,0	1,0	2,5	22,2	3,30	575	38	50	6,63
5G10	4,0	1,2	3,6	29,1	1,91	960	54	68	3,87
5G16	5,0	1,2	3,9	33,3	1,21	1350	71	92	2,47
5G25	6,2	1,4	4,4	40,4	0,780	1955	94	122	1,61
5G35	7,4	1,4	4,6	45,1	0,554	2520	114	150	1,17
5G50	8,9	1,6	5,2	53	0,386	3530	143	182	0,844
5G70	10,5	1,6	5,7	60	0,272	4760	178	232	0,609
5G95	12,2	1,8	6,3	67	0,206	6160	210	281	0,484

(*) also available without the green/yellow

N.B. Permissible current rating values are according to:
- three-phase circuit

Multi-core / signalling and control

Formation	Approx. conductor \emptyset	Average insulation thickness	Average sheath thickness	Max. external \emptyset	Max. electrical resistance at 20°C	Approx. cable weight	Mobile installation in open air, ambient temperature 30 °C	Fixed and protected installation in open air, ambient temperature 30°C	Voltage drop
n° x mm ²	mm	mm	mm	mm	Ω /km	kg/km	A	A	V/A·Km
7G1,5	1,5	0,8	2,5	17,2	13,3	335	11	16	30,7
12G1,5	1,5	0,8	2,9	22,4	13,3	500	9	14	30,7
19G1,5	1,5	0,8	3,2	26,3	13,3	720	8	13	30,7
24G1,5	1,5	0,8	3,5	30,7	13,3	915	7	12	30,7
36G1,5	1,5	0,8	3,8	35,2	13,3	1305	5	10	30,7
7G2,5	2,0	0,9	2,7	20,0	7,98	470	15	19	18,4
12G2,5	2,0	0,9	3,1	26,2	7,98	705	12	16	18,4
19G2,5	2,0	0,9	3,5	30,9	7,98	1030	10	14	18,4
24G2,5	2,0	0,9	3,9	36,4	7,98	1320	9	13	18,4
27G2,5	2,0	0,9	4,0	37,1	7,98	1450	7	11	18,4
36G2,5	2,0	0,9	4,3	41,8	7,98	1880	7	11	18,4

(*) also available without the green/yellow

N.B. Permissible current rating values are according to:
- all conductors are charged (except for the green/yellow).

H07RN8-F cable

TRATOS H07RN8-F

Reference Guide EN 50565:

Mobile laying: particularly suitable for connecting submerged pumps and cases in which the cable is permanently under water. For use indoor, outdoor, and in workshops with explosive atmospheres. Suitable for connections subject to moderate mechanical loads including electrical tools, machine tools (only for signalling and control), motors, or portable machines on building sites, or agricultural applications. For fixed installation can be used in temporary buildings or work site sheds. Suitable for connecting the constructional elements of lifting devices and machines. Up to 1000 V alternating or direct current in static, protected installations inside pipes or equipment and for connecting the motors of lifting equipment.

N.B. For applications not covered by Regulation EU 305/2011.

FEATURES AND PERFORMANCES

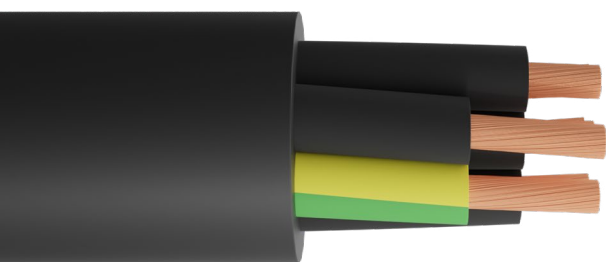
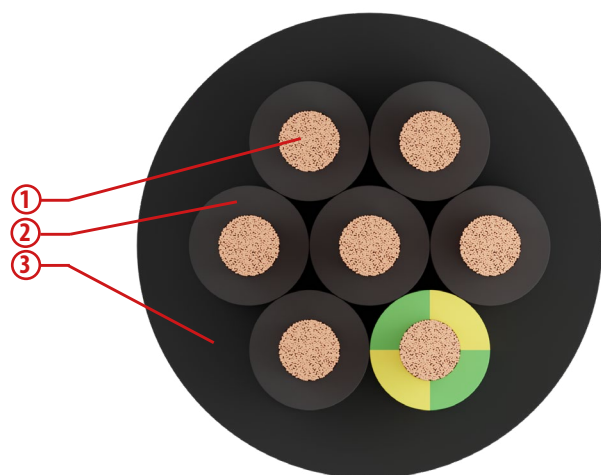

CONSTRUCTION

1. CLASS 5, FLEXIBLE, PLAIN COPPER WIRE
2. RUBBER COMPOUND, EI4 QUALITY
3. POLYCHLOROPRENE OR EQUIVALENT SYNTHETIC ELASTOMER, WATER RESISTENCE (AD8)

Structure and electrical, physical, mechanical requirements: EN 50525-2-51

- Flame propagation EN 60332-1-2
- Low Voltage Directive 2014/35/EU
- RoHS Directive 2011/65/EU

Special features

Good flexibility and mechanical resistance to abrasion, shocks, crushing and lacerations. Good resistance to atmospheric agents, grease and mineral oils. Water resistant for permanent immersions, class AD8 up to 10 m.

Cable Marking

Tratos LTC IEMMEQU [HAR] H07RN8-F [form.] [order number] [year]

Colours

- SINGLE-CORE ●
- TWO-CORE ● ●
- THREE-CORE ● ● ● or ● ● ●
- FOUR-CORE ● ● ● ● or ● ● ● ●
- FIVE-CORE ● ● ● ● ● or ● ● ● ● ●

The cores in multiple cables for signal and control are black, numbered, with or without GREEN/YELLOW

Installation conditions

Minimum installation temperature	-25 °C
Recommended min. bending radius	6 times of the cable diameter for mobile use, 4 times for static use
Recommended maximum tensile stress	15 N/mm ² of the cross-section of the copper for mobile use, 50 N/mm ² for static use

Functional characteristics

Rated voltage: U ₀ /U	450/750 V a.c. (600/1000 V d.c.)
Max. operating temperature	60°C (*)
Min. operating temperature	-40°C (without mechanical shocks)
Max. short circuit temperature	200°C

(*) In the case of fixed protected installation, the cable can be used up to 85°C.

Single-core

Formation	Approx. conductor \emptyset	Average insulation thickness	Average sheath thickness	Max. external \emptyset	Max. electrical resistance at 20°C	Approx. cable weight
n° x mm ²	mm	mm	mm	mm	Ω /km	kg/km
1 x 1,5	1,5	0,8	1,4	7,1	13,3	50
1 x 2,5	2,0	0,9	1,4	7,9	7,98	66
1 x 4	2,5	1,0	1,5	9,0	4,95	93
1 x 6	3,0	1,0	1,6	9,8	3,30	120
1 x 10	4,0	1,2	1,8	11,9	1,91	180
1 x 16	5,0	1,2	1,9	13,4	1,21	250
1 x 25	6,2	1,4	2,0	15,8	0,780	360
1 x 35	7,4	1,4	2,2	17,9	0,554	480
1 x 50	8,9	1,6	2,4	20,6	0,386	660
1 x 70	10,5	1,6	2,6	23,3	0,272	890
1 x 95	12,2	1,8	2,8	26,0	0,206	1150
1 x 120	13,8	1,8	3,0	28,6	0,161	1435
1 x 150	15,4	2,0	3,2	31,4	0,129	1775
1 x 185	16,9	2,2	3,4	34,4	0,106	2135
1 x 240	19,5	2,4	3,5	38,3	0,0801	2750

N.B. For current rating refer to table "Current carryings. Correction factors. Voltage drops"

Two-core

Formation	Approx. conductor \emptyset	Average insulation thickness	Average sheath thickness	Max. external \emptyset	Max. electrical resistance at 20°C	Approx. cable weight
n° x mm ²	mm	mm	mm	mm	Ω /km	kg/km
2 x 1	1,3	0,8	1,3	10,0	19,5	93
2 x 1,5	1,5	0,8	1,5	11,0	13,3	115
2 x 2,5	2,0	0,9	1,7	13,1	7,98	165
2 x 4	2,5	1,0	1,8	15,1	4,95	230
2 x 6	3,0	1,0	2,0	16,8	3,30	300
2 x 10	4,0	1,2	3,1	22,6	1,91	530
2 x 16	5,0	1,2	3,3	25,7	1,21	730
2 x 25	6,2	1,4	3,6	30,7	0,780	1035

N.B. For current rating refer to table "Current carryings. Correction factors. Voltage drops"

TRATOS General Cables®

Three-core

Formation	Approx. conductor \emptyset	Average insulation thickness	Average sheath thickness	Max. external \emptyset	Max. electrical resistance at 20°C	Approx. cable weight
n° x mm ²	mm	mm	mm	mm	Ω /km	kg/km
3 x 1	1,3	0,8	1,4	10,7	19,5	115
3 x 1,5	1,5	0,8	1,6	11,9	13,3	140
3 x 2,5	2,0	0,9	1,8	14,0	7,98	200
3 x 4	2,5	1,0	1,9	16,2	4,95	280
3 x 6	3,0	1,0	2,1	18,0	3,30	375
3 x 10	4,0	1,2	3,3	24,2	1,91	655
3 x 16	5,0	1,2	3,5	27,6	1,21	910
3 x 25	6,2	1,4	3,8	33,0	0,780	1300
3 x 35	7,4	1,4	4,1	37,1	0,554	1705
3 x 50	8,9	1,6	4,5	42,9	0,386	2350
3 x 70	10,5	1,6	4,8	48,3	0,272	3045
3 x 95	12,2	1,8	5,3	54,0	0,206	4035
3 x 120	13,8	1,8	5,6	60,0	0,161	5020
3 x 150	15,4	2,0	6,0	66,0	0,129	6210
3 x 185	16,9	2,2	6,4	72,0	0,106	7505

(*) also available with the green/yellow

N.B. For current rating refer to table "Current carryings. Correction factors. Voltage drops"

Four-core

Formation	Approx. conductor \emptyset	Average insulation thickness	Average sheath thickness	Max. external \emptyset	Max. electrical resistance at 20°C	Approx. cable weight
n° x mm ²	mm	mm	mm	mm	Ω /km	kg/km
4 x 1	1,3	0,8	1,5	11,9	19,5	140
4 x 1,5	1,5	0,8	1,7	13,1	13,3	170
4 x 2,5	2,0	0,9	1,9	15,5	7,98	250
4 x 4	2,5	1,0	2,0	17,9	4,95	350
4 x 6	3,0	1,0	2,3	20,0	3,30	470
4 x 10	4,0	1,2	3,4	26,5	1,91	800
4 x 16	5,0	1,2	3,6	30,1	1,21	1120
4 x 25	6,2	1,4	4,1	36,6	0,780	1645
4 x 35	7,4	1,4	4,4	41,1	0,554	2150
4 x 50	8,9	1,6	4,8	47,5	0,386	2965
4 x 70	10,5	1,6	5,2	54,0	0,272	3970
4 x 95	12,2	1,8	5,9	61,0	0,206	5165
4 x 120	13,8	1,8	6,0	66,0	0,161	6380
4 x 150	15,4	2,0	6,5	73,0	0,129	7910

(*) also available with the green/yellow

N.B. For current rating refer to table "Current carrying. Correction factors. Voltage drops"

Five-core

Formation	Approx. conductor \emptyset	Average insulation thickness	Average sheath thickness	Max. external \emptyset	Max. electrical resistance at 20°C	Approx. cable weight
n° x mm ²	mm	mm	mm	mm	Ω /km	kg/km
5 x 1	1,3	0,8	1,6	13,1	19,5	170
5 x 1,5	1,5	0,8	1,8	14,4	13,3	210
5 x 2,5	2,0	0,9	2,0	17,0	7,98	305
5 x 4	2,5	1,0	2,2	19,9	4,95	430
5 x 6	3,0	1,0	2,5	22,2	3,30	580
5 x 10	4,0	1,2	3,6	29,1	1,91	975
5 x 16	5,0	1,2	3,9	33,3	1,21	1375
5 x 25	6,2	1,4	4,4	40,4	0,780	2020

(*) also available with the green/yellow

N.B. For current rating refer to table "Current carryings. Correction factors. Voltage drops"

Multi-core / signalling and control

Formation	Approx. conductor \emptyset	Average insulation thickness	Average sheath thickness	Max. external \emptyset	Max. electrical resistance at 20°C	Approx. cable weight
n° x mm ²	mm	mm	mm	mm	Ω /km	kg/km
7 x 1,5	1,5	0,8	2,5	17,2	13,3	340
12 x 1,5	1,5	0,8	2,9	22,4	13,3	500
19 x 1,5	1,5	0,8	3,2	26,3	13,3	720
24 x 1,5	1,5	0,8	3,5	30,7	13,3	915
36 x 1,5	1,5	0,8	3,8	35,2	13,3	1305
7 x 2,5	2,0	0,9	2,7	20,0	7,98	470
12 x 2,5	2,0	0,9	3,1	26,2	7,98	705
19 x 2,5	2,0	0,9	3,5	30,9	7,98	1030
24 x 2,5	2,0	0,9	3,9	36,4	7,98	1320
36 x 2,5	2,0	0,9	4,3	41,8	7,98	1880

(*) also available with the green/yellow

N.B. For current rating refer to table "Current carryings. Correction factors. Voltage drops"

H07RN-F Plus cable

TRATOS H07RN-F Plus

Reference Guide EN 50565:

For mobile laying: indoor use, outdoor use and in industrial and agricultural workshops. For supplying industrial and agricultural machines and appliances subject to medium mechanical stresses (e.g. heating plates, inspection lamps, electric tools such as drills, circular saws and domestic electric tools). For fixed laying: it can be used in temporary buildings or huts in building sites. Suitable for connections of constructive elements of lifting appliances and machines. Suitable for use in dry, humid or moist rooms.

If used in protected installations such as tubes or similar closed systems, voltages up to 1000V in a.c. or 750V in d.c. to ground are allowed.

Reference Construction Products Regulation 305/2011 EU and Standard EN 50575:

The cable is suitable for the supply of electricity in buildings and other civil engineering works.

FEATURES AND PERFORMANCES

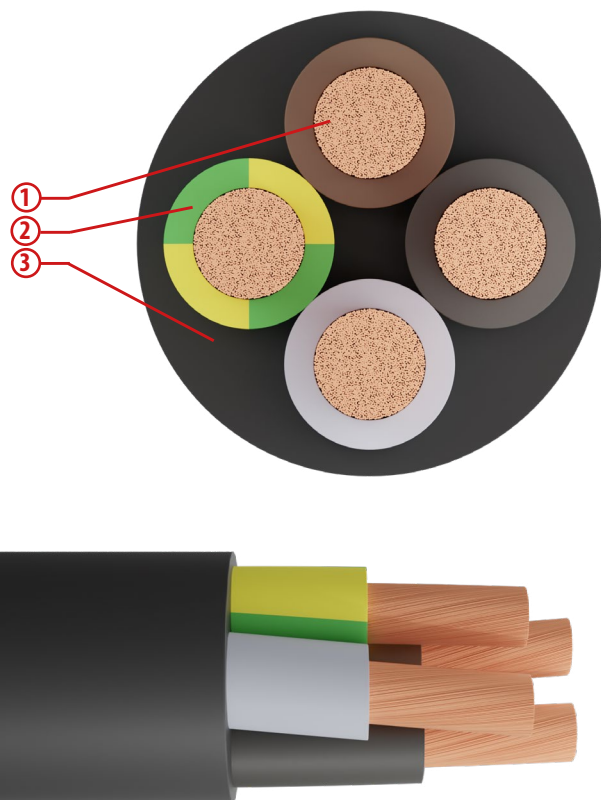

CONSTRUCTION

1. CLASS 5, FLEXIBLE, PLAIN COPPER WIRE
2. SPECIAL RUBBER
3. LS0H RUBBER COMPOUND

Structure and electrical, physical, mechanical requirements: EN 50525-2-51

- Flame propagation EN 60332-1-2
- Low Voltage Directive 2014/35/EU
- RoHS Directive 2011/65/EU

Special features

Good flexibility and mechanical resistance to abrasion, shocks, crushing and lacerations (AG2). Good resistance to atmospheric agents, grease and mineral oils.

Flexibility for minimum 100.000 alternate bending cycles for size below or equal to 4 mm² (standard required by EN 50525-2-21 is 30.000 cycles).

Cable Marking

Tratos LTC H07RN-F Plus IEMMEQU [HAR] [form.] Eca 450/750V - Fixed and Protected 600/1000V [traceability] [year] Made in Italy [metric]

Tratos LTC H07RN-F Plus [form.] Eca 450/750V - Fixed and Protected 600/1000V [traceability] [year] Made in Italy [metric]

Colours

- SINGLE-CORE ●
- TWO-CORE ● ●
- THREE-CORE ● ● ● or ● ● ●
- FOUR-CORE ● ● ● ● or ● ● ● ●
- FIVE-CORE ● ● ● ● ● or ● ● ● ● ●

The cores in multiple cables for signal and control are black, numbered, with or without GREEN/YELLOW

Functional characteristics	
Rated voltage: U _o /U	450/750 V a.c. por fixed and protected laying 0.6/1 kV a.c.
Max. short circuit temperature	250°C

Installation conditions	
Minimum installation temperature	-25°C (*)
Recommended min. bending radius	6 times of the cable diameter for mobile use, 4 times for static use
Recommended maximum tensile stress	15 N/mm ² of the cross-section of the copper for mobile use, 50 N/mm ² for static use

Additional features declared by LTC

In addition to the characteristics of the cable H07RN-F:

- Zero Halogen compounds
- UV resistant
(ISO 4892-2:2013 / IEC 60811-501:2012 / 1000 h)

H07BN4-F

- Heat resistant for maximum conductor temperature 90 °C

H07BB-F

- Resistant to heat and low temperatures
(-50 °C STATIC USE ; -40 °C MOBILE USE) for a maximum conductor temperature of 90 °C
- (*) Minimum installation temperature: -40°C

H07RN8-F

- Water resistant for permanent immersions, class AD8
- Salt water resistance up to 50 bar (500 meters).

Single-core

Formation	Approx. conductor Ø	Average insulation thickness	Average sheath thickness	Max. external Ø	Max. electrical resistance at 20°C	Approx. cable weight	Free laying at 30°	Voltage drop
n° x mm ²	mm	mm	mm	mm	Ω/km	kg/km	A	V/A-Km
1 x 1,5	1,5	0,8	1,4	7,1	13,3	51	24	26,5
1 x 2,5	2,0	0,9	1,4	7,9	7,98	67	33	16,0
1 x 4	2,5	1,0	1,5	9,0	4,95	92	45	9,93
1 x 6	3,0	1,0	1,6	9,8	3,30	121	58	6,63
1 x 10	4,0	1,2	1,8	11,9	1,91	186	80	3,87
1 x 16	5,0	1,2	1,9	13,4	1,21	256	107	2,47
1 x 25	6,2	1,4	2,0	15,8	0,780	368	135	1,61
1 x 35	7,4	1,4	2,2	17,9	0,554	485	169	1,17
1 x 50	8,9	1,6	2,4	20,6	0,386	668	207	0,844
1 x 70	10,5	1,6	2,6	23,3	0,272	905	268	0,609
1 x 95	12,2	1,8	2,8	26,0	0,206	1180	328	0,484
1 x 120	13,8	1,8	3,0	28,6	0,161	1460	383	0,388
1 x 150	15,4	2,0	3,2	31,4	0,129	1810	444	0,325
1 x 185	16,9	2,2	3,4	34,4	0,106	2165	510	0,279
1 x 240	19,5	2,4	3,5	38,3	0,0801	2750	607	0,221
1 x 300	21,6	2,6	3,6	41,9	0,0641	3271	703	0,184
1 x 400	24,8	2,8	3,8	46,8	0,0486	4286	823	0,159
1 x 500	28,5	3,0	4,0	52,0	0,0384	5301	946	0,137
1 x 630	32,8	3,0	4,1	57,0	0,0287	6959	1088	0,122

N.B. Permissible current rating values are according to: - three-phase circuit

Two-core

Formation	Approx. conductor Ø	Average insulation thickness	Average sheath thickness	Max. external Ø	Max. electrical resistance at 20°C	Approx. cable weight	Free laying at 30°	Voltage drop
n° x mm ²	mm	mm	mm	mm	Ω/km	kg/km	A	V/A-Km
2 x 1	1,3	0,8	1,3	10,0	19,5	93	19	45,2
2 x 1,5	1,5	0,8	1,5	11,0	13,3	115	26	30,6
2 x 2,5	2,0	0,9	1,7	13,1	7,98	165	36	18,4
2 x 4	2,5	1,0	1,8	15,1	4,95	225	49	11,4
2 x 6	3,0	1,0	2,0	16,8	3,30	300	63	7,63
2 x 10	4,0	1,2	3,1	22,6	1,91	550	86	4,44
2 x 16	5,0	1,2	3,3	25,7	1,21	745	115	2,84
2 x 25	6,2	1,4	3,6	30,7	0,780	1060	149	1,85

N.B. Permissible current rating values are according to: - two-phase circuit for two-core cables

Three-core

Formation	Approx. conductor \emptyset	Average insulation thickness	Average sheath thickness	Max. external \emptyset	Max. electrical resistance at 20°C	Approx. cable weight	Free laying at 30°	Voltage drop
n° x mm ²	mm	mm	mm	mm	Ω/km	kg/km	A	V/A-Km
3 x 1	1,3	0,8	1,4	10,7	19,5	120	17	45,2
3 x 1,5	1,5	0,8	1,6	11,9	13,3	150	23	30,6
3 x 2,5	2,0	0,9	1,8	14,0	7,98	200	32	18,4
3 x 4	2,5	1,0	1,9	16,2	4,95	295	42	11,4
3 x 6	3,0	1,0	2,1	18,0	3,30	380	54	7,63
3 x 10	4,0	1,2	3,3	24,2	1,91	675	75	4,44
3 x 16	5,0	1,2	3,5	27,6	1,21	950	100	2,84
3 x 25	6,2	1,4	3,8	33,0	0,780	1355	127	1,85
3 x 35	7,4	1,4	4,1	37,1	0,554	1765	158	1,34
3 x 50	8,9	1,6	4,5	42,9	0,386	2415	192	0,962
3 x 70	10,5	1,6	4,8	48,3	0,272	3230	246	0,691
3 x 95	12,2	1,8	5,3	54,0	0,206	4225	298	0,546
3 x 120	13,8	1,8	5,6	60,0	0,161	5190	346	0,438
3 x 150	15,4	2,0	6,0	66,0	0,129	6415	399	0,366
3 x 185	16,9	2,2	6,4	72,0	0,106	7700	456	0,280
3 x 240	19,5	2,4	7,10	82,0	0,0801	9458	538	0,230
3 x 300	22,0	2,6	7,70	90,0	0,0641	11635	621	0,200

(*) also available without the green/yellow

N.B. Permissible current rating values are according to: - three-phase circuit for three-core cables

Four-core

Formation	Approx. conductor \emptyset	Average insulation thickness	Average sheath thickness	Max. external \emptyset	Max. electrical resistance at 20°C	Approx. cable weight	Free laying at 30°	Voltage drop
n° x mm ²	mm	mm	mm	mm	Ω/km	kg/km	A	V/A-Km
4G1	1,3	0,8	1,5	11,9	19,5	145	17	39,0
4G1,5	1,5	0,8	1,7	13,1	13,3	175	23	26,5
4G2,5	2,0	0,9	1,9	15,5	7,98	255	32	16,0
4G4	2,5	1,0	2,0	17,9	4,95	355	42	9,93
4G6	3,0	1,0	2,3	20,0	3,30	485	54	6,63
4G10	4,0	1,2	3,4	26,5	1,91	845	75	3,87
4G16	5,0	1,2	3,6	30,1	1,21	1185	100	2,47
4G25	6,2	1,4	4,1	36,6	0,780	1730	127	1,61
4G35	7,4	1,4	4,4	41,1	0,554	2250	158	1,17
4G50	8,9	1,6	4,8	47,5	0,386	3085	192	0,844
4G70	10,5	1,6	5,2	54,0	0,272	4145	246	0,609
4G95	12,2	1,8	5,9	61,0	0,206	5465	298	0,484
4G120	13,8	1,8	6,0	66,0	0,161	6670	346	0,388
4G150	15,4	2,0	6,5	73,0	0,129	8290	399	0,325
4G185	16,5	2,2	7,0	80,0	0,106	9385	456	0,280

(*) also available without the green/yellow

N.B. Permissible current rating values are according to: - three-phase circuit for three-core cables

Five-core

Formation	Approx. conductor \emptyset	Average insulation thickness	Average sheath thickness	Max. external \emptyset	Max. electrical resistance at 20°C	Approx. cable weight	Free laying at 30°	Voltage drop
$n^\circ \times \text{mm}^2$	mm	mm	mm	mm	Ω/km	kg/km	A	V/A·Km
5G1	1,3	0,8	1,6	13,1	19,5	180	17	39,0
5G1,5	1,5	0,8	1,8	14,4	13,3	220	23	26,5
5G2,5	2,0	0,9	2,0	17,0	7,98	310	32	16,0
5G4	2,5	1,0	2,2	19,9	4,95	445	42	9,93
5G6	3,0	1,0	2,5	22,2	3,30	605	54	6,63
5G10	4,0	1,2	3,6	29,1	1,91	1035	75	3,87
5G16	5,0	1,2	3,9	33,3	1,21	1465	100	2,47
5G25	6,2	1,4	4,4	40,4	0,780	2145	127	1,61
5G35	7,4	1,4	4,6	45,1	0,554	2579	158	1,17
5G50	8,9	1,6	5,2	53	0,386	3594	192	0,844
5G70	10,5	1,6	5,7	60	0,272	4837	246	0,609
5G95	12,2	1,8	6,3	67	0,206	6269	298	0,484
5G120 **	13,8	1,8	6,3	-	0,161	7770	346	0,375

(*) also available without the green/yellow

(**) This formation is not IMQ HAR

N.B. Permissible current rating values are according to: - three-phase circuit for three-core cables

Multi-core / signalling and control

Formation	Approx. conductor \emptyset	Average insulation thickness	Average sheath thickness	Max. external \emptyset	Max. electrical resistance at 20°C	Approx. cable weight	Free laying at 30°	Voltage drop
$n^\circ \times \text{mm}^2$	mm	mm	mm	mm	Ω/km	kg/km	A	V/A·Km
7G1,5	1,5	0,8	2,5	17,2	13,3	355	16	30,7
12G1,5	1,5	0,8	2,9	22,4	13,3	505	16	30,7
12G2,5	2,0	0,9	3,1	26,2	7,98	710	25	18,4
36G2,5	2,0	0,9	4,3	41,8	7,98	1750	13	18,4

(*) also available without the green/yellow

N.B. Permissible current rating values are according to: - all conductors are charged (except for the green/yellow).

H07BN4-F cable

TRATOS H07BN4-F

Reference Guide EN 50565:

For mobile laying: indoor use, outdoor use and in industrial and agricultural workshops. For supplying industrial and agricultural machines and appliances subject to medium mechanical stresses (e.g. heating plates, inspection lamps, electric tools such as drills, circular saws and domestic electric tools).

For fixed laying: it can be used in temporary buildings or huts in building sites. Suitable for connections of constructive elements of lifting appliances and machines. Suitable for use in dry, humid or moist rooms (AD6). Skin contact should be avoided when operating these cables unless calculations show that the surface temperature does not exceed 50°C. If used in protected installations such as tubes or similar closed systems, voltages up to 1000V in a.c. or 750V in d.c. to ground are allowed.

Reference Construction Products Regulation 305/2011 EU and Standard EN 50575:

The cable is suitable for the supply of electricity in buildings and other civil engineering works.

FEATURES AND PERFORMANCES

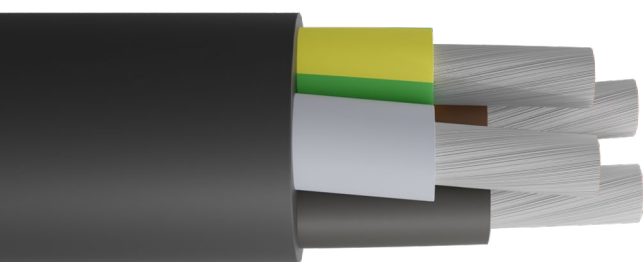
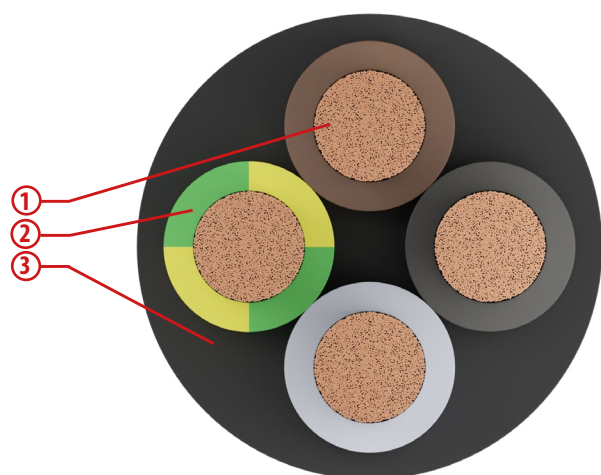

CONSTRUCTION

1. CLASS 5, FLEXIBLE, PLAIN COPPER WIRE
2. SPECIAL RUBBER, EI7 QUALITY
3. RUBBER, EM7 QUALITY

Structure and electrical, physical, mechanical requirements: EN 50525-2-51

- Low Voltage Directive 2014/35/EU
- RoHS Directive 2011/65/EU

Special features

Heat resistant for maximum conductor temperature 90 °C. Good flexibility and mechanical resistance to abrasion, shocks, crushing and lacerations. Good resistance to atmospheric agents, grease and mineral oils. UV-resistant.

Cable Marking

Tratos LTC IEMMEQU [HAR] H07BN4-F [form.] Eca 450/750V - Fixed and Protected 600/1000V [order number] [year] Made in Italy [metric]

Colours

- SINGLE-CORE ●
- TWO-CORE ● ●
- THREE-CORE ● ● ● or ● ● ●
- FOUR-CORE ● ● ● ● or ● ● ● ●
- FIVE-CORE ● ● ● ● ● or ● ● ● ● ●

The cores in multiple cables for signal and control are black, numbered, with or without GREEN/YELLOW

Installation conditions	
Minimum installation temperature	-25°C (*)
Recommended min. bending radius	6 times of the cable diameter for mobile use, 4 times for static use
Recommended maximum tensile stress	15 N/mm ² of the cross-section of the copper for mobile use, 50 N/mm ² for static use

Functional characteristics	
Rated voltage: U ₀ /U	450/750 V a.c. for fixed and protected installation 0,6/1 kV a.c.
Max. operating temperature	90°C
Min. operating temperature	-40°C (without mechanical shocks)
Max. short circuit temperature	250°C

Single-core

Formation	Approx. conductor Ø	Average insulation thickness	Average sheath thickness	Max. external Ø	Max. electrical resistance at 20°C	Approx. cable weight	Free laying at 30°	Voltage drop
n° x mm ²	mm	mm	mm	mm	Ω/km	kg/km	A	V/A·Km
1 x 1,5	1,5	0,8	1,4	7,1	13,7	48	24	26,5
1 x 2,5	2,0	0,9	1,4	7,9	8,21	62	33	16,0
1 x 4	2,5	1,0	1,5	9,0	5,09	86	45	9,93
1 x 6	3,0	1,0	1,6	9,8	3,39	110	58	6,63
1 x 10	4,0	1,2	1,8	11,9	1,95	175	80	3,87
1 x 16	5,0	1,2	1,9	13,4	1,24	240	107	2,47
1 x 25	6,2	1,4	2,0	15,8	0,795	345	135	1,61
1 x 35	7,4	1,4	2,2	17,9	0,565	460	169	1,17
1 x 50	8,9	1,6	2,4	20,6	0,393	665	207	0,844
1 x 70	10,5	1,6	2,6	23,3	0,277	860	268	0,609
1 x 95	12,2	1,8	2,8	26,0	0,210	1100	328	0,484
1 x 120	13,8	1,8	3,0	28,6	0,164	1390	383	0,388
1 x 150	15,4	2,0	3,2	31,4	0,132	1715	444	0,325
1 x 185	16,9	2,2	3,4	34,4	0,108	2070	510	0,279
1 x 240	19,5	2,4	3,5	38,3	0,0817	2670	607	0,221
1 x 300	21,6	2,6	3,6	41,9	0,0654	3230	703	0,184
1 x 400	24,8	2,8	3,8	46,8	0,0495	4185	823	0,159
1 x 500	28,5	3,0	4,0	52,0	0,0391	5170	946	0,137
1 x 630	32,8	3,0	4,1	57,0	0,0292	6715	1088	0,122

N.B. Permissible current rating values are according to: - three-phase circuit

Two-core

Formation	Approx. conductor Ø	Average insulation thickness	Average sheath thickness	Max. external Ø	Max. electrical resistance at 20°C	Approx. cable weight	Free laying at 30°	Voltage drop
n° x mm ²	mm	mm	mm	mm	Ω/km	kg/km	A	V/A·Km
2 x 1	1,3	0,8	1,3	10,0	20,0	92	19	45,2
2 x 1,5	1,5	0,8	1,5	11,0	13,7	110	26	30,6
2 x 2,5	2,0	0,9	1,7	13,1	8,21	160	36	18,4
2 x 4	2,5	1,0	1,8	15,1	5,09	220	49	11,4
2 x 6	3,0	1,0	2,0	16,8	3,39	290	63	7,63
2 x 10	4,0	1,2	3,1	22,6	1,95	500	86	4,44
2 x 16	5,0	1,2	3,3	25,7	1,24	685	115	2,84
2 x 25	6,2	1,4	3,6	30,7	0,795	980	149	1,85

N.B. Permissible current rating values are according to: - two-phase circuit for two-core cables

Three-core

Formation	Approx. conductor \emptyset	Average insulation thickness	Average sheath thickness	Max. external \emptyset	Max. electrical resistance at 20°C	Approx. cable weight	Free laying at 30°	Voltage drop
n° x mm ²	mm	mm	mm	mm	Ω /km	kg/km	A	V/A-Km
3G1	1,3	0,8	1,4	10,7	20,0	110	19	45,2
3G1,5	1,5	0,8	1,6	11,9	13,7	140	26	30,6
3G2,5	2,0	0,9	1,8	14,0	8,21	195	36	18,4
3G4	2,5	1,0	1,9	16,2	5,09	270	49	11,4
3G6	3,0	1,0	2,1	18,0	3,39	360	63	7,63
3G10	4,0	1,2	3,3	24,2	1,95	620	86	4,44
3G16	5,0	1,2	3,5	27,6	1,24	860	115	2,84
3G25	6,2	1,4	3,8	33,0	0,795	1240	149	1,85
3G35	7,4	1,4	4,1	37,1	0,565	1635	185	1,34
3G50	8,9	1,6	4,5	42,9	0,393	2260	225	0,962
3G70	10,5	1,6	4,8	48,3	0,277	3010	255	0,691
3G95	12,2	1,8	5,3	54,0	0,210	3880	289	0,546
3G120	13,8	1,8	5,6	60,0	0,164	4830	352	0,438
3G150	15,4	2,0	6,0	66,0	0,132	5970	410	0,366
3G185	16,9	2,2	6,4	72,0	0,108	7225	473	0,280
3G240	19,5	2,4	7,10	82,0	0,0817	9360	641	0,230
3G300	22,0	2,6	7,70	90,0	0,0654	11590	741	0,200

(*) also available without the green/yellow

N.B. Permissible current rating values are according to: - three-phase circuit for three-core cables

Four-core

Formation	Approx. conductor \emptyset	Average insulation thickness	Average sheath thickness	Max. external \emptyset	Max. electrical resistance at 20°C	Approx. cable weight	Free laying at 30°	Voltage drop
n° x mm ²	mm	mm	mm	mm	Ω /km	kg/km	A	V/A-Km
4G1	1,3	0,8	1,5	11,9	20,0	140	17	39,0
4G1,5	1,5	0,8	1,7	13,1	13,7	170	23	26,5
4G2,5	2,0	0,9	1,9	15,5	8,21	240	32	16,0
4G4	2,5	1,0	2,0	17,9	5,09	335	42	9,93
4G6	3,0	1,0	2,3	20,0	3,39	455	54	6,63
4G10	4,0	1,2	3,4	26,5	1,95	760	75	3,87
4G16	5,0	1,2	3,6	30,1	1,24	1065	100	2,47
4G25	6,2	1,4	4,1	36,6	0,795	1565	127	1,61
4G35	7,4	1,4	4,4	41,1	0,565	2055	158	1,17
4G50	8,9	1,6	4,8	47,5	0,393	2855	192	0,844
4G70	10,5	1,6	5,2	54,0	0,277	3825	246	0,609
4G95	12,2	1,8	5,9	61,0	0,210	4975	298	0,484
4G120	13,8	1,8	6,0	66,0	0,164	6145	346	0,388
4G150	15,4	2,0	6,5	73,0	0,132	7620	399	0,325
4G185	16,5	2,2	7,0	80,0	0,108	9235	456	0,280

(*) also available without the green/yellow

N.B. Permissible current rating values are according to: - three-phase circuit for three-core cables

Five-core

Formation	Approx. conductor \emptyset	Average insulation thickness	Average sheath thickness	Max. external \emptyset	Max. electrical resistance at 20°C	Approx. cable weight	Free laying at 30°	Voltage drop
$n^\circ \times \text{mm}^2$	mm	mm	mm	mm	Ω/km	kg/km	A	V/A·Km
5G1	1,3	0,8	1,6	13,1	20,0	170	17	39,0
5G1,5	1,5	0,8	1,8	14,4	13,7	205	23	26,5
5G2,5	2,0	0,9	2,0	17,0	8,21	295	32	16,0
5G4	2,5	1,0	2,2	19,9	5,09	415	42	9,93
5G6	3,0	1,0	2,5	22,2	3,39	560	54	6,63
5G10	4,0	1,2	3,6	29,1	1,95	930	75	3,87
5G16	5,0	1,2	3,9	33,3	1,24	1310	100	2,47
5G25	6,2	1,4	4,4	40,4	0,795	1925	127	1,61
5G35	7,4	1,4	4,6	45,1	0,565	2470	158	1,17
5G50	8,9	1,6	5,2	53	0,393	3470	192	0,844
5G70	10,5	1,6	5,7	60	0,277	4685	246	0,609
5G95	12,2	1,8	6,3	67	0,210	6065	298	0,484

(*) also available without the green/yellow

N.B. Permissible current rating values are according to: - three-phase circuit for three-core cables

Multi-core / signalling and control

Formation	Approx. conductor \emptyset	Average insulation thickness	Average sheath thickness	Max. external \emptyset	Max. electrical resistance at 20°C	Approx. cable weight	Free laying at 30°	Voltage drop
$n^\circ \times \text{mm}^2$	mm	mm	mm	mm	Ω/km	kg/km	A	V/A·Km
7G1,5	1,5	0,8	2,5	17,2	13,7	340	16	30,7
12G1,5	1,5	0,8	2,9	22,4	13,7	505	16	30,7
12G2,5	2,0	0,9	3,1	26,2	8,21	710	25	18,4

(*) also available without the green/yellow

N.B. Permissible current rating values are according to: - all conductors are charged (except for the green/yellow).

TRATOS General Cables®

H07ZZ-F (Cca) cable

TRATOS H07ZZ-F (Cca)

Reference Guide EN 50565:

In locations where a low level of emission of smoke and corrosive gases are required in case of fire or burning. For mobile laying: indoor use, outdoor use and in industrial and agricultural workshops.

For supplying industrial and agricultural machines and appliances subject to medium mechanical stresses (e.g. heating plates, inspection lamps, electric tools such as drills, circular saws and domestic electric tools).

For fixed laying: it can be used in temporary buildings or huts in building sites. Suitable for connections of constructive elements of lifting appliances and machines. Suitable for use in dry, humid or moist rooms (AD2).

If used in protected installations such as tubes or similar closed systems, voltages up to 1000V in a.c. or 750V in d.c. to ground are allowed.

Reference Construction Products Regulation 305/2011 EU and Standard EN 50575:

Given its properties of limiting the development of fire, heat emission and noxious fumes, the cable is suitable for the supply of electricity in buildings and other civil engineering works.

FEATURES AND PERFORMANCES

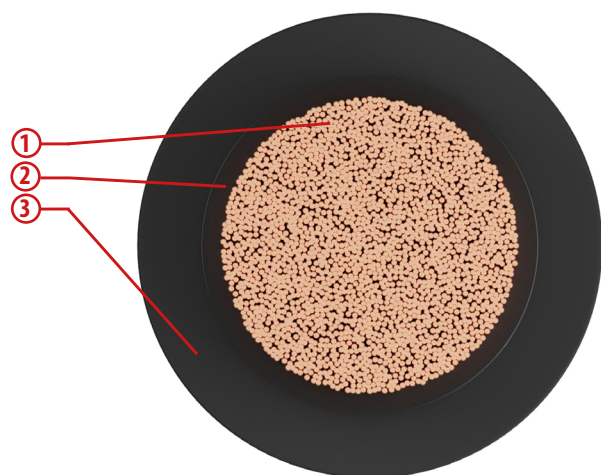

CONSTRUCTION

1. CLASS 5, FLEXIBLE, PLAIN COPPER WIRE
2. LSOH RUBBER COMPOUND, E18 QUALITY
3. LSOH CROSSLINKED POLYMER, EM8 QUALITY

LSOH = Low Smoke Zero Halogen

Structure and electrical, physical, mechanical requirements: EN 50525-3-21

- | | |
|-------------------------|---------------|
| • Fire propagation | EN 60332-3-24 |
| • Low Voltage Directive | 2014/35/EU |
| • RoHS Directive | 2011/65/EU |

Special features

Good flexibility and mechanical resistance to abrasion, shocks, crushing and lacerations.

Good resistance to atmospheric agents, grease and mineral oils. UV-resistant.

Cable Marking

Tratos LTC H07ZZ-F [form.] 450/750V Halogen Free Cca-s1b,d1,a1 IMQ [HAR] [order number] [year] Made in Italy (CE logo) [metric]

Tratos LTC H07ZZ-F [form.] 450/750V Halogen Free Cca-s1b,d1,a1 [order number] [year] Made in Italy (CE logo) [metric]

Colours

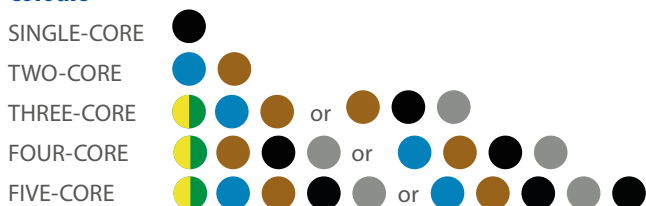

The cores in multiple cables for signal and control are black, numbered, with or without GREEN/YELLOW

Installation conditions	
Minimum installation temperature	-5°C
Recommended min. bending radius	6 times of the cable diameter for mobile use, 4 times for static use
Recommended maximum tensile stress	15 N/mm ² of the cross-section of the copper for mobile use, 50 N/mm ² for static use

Functional characteristics	
Rated voltage: U ₀ /U	450/750 V a.c. for fixed and protected installation 0,6/1 kV a.c.
Max. operating temperature	90°C
Min. operating temperature	-20°C (without mechanical shocks)
Max. short circuit temperature	250°C

Single-core

Formation	Approx. conductor Ø	Average insulation thickness	Average sheath thickness	Max. external Ø	Max. electrical resistance at 20°C	Approx. cable weight	Current rating in air at 30°C
n° x mm ²	mm	mm	mm	mm	Ω/km	kg/km	A
1 x 10	4,0	1,2	1,8	11,9	1,91	235	80
1 x 16	5,0	1,2	1,9	13,4	1,21	315	107
1 x 25	6,2	1,4	2,0	15,8	0,780	430	135
1 x 35	7,4	1,4	2,2	17,9	0,554	540	169
1 x 50	8,9	1,6	2,4	20,6	0,386	750	207
1 x 70	10,5	1,6	2,6	23,3	0,272	1005	268
1 x 95	12,2	1,8	2,8	26,0	0,206	1300	328
1 x 120	13,8	1,8	3,0	28,6	0,161	1610	383
1 x 150	15,4	2,0	3,2	31,4	0,129	1940	444
1 x 185	16,9	2,2	3,4	34,4	0,106	2330	510
1 x 240	19,5	2,4	3,5	38,3	0,0801	2955	607
1 x 300	21,6	2,6	3,6	41,9	0,0641	3600	703
1 x 400	25,1	2,8	3,8	46,8	0,0486	4380	823
1 x 500	28,5	3,0	4,0	52,0	0,0384	5410	946
1 x 630	32,8	3,0	4,1	57,0	0,0287	7095	1088

N.B. Permissible current rating values are according to: - three conductors charged

Two-core and Three-core

Formation	Approx. conductor Ø	Average insulation thickness	Average sheath thickness	Max. external Ø	Max. electrical resistance at 20°C	Approx. cable weight	Current rating in air at 30°C
n° x mm ²	mm	mm	mm	mm	Ω/km	kg/km	A
2 x 16	5,0	1,2	3,3	25,7	1,21	1498	115
2 x 25	6,2	1,4	3,6	30,7	0,780	2024	149
3 x 50	8,9	1,6	4,5	42,9	0,386	2472	192
3 x 70	10,5	1,6	4,8	48,3	0,272	3279	246
3 x 95	12,2	1,8	5,3	54,0	0,206	4234	298
3 x 120	13,8	1,8	5,6	60,0	0,161	4850	346
3 x 150	15,4	2,0	6,0	66,0	0,129	5960	399
3 x 185	16,9	2,2	6,4	72,0	0,106	7220	456

N.B. Permissible current rating values are according to:
 - two conductors charged for two-core cables
 - three conductors charged for three-core cables

Four-core and Five-core

Formation	Approx. conductor Ø	Average insulation thickness	Average sheath thickness	Max. external Ø	Max. electrical resistance at 20°C	Approx. cable weight	Current rating in air at 30°C
n° x mm ²	mm	mm	mm	mm	Ω/km	kg/km	A
4 x 95	12,2	1,8	5,9	61,0	0,206	5399	298
4 x 120	13,8	1,8	6,0	66,0	0,161	6240	346
4 x 150	15,4	2,0	6,5	73,0	0,129	7590	399
4 x 185	16,9	2,2	7,0	80,0	0,106	9245	456
4 x 240	19,5	2,4	7,7	91,0	0,0801	11970	538
5 x 70 *	10,5	1,6	5,6	/	0,272	5030	246
5 x 95 *	12,2	1,8	6,2	/	0,206	6175	298
5 x 120 *	13,8	1,8	6,2	/	0,161	7500	346
5 x 150 *	15,4	2,0	6,2	/	0,129	9250	399
5 x 185 *	16,9	2,2	6,2	/	0,106	11275	456
5 x 240 *	19,5	2,4	6,2	/	0,0801	14585	538

* FORMATION WITHOUT CERTIFICATION [HAR]

N.B. Permissible current rating values are according to:

- three conductors charged

CABLES FOR A MOVING WORLD

TRATOS[®] ENERGY DNOs

Tratos Utility cables are designed and tested to meet relevant UK, European and International standards. Manufactured in state of the art manufacturing facilities, the company's purpose-built, in-house Fire, Chemical, Electrical and Physical testing facilities and laboratories deliver peace of mind to customers ensuring their choice of Utility cable products meet all statutory and regulatory requirements.



www.tratosgroup.com



TRATOS General Cables®

H07ZZ-F (Dca) cable

TRATOS H07ZZ-F (Dca)

Reference Guide EN 50565:

In locations where a low level of emission of smoke and corrosive gases are required in case of fire or burning. For mobile laying: indoor use, outdoor use and in industrial and agricultural workshops.

For supplying industrial and agricultural machines and appliances subject to medium mechanical stresses (e.g. heating plates, inspection lamps, electric tools such as drills, circular saws and domestic electric tools).

For fixed laying: it can be used in temporary buildings or huts in building sites. Suitable for connections of constructive elements of lifting appliances and machines. Suitable for use in dry, humid or moist rooms (AD2).

If used in protected installations such as tubes or similar closed systems, voltages up to 1000V in a.c. or 750V in d.c. to ground are allowed.

Reference Construction Products Regulation 305/2011 EU and Standard EN 50575:

Given its properties of limiting the development of fire, heat emission and noxious fumes, the cable is suitable for the supply of electricity in buildings and other civil engineering works.

FEATURES AND PERFORMANCES

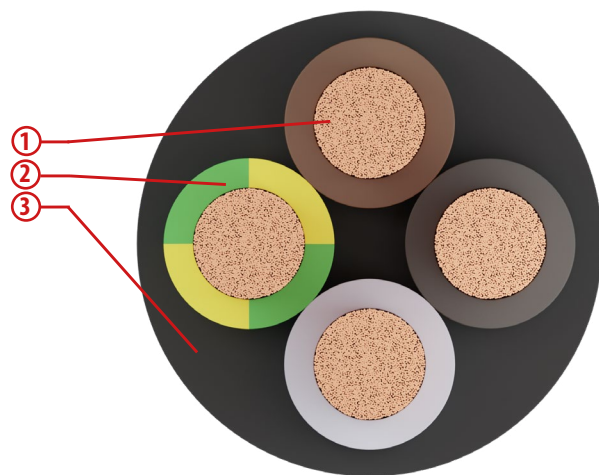

CONSTRUCTION

1. CLASS 5, FLEXIBLE, PLAIN COPPER WIRE
2. LSOH RUBBER COMPOUND, E18 QUALITY
3. LSOH CROSSLINKED POLYMER, EM8 QUALITY

LSOH = Low Smoke Zero Halogen

Structure and electrical, physical, mechanical requirements: EN 50525-3-21

- | | |
|-------------------------|---------------|
| • Fire propagation | EN 60332-3-24 |
| • Low Voltage Directive | 2014/35/EU |
| • RoHS Directive | 2011/65/EU |

Special features

Good flexibility and mechanical resistance to abrasion, shocks, crushing and lacerations.

Good resistance to atmospheric agents, grease and mineral oils.
UV-resistant.

Cable Marking

Tratos LTC H07ZZ-F [form.] 450/750V Halogen Free Dca-s2,d2,a2
IEMMEQU [HAR] [order number] [year] Made in Italy (CE logo)
[metric]

Colours

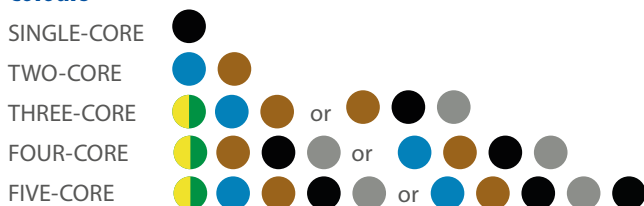

The cores in multiple cables for signal and control are black, numbered, with or without GREEN/YELLOW

Installation conditions	
Minimum installation temperature	-5°C
Recommended min. bending radius	6 times of the cable diameter for mobile use, 4 times for static use
Recommended maximum tensile stress	15 N/mm ² of the cross-section of the copper for mobile use, 50 N/mm ² for static use

Functional characteristics	
Rated voltage: U ₀ /U	450/750 V a.c. for fixed and protected installation 0,6/1 kV a.c.
Max. operating temperature	90°C
Min. operating temperature	-20°C (without mechanical shocks)
Max. short circuit temperature	250°C

Single-core

Formation	Approx. conductor Ø	Average insulation thickness	Average sheath thickness	Max. external Ø	Max. electrical resistance at 20°C	Approx. cable weight	Current rating in air at 30°C
n° x mm ²	mm	mm	mm	mm	Ω/km	kg/km	A
1 x 10	4,0	1,2	1,8	11,9	1,91	210	80
1 x 16	5,0	1,2	1,9	13,4	1,21	275	107
1 x 25	6,2	1,4	2,0	15,8	0,780	380	135
1 x 35	7,4	1,4	2,2	17,9	0,554	485	169
1 x 50	8,9	1,6	2,4	20,6	0,386	670	207
1 x 70	10,5	1,6	2,6	23,3	0,272	895	268
1 x 95	12,2	1,8	2,8	26,0	0,206	1155	328
1 x 120	13,8	1,8	3,0	28,6	0,161	1440	383
1 x 150	15,4	2,0	3,2	31,4	0,129	1780	444
1 x 185	16,9	2,2	3,4	34,4	0,106	2140	510
1 x 240	19,5	2,4	3,5	38,3	0,0801	2720	607
1 x 300	21,6	2,6	3,6	41,9	0,0641	3300	703
1 x 400	25,1	2,8	3,8	46,8	0,0486	4420	823
1 x 500	28,5	3,0	4,0	52,0	0,0384	5405	946
1 x 630	32,8	3,0	4,1	57,0	0,0287	7070	1088

N.B. Permissible current rating values are according to: - three conductors charged

Two-core and Three-core

Formation	Approx. conductor \emptyset	Average insulation thickness	Average sheath thickness	Max. external \emptyset	Max. electrical resistance at 20°C	Approx. cable weight	Current rating in air at 30°C
n° x mm ²	mm	mm	mm	mm	Ω /km	kg/km	A
2 x 1,5	1,5	0,8	1,5	11,0	13,3	305	26
2 x 2,5	2,0	0,9	1,7	13,1	7,98	417	36
2 x 4	2,5	1,0	1,8	15,1	4,95	544	49
2 x 6	3,0	1,0	2,0	16,8	3,30	675	63
2 x 10	4,0	1,2	3,1	22,6	1,91	1198	86
2 x 16	5,0	1,2	3,3	25,7	1,21	1498	115
2 x 25	6,2	1,4	3,6	30,7	0,780	2024	149
3 x 1,5	1,5	0,8	1,6	11,9	13,3	152	23
3 x 2,5	2,0	0,8	1,8	14,0	7,98	215	32
3 x 4	2,5	1,0	1,9	16,2	4,95	295	42
3 x 6	3,0	1,0	2,1	18,0	3,30	397	54
3 x 10	4,0	1,2	3,3	24,2	1,91	694	75
3 x 16	5,0	1,2	3,5	27,6	1,21	946	100
3 x 25	6,2	1,4	3,8	33,0	0,780	1371	127
3 x 35	7,4	1,4	4,1	37,1	0,554	1792	158
3 x 50	8,9	1,6	4,5	42,9	0,386	2472	192
3 x 70	10,5	1,6	4,8	48,3	0,272	3279	246
3 x 95	12,2	1,8	5,3	54,0	0,206	4234	298

N.B. Permissible current rating values are according to:
 - two conductors charged for two-core cables
 - three conductors charged for three-core cables

Four-core and Five-core

Formation	Approx. conductor \emptyset	Average insulation thickness	Average sheath thickness	Max. external \emptyset	Max. electrical resistance at 20°C	Approx. cable weight	Current rating in air at 30°C
n° x mm ²	mm	mm	mm	mm	Ω /km	kg/km	A
4 x 1,5	1,5	0,8	1,7	13,1	13,3	184	23
4 x 2,5	2,0	0,8	1,9	15,5	7,98	264	32
4 x 4	2,5	0,9	2,0	17,9	4,95	364	42
4 x 6	3,0	1,0	2,3	20,0	3,30	495	54
4 x 10	4,0	1,2	3,4	26,5	1,91	842	75
4 x 16	5,0	1,2	3,6	30,1	1,21	1157	100
4 x 25	6,2	1,4	4,1	36,6	0,780	1720	127
4 x 35	7,4	1,4	4,4	41,1	0,554	2257	158
4 x 50	8,9	1,6	4,8	47,5	0,386	3101	192
4 x 70	10,5	1,6	5,2	54,0	0,272	4153	246
4 x 95	12,2	1,8	5,9	61,0	0,206	5399	298
5 x 1,5	1,5	0,8	1,8	14,4	13,3	249	23
5 x 2,5	2,0	0,9	2,0	17,0	7,98	316	32
5 x 4	2,5	1,0	2,2	19,9	4,95	445	42
5 x 6	3,0	1,0	2,5	22,2	3,30	603	54
5 x 10	4,0	1,2	3,6	29,1	1,91	1016	75
5 x 16	5,0	1,2	3,9	33,3	1,21	1413	100
5 x 25	6,2	1,4	4,4	40,4	0,780	2084	127
5 x 35 *	7,4	1,4	4,6	/	0,554	2689	158
5 x 50 *	8,9	1,6	5,2	/	0,386	3755	192
5 x 70 *	10,5	1,6	5,7	/	0,272	5030	246

* FORMATION WITHOUT CERTIFICATION [HAR]

N.B. Permissible current rating values are according to:

- three conductors charged

H07BQ-F cable

TRATOS H07BQ-F

Reference Guide EN 50565:

They can be used both indoors and outdoors, in dry, damp or wet conditions. Suitable for heavy-duty uses and to power industrial and farm machinery. For connections undergoing moderate mechanical stresses, such as those in power tools (drills, circular saws, electrical home appliances) and heaters, as long as they do not touch hot parts and are not exposed to heat radiation. Avoid skin contact if they are used at high operating temperatures. Suitable to be used for fixed installations on temporary building fronts and workmen's shelter at work sites. Suitable up to 1000 V A.C. for fixed installations and duly shielded (in ducts and equipment). Not suitable for underground laying, even if shielded.

Reference Construction Products Regulation 305/2011 EU and Standard EN 50575:

The cable is suitable for the supply of electricity in buildings and other civil engineering works.

FEATURES AND PERFORMANCES

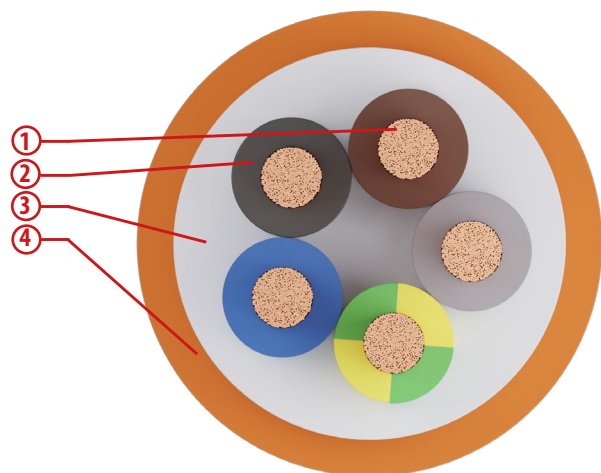

CONSTRUCTION

1. CLASS 5, FLEXIBLE, PLAIN COPPER WIRE
2. EPR RUBBER COMPOUND, QUALITY EI6
3. LSOH RUBBER, PENETRATING BETWEEN THE CORES
4. LSOH TPU POLYURETHANE

LSOH = Low Smoke Zero Halogen

Structure and electrical, physical, mechanical requirements: EN 50525-3-21

• Halogen free	IEC 60754-1
• No corrosive gases	IEC 60754-2
• Oil resistant	according to EN 50363-10-2 EN 60811-404 (24 Std. / 100 °C) (ex EN 60811-2-1)
• Low Voltage Directive	2014/35/EU
• RoHS Directive	2011/65/EU

Special features

Good resistance to mechanical stress and abrasion.
Good flexibility and behaviour at low temperatures.
Good resistance to UV (ISO 4892-2).
Absence of halogens. Sea water resistant.

Cable Marking

Tratos LTC IEMMEQU [HAR] H07BQ-F [form.] Eca [order number]
[year] Made in Italy [metric]

Colours

TWO-CORE



THREE-CORE

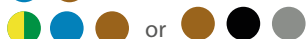

FOUR-CORE

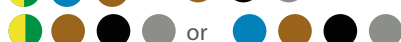

FIVE-CORE



Installation conditions	
Minimum installation temperature	-40°C
Recommended min. bending radius	6 times of the cable diameter for mobile use, 4 times for static use
Recommended maximum tensile stress	15 N/mm ² of the cross-section of the copper for mobile use, 50 N/mm ² for static use

Functional characteristics	
Rated voltage: U ₀ /U	450/750 V (max 480/820 V a.c.) 560/1120 V (max 620/1240 V d.c.)
Max. operating temperature	90°C
Min. operating temperature	-60°C (without mechanical shocks)
Max. short circuit temperature	250°C

Two-core

Formation	Approx. conductor Ø	Average insulation thickness	Average sheath thickness	Max. external Ø	Max. electrical resistance at 20°C	Approx. cable weight	Free laying at 30°
n° x mm ²	mm	mm	mm	mm	Ω/km	kg/km	A
2 x 1	1,3	0,6	0,9	9,0	19,5	75	19
2 x 1,5	1,5	0,8	1,0	9,8	13,3	90	26
2 x 2,5	2,0	0,9	1,1	11,6	7,98	130	36
2 x 4	2,5	1,0	1,2	13,7	4,95	185	49
2 x 6	3,0	1,0	1,3	15,1	3,30	235	63
2 x 10	4,0	1,2	2,0	19,9	1,91	390	86
2 x 16	5,0	1,2	2,1	22,8	1,21	550	115

N.B. Permissible current rating values are according to: - two-phase circuit for two-core cables

Three-core

Formation	Approx. conductor Ø	Average insulation thickness	Average sheath thickness	Max. external Ø	Max. electrical resistance at 20°C	Approx. cable weight	Free laying at 30°
n° x mm ²	mm	mm	mm	mm	Ω/km	kg/km	A
3G1	1,3	0,6	0,9	9,5	19,5	90	17
3G1,5	1,5	0,8	1,0	10,4	13,3	110	23
3G2,5	2,0	0,9	1,1	12,4	7,98	160	32
3G4	2,5	1,0	1,2	14,5	4,95	220	42
3G6	3,0	1,0	1,4	16,3	3,30	305	54
3G10	4,0	1,2	2,1	21,4	1,91	500	75
3G16	5,0	1,2	2,3	24,7	1,21	720	100

(*) also available without the green/yellow

N.B. Permissible current rating values are according to:

- three-phase circuit for three-core cables

TRATOS General Cables®

Four-core

Formation	Approx. conductor \emptyset	Average insulation thickness	Average sheath thickness	Max. external \emptyset	Max. electrical resistance at 20°C	Approx. cable weight	Free laying at 30°
$n^\circ \times \text{mm}^2$	mm	mm	mm	mm	Ω/km	kg/km	A
4G1	1,3	0,6	0,9	10,7	19,5	115	17
4G1,5	1,5	0,8	1,1	11,6	13,3	140	23
4G2,5	2,0	0,9	1,2	13,8	7,98	195	32
4G4	2,5	1,0	1,3	16,2	4,95	280	42
4G6	3,0	1,0	1,5	18,1	3,30	385	54
4G10	4,0	1,2	2,2	23,6	1,91	630	75
4G16	5,0	1,2	2,3	27,0	1,21	900	100

(*) also available without the green/yellow

N.B. Permissible current rating values are according to:

- three-phase circuit for three-core cables

Five-core

Formation	Approx. conductor \emptyset	Average insulation thickness	Average sheath thickness	Max. external \emptyset	Max. electrical resistance at 20°C	Approx. cable weight	Free laying at 30°
$n^\circ \times \text{mm}^2$	mm	mm	mm	mm	Ω/km	kg/km	A
5G1	1,3	0,8	1,0	11,9	19,5	145	17
5G1,5	1,5	0,8	1,1	12,7	13,3	170	23
5G2,5	2,0	0,9	1,3	15,3	7,98	240	32
5G4	2,5	1,0	1,4	17,9	4,95	350	42
5G6	3,0	1,0	1,6	20,0	3,30	475	54
5G10	4,0	1,2	2,3	25,9	1,91	775	75
5G16	5,0	1,2	2,5	30,0	1,21	1110	100

(*) also available without the green/yellow

N.B. Permissible current rating values are according to:

- three-phase circuit for three-core cables

CABLES FOR A MOVING WORLD

TRATOS[®] ENERGY DNOs

Tratos Utility cables are designed and tested to meet relevant UK, European and International standards. Manufactured in state of the art manufacturing facilities, the company's purpose-built, in-house Fire, Chemical, Electrical and Physical testing facilities and laboratories deliver peace of mind to customers ensuring their choice of Utility cable products meet all statutory and regulatory requirements.



www.tratosgroup.com



07BQ-F cable

TRATOS 07BQ-F

Reference Guide EN 50565:

They can be used both indoors and outdoors, in dry, damp or wet conditions. Suitable for heavy-duty uses and to power industrial and farm machinery. For connections undergoing moderate mechanical stresses, such as those in power tools (drills, circular saws, electrical home appliances) and heaters, as long as they do not touch hot parts and are not exposed to heat radiation. Avoid skin contact if they are used at high operating temperatures. Suitable to be used for fixed installations on temporary building fronts and workmen's shelter at work sites. Suitable up to 1000 V A.C. for fixed installations and duly shielded (in ducts and equipment). Not suitable for underground laying, even if shielded.

Reference Construction Products Regulation 305/2011 EU and Standard EN 50575:

The cable is suitable for the supply of electricity in buildings and other civil engineering works.

FEATURES AND PERFORMANCES

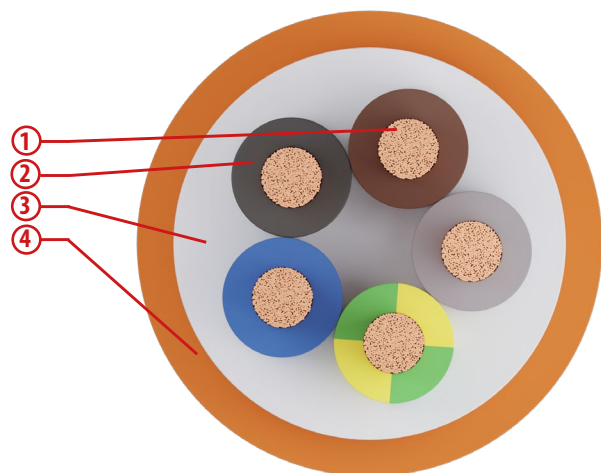

CONSTRUCTION

1. CLASS 5, FLEXIBLE, PLAIN COPPER WIRE
2. EPR RUBBER COMPOUND, QUALITY EI6 (THICKNESSES ACCORDING TO IEC 60502-1)
3. LS0H RUBBER, PENETRATING BETWEEN THE CORES (ONLY IN MULTI-CORE CABLES)
4. LS0H TMPU POLYURETHANE

LS0H = Low Smoke Zero Halogen

Structure and electrical, physical, mechanical requirements: EN 50525-2-21 IEC 60502-1

- Halogen free IEC 60754-1
- No corrosive gases IEC 60754-2
- Oil resistant according to EN 50363-10-2
EN 60811-404 (24 Std. / 100 °C)
- Low Voltage Directive 2014/35/EU
- RoHS Directive 2011/65/EU

Special features

Good resistance to mechanical stress and abrasion.
Good flexibility and behaviour at low temperatures.
Good resistance to UV (ISO 4892-2).
Absence of halogens. Sea water resistant.

Cable Marking

Tratos LTC 07BQ-F [form.] Eca [order number] [year] Made in Italy [metric]

Colours

- SINGLE-CORE 
- FOUR-CORE     or    
- FIVE-CORE      or     

The cores in multiple cables for signal and control are black, numbered, with or without GREEN/YELLOW

Installation conditions	
Minimum installation temperature	-40°C
Recommended min. bending radius	~6 times the cable diameter for mobile use, 4 times for static use
Recommended maximum tensile stress	15 N/mm ² of the cross-section of the copper for mobile use, 50 N/mm ² for static use

Functional characteristics	
Rated voltage: U ₀ /U	450/750 V (max 480/820 V a.c.) 560/1120 V (max 620/1240 V d.c.)
Max. operating temperature	90°C
Min. operating temperature	-60°C (without mechanical shocks)
Max. short circuit temperature	250°C

Single-core

Formation	Approx. conductor Ø	Average insulation thickness	Nominal external Ø	Max. electrical resistance at 20°C	Approx. cable weight	Current rating in air at 30°C	Voltage drop
n° x mm ²	mm	mm	mm	Ω/km	kg/km	A	V/A-Km
1 x 10	4,0	1,2	8,8	1,91	150	80	3,87
1 x 16	5,0	1,2	10,0	1,21	210	107	2,47
1 x 25	6,2	1,4	11,6	0,780	305	135	1,61
1 x 35	7,4	1,4	12,9	0,554	405	169	1,17
1 x 50	8,9	1,6	14,9	0,386	565	207	0,844
1 x 70	10,5	1,6	16,8	0,272	770	268	0,609
1 x 95	12,2	1,8	18,8	0,206	990	328	0,484
1 x 120	13,8	1,8	20,9	0,161	1240	383	0,388
1 x 150	15,4	2,0	22,9	0,129	1535	444	0,325
1 x 185	16,9	2,2	24,9	0,106	1860	510	0,279
1 x 240	19,5	2,4	28,0	0,0801	2405	607	0,221
1 x 300	21,6	2,6	30,8	0,0641	2990	703	0,184

N.B. Permissible current rating values are according to: - three-phase circuit

Four-core and five-core

Formation	Approx. conductor Ø	Average insulation thickness	Nominal external Ø	Max. electrical resistance at 20°C	Approx. cable weight	Current rating in air at 30°C	Voltage drop
n° x mm ²	mm	mm	mm	Ω/km	kg/km	A	V/A-Km
4G25	6,2	1,4	26,4	0,780	1450	127	1,61
4G35	7,4	1,4	30,0	0,554	1940	158	1,17
4G50	8,9	1,6	34,7	0,386	2690	192	0,844
4G70	10,5	1,6	39,1	0,272	3620	246	0,609
4G95	12,2	1,8	43,9	0,206	4680	298	0,484
5G25	6,2	1,4	29,8	0,780	1795	127	1,61
5G35	7,4	1,4	33,2	0,554	2360	158	1,17
5G50	8,9	1,6	38,4	0,386	3330	192	0,844
5G70	10,5	1,6	43,7	0,272	4450	246	0,609
5G95	12,2	1,8	48,7	0,206	5415	298	0,484

N.B. Permissible current rating values are according to: - three-phase circuit

Multi-core

Formation	Approx. conductor \emptyset	Average insulation thickness	Nominal external \emptyset	Max. electrical resistance at 20°C	Approx. cable weight	Current rating in air at 30°C	Voltage drop
n° x mm ²	mm	mm	mm	Ω /km	kg/km	A	V/A-Km
7G1,5	1,5	0,8	12,5	13,3	210	16	30,7
12G1,5	1,5	0,8	15,5	13,3	340	16	30,7
16G2,5	2,0	0,9	22,2	7,98	845	25	18,4

N.B. Permissible current rating values are according to:
- all conductors are charged (except for the green/yellow).

CABLES FOR A MOVING WORLD

TRATOS[®] ENERGY DNOs

Tratos Utility cables are designed and tested to meet relevant UK, European and International standards. Manufactured in state of the art manufacturing facilities, the company's purpose-built, in-house Fire, Chemical, Electrical and Physical testing facilities and laboratories deliver peace of mind to customers ensuring their choice of Utility cable products meet all statutory and regulatory requirements.



www.tratosgroup.com



S1BQ-F cable

TRATOS S1BQ-F

They can be used both indoors and outdoors, in dry, damp or wet conditions. Suitable for heavy-duty uses and to power industrial and farm machinery.

For connections undergoing moderate mechanical stresses, such as those in power tools (drills, circular saws, electrical home appliances) and heaters, as long as they do not touch hot parts and are not exposed to heat radiation. Avoid skin contact if they are used at high operating temperatures. Suitable to be used for fixed installations on temporary building fronts and workmen's shelter at work sites. Not suitable for underground laying, even if shielded.

Reference Construction Products Regulation 305/2011 EU and Standard EN 50575:

The cable is suitable for the supply of electricity in buildings and other civil engineering works.

FEATURES AND PERFORMANCES

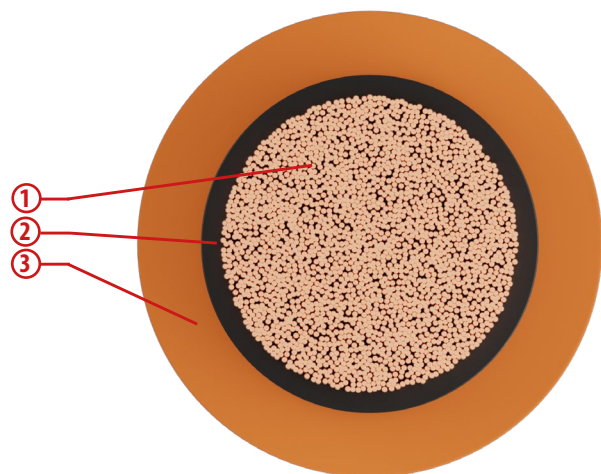

CONSTRUCTION

1. CLASS 5, FLEXIBLE, PLAIN COPPER WIRE
2. EPR RUBBER COMPOUND
3. LS0H TMPU POLYURETHANE
4. LS0H RUBBER, PENETRATING BETWEEN THE CORES (ONLY IN MULTI-CORE CABLES)

LS0H = Low Smoke Zero Halogen

Structure and electrical, physical, mechanical requirements: ref. to EN 50525-2-21 ref. to IEC 60502-1

- Low Voltage Directive 2014/35/EU
- RoHS Directive 2011/65/EU

Special features

Good resistance to mechanical stress and abrasion.
 Good flexibility and behaviour at low temperatures.
 Good resistance to UV (ISO 4892-2).
 Absence of halogens. Salt water resistant

Cable Marking

Tratos LTC S1BQ-F 1000V [form.] Eca [order number] [year] Made in Italy [metric]

Colours



The cores in multiple cables for signal and control are black, numbered, with or without GREEN/YELLOW

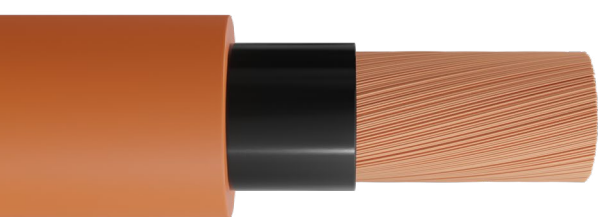

Functional characteristics	
Rated voltage: Uo/U	0,6/1 kV (max 0,7/1,2 kV a.c.) 0,7/1,5 kV (max 0,9/1,8 kV d.c.)
Max. operating temperature	90°C
Min. operating temperature	-60°C (without mechanical shocks)
Max. short circuit temperature	250°C

Installation conditions	
Minimum installation temperature	-40°C
Recommended min. bending radius	6 times the cable diameter for mobile use, 4 times for static use
Recommended maximum tensile stress	15 N/mm ² of the cross-section of the copper for mobile use, 50 N/mm ² for static use

Single-core

Formation	Approx. conductor \emptyset	Average insulation thickness	Approx. overall \emptyset	Max. electrical resistance at 20°C	Approx. cable weight	Current rating in air at 30°C
n° x mm ²	mm	mm	mm	Ω /km	kg/km	A
1 x 35	7,4	1,4	12,7	0,554	405	169
1 x 50	8,9	1,6	14,7	0,386	565	207
1 x 70	10,5	1,6	16,6	0,272	770	268
1 x 95	12,2	1,8	18,6	0,206	990	328
1 x 120	13,8	1,8	20,7	0,161	1240	383
1 x 150	15,4	2,0	22,7	0,129	1535	444
1 x 185	16,9	2,2	24,7	0,106	1860	510
1 x 240	19,5	2,4	27,7	0,0801	2405	607
1 x 300	21,6	2,6	30,9	0,0641	3085	703

N.B. Permissible current rating values are according to: - three conductors charged

Four-cores

Formation	Approx. conductor \emptyset	Average insulation thickness	Approx. overall \emptyset	Max. electrical resistance at 20°C	Approx. cable weight	Current rating in air at 30°C
n° x mm ²	mm	mm	mm	Ω /km	kg/km	A
4G35	5,0	1,2	29,8	1,21	900	158
4G50	8,9	2,9	34,3	0,386	2750	192
4G70	10,5	1,6	38,9	0,272	3805	246

N.B. Permissible current rating values are according to: - three conductors charged

Five cores

Formation	Approx. conductor \emptyset	Average insulation thickness	Approx. overall \emptyset	Max. electrical resistance at 20°C	Approx. cable weight	Current rating in air at 30°C
n° x mm ²	mm	mm	mm	Ω /km	kg/km	A
5G25	6,2	2,8	29,9	0,780	1845	127
5G35	7,4	2,9	33,0	0,554	2350	158
5G50	8,9	3,0	38,0	0,386	3285	192
5G70	10,5	3,3	43,5	0,272	4470	246
5G95	12,2	3,4	48,8	0,206	5725	298

N.B. Permissible current rating values are according to: - three conductors charged

H01N2-D cable

TRATOS H01N2-D

Reference Guide EN 50565:

For use on arc-welders as a link between a source of energy and the electrode support.

N.B. For applications not covered by Regulation EU 305/2011.

FEATURES AND PERFORMANCES

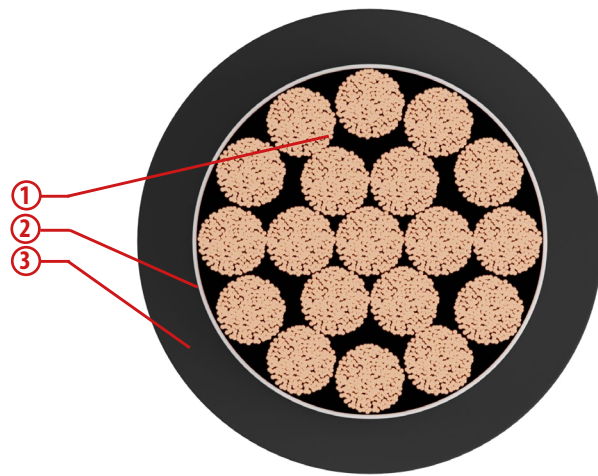

CONSTRUCTION

1. PLAIN COPPER WIRE, HIGHLY FLEXIBLE
2. TAPE
3. RUBBER COMPOUND

Structure and electrical, physical, mechanical requirements: EN 50525-2-81

- Flame propagation EN 60332-1-2
- Low Voltage Directive 2014/35/EU
- RoHS Directive 2011/65/EU

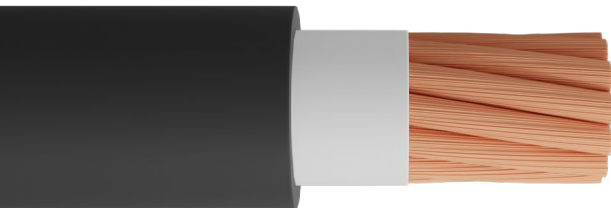

Special features

Good resistance to abrasion, atmospheric agents and ozone. Good resistance to constant flexing and bending.

Cable Marking

Tratos IEMMEQU [HAR] H01N2-D [form.] [order number] [year]

Installation conditions

Minimum installation temperature	-20°C
Recommended min. bending radius	6 times the cable diameter
Recommended maximum tensile stress	50 N/mm ² of the cross-section of the copper

Functional characteristics

Rated voltage: U _o /U	100/100 V
Max. operating temperature	85°C
Min. operating temperature	-35°C (without mechanical shocks)
Max. short circuit temperature	250°C

H01N2-D

Formation	Approx. conductor \emptyset	Average sheath thickness	Max. external \emptyset	Max. electrical resistance at 20°C	Approx. cable weight
n° x mm ²	mm	mm	mm	Ω /km	kg/km
1 x 10	4,2	2,0	9,7	1,91	145
1 x 16	5,3	2,0	11,0	1,21	200
1 x 25	6,2	2,0	12,7	0,780	290
1 x 35	7,7	2,0	14,2	0,554	380
1 x 50	9,0	2,2	16,5	0,386	525
1 x 70	10,7	2,4	19,2	0,272	730
1 x 95	12,8	2,6	21,4	0,206	940
1 x 120	15,0	2,8	24,0	0,161	1200
1 x 150	16,5	3,0	26,4	0,129	1475
1 x 185	16,9	3,2	28,9	0,106	1785

N.B. For current rating refer to table "Current carryings. Correction factors. Voltage drops"

Maximum diameter of wires in the conductor:

- cross-section $\leq 95 \text{ mm}^2 = 0,21 \text{ mm}$
- cross-section $\geq 185 \text{ mm}^2 = 0,51 \text{ mm}$

FS17-450/750 V cable

TRATOS FS17-450/750 V

Reference Guide CEI 20-40:

Fitted inside pipes or ducts, either visible or recessed, or similar closed system, but only inside buildings. Suitable for static, protected use inside lighting equipment or inside switching or control equipment, for alternating current up to 1000 V or direct current up to 750 V to ground. Suitable for bundle installations in environments at risk of fire. Not suitable for outside.

Reference Construction Products Regulation 305/2011 EU and Standard EN 50575:

Given its properties of limiting the development of fire and heat emission, the cable is suitable for the supply of electricity in buildings and other civil engineering works.

FEATURES AND PERFORMANCES

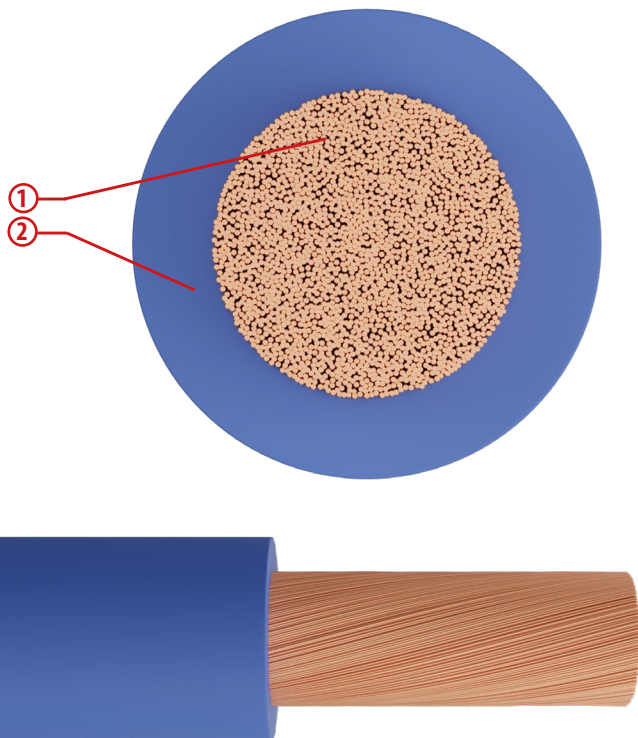

CONSTRUCTION

1. CLASS 5, FLEXIBLE, PLAIN COPPER WIRE
2. PVC, S17 QUALITY

Structure and electrical, physical, mechanical requirements: **CEI UNEL 35716**

- **Low Voltage Directive** 2014/35/EU
- **RoHS Directive** 2011/65/EU

Special features

Good sliding properties in pipes, good abrasion resistance, easy stripping.

Cable Marking

Tratos FS17 450/750 V [form.] Cca-s3,d1,a3 IEMMEQU EFP [year]

Installation conditions	
Minimum installation temperature	5°C
Recommended min. bending radius	4 times the cable diameter
Recommended maximum tensile stress	50 N/mm ² of the cross-section of the copper

Functional characteristics	
Rated voltage: U ₀ /U	450/750 V
Max voltage U	1000 in a.c.
Max. operating temperature	70°C
Min. operating temperature	-10°C (without mechanical shocks)
Max. short circuit temperature	160°C

FS17-450/750 V

Formation	Approx. conductor \emptyset	Average insulation thickness	Max. external \emptyset	Max. electrical resistance at 20°C	Approx. cable weight	Current rating in air at 30°C A	
						n° x mm ²	mm
1 x 1	1,3	0,7	3,0	19,5	14	12	-
1 x 1,5	1,5	0,7	3,4	13,3	19	15,5	-
1 x 2,5	2,0	0,8	4,1	7,98	30	21	-
1 x 4	2,5	0,8	4,8	4,95	45	28	-
1 x 6	3,0	0,8	5,3	3,30	64	36	-
1 x 10	4,0	1,0	6,8	1,91	110	50	57
1 x 16	5,0	1,0	8,7	1,21	160	68	76
1 x 25	6,2	1,2	10,2	0,780	250	89	101
1 x 35	7,4	1,2	11,7	0,554	340	110	125
1 x 50	8,9	1,4	13,9	0,386	485	134	151
1 x 70	10,5	1,4	16,0	0,272	675	171	192
1 x 95	12,2	1,6	18,2	0,206	890	207	232
1 x 120	13,8	1,6	20,2	0,161	1120	239	269
1 x 150	15,4	1,8	22,5	0,129	1390	275	309
1 x 185	16,9	2,0	24,9	0,106	1715	314	353
1 x 240	19,5	2,2	28,4	0,0801	2250	369	415

N.B. Permissible current rating values are according to three charged conductors.
In case of installation in environments with greater risk of fire, the values of the current rating must be multiplied by 0.8

FG17-450/750 V cable

TRATOS FG17-450/750 V

Reference Guidance CEI 20-40:

For environments where it is necessary to protect people: schools, offices, theatres, subways, hospitals, place of worship, malls and places of entertainment. Fitted inside pipes or ducts, either visible or recessed, or similar closed system. Suitable for static, protected use inside lighting equipment or inside switching or control equipment, for alternating current up to 1000 V or direct current up to 750 V to ground. Suitable for bundle installations in environments at risk of fire. Not suitable for outside use.

Reference Construction Products Regulation 305/2011 EU and Standard EN 50575:

Given its properties of limiting the development of fire, heat emission and noxious fumes, the cable is suitable for the supply of electricity in buildings and other civil engineering works.

FEATURES AND PERFORMANCES

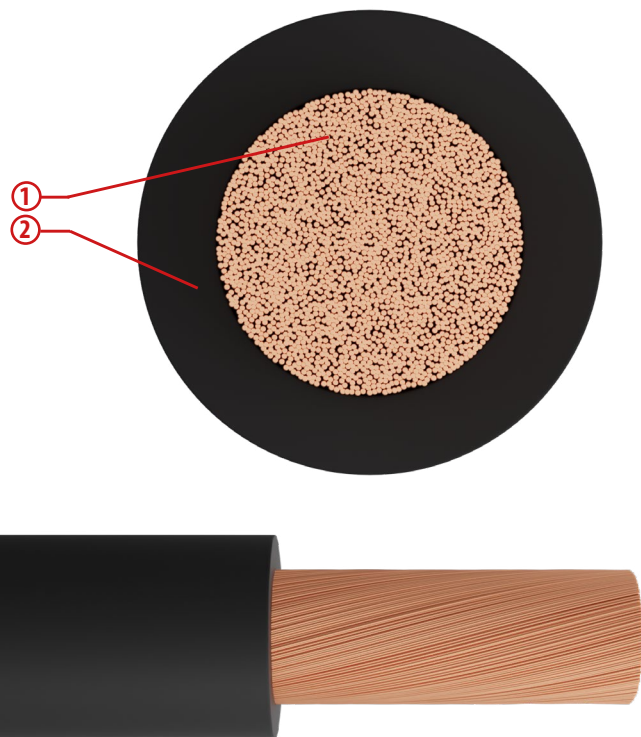

CONSTRUCTION

1. CLASS 5, FLEXIBLE, PLAIN COPPER WIRE
2. LS0H CROSS-LINKED ELASTOMERIC, G17 QUALITY

LS0H = Low Smoke Zero Halogen

Structure and electrical, physical, mechanical requirements: CEI UNEL 35310 CEI 20-38

- Corrosive gases or halogens EN 50267-2-1
- Low Voltage Directive 2014/35/EU
- RoHS Directive 2011/65/EU

Special features

Good sliding properties in pipes, good abrasion resistance, easy stripping.

Cable Marking

Tratos FG17 450/750 V Cca-s1b,d1,a1 [form.] IEMMEQU EFP [year]
[traceability]

Installation conditions	
Minimum installation temperature	-15°C
Recommended min. bending radius	4 times the cable diameter
Recommended maximum tensile stress	50 N/mm ² of the cross-section of the copper

Functional characteristics	
Rated voltage: U _o /U	450/750 V
Max. operating temperature	90°C
Min. operating temperature	-30°C (without mechanical shocks)
Max. short circuit temperature	160°C

FG17-450/750 V

Formation	Approx. conductor \emptyset	Average insulation thickness	Max. external \emptyset	Max. electrical resistance at 20°C	Approx. cable weight	Current rating in air at 30°C A	
						n° x mm ²	mm
1 x 1,5	1,5	0,7	3,4	13,30	20	20	24
1 x 2,5	2,0	0,8	4,1	7,98	30	28	33
1 x 4	2,5	0,8	4,8	4,95	45	37	45
1 x 6	3,0	0,8	5,3	3,30	65	48	58
1 x 10	3,9	1,0	6,8	1,91	105	66	80
1 x 16	5,0	1,0	8,7	1,21	160	88	107
1 x 25	6,2	1,2	10,2	0,780	245	117	141
1 x 35	7,3	1,2	11,7	0,554	330	144	176
1 x 50	8,8	1,4	13,9	0,386	475	175	216
1 x 70	10,5	1,4	16,0	0,272	660	222	279
1 x 95	12,0	1,6	18,2	0,206	865	269	342
1 x 120	12,9	1,6	20,2	0,161	1090	312	400
1 x 150	15,4	1,8	22,5	0,129	1355	355	464
1 x 185	16,9	2,0	24,9	0,106	1665	417	533
1 x 240	19,4	2,2	28,4	0,0801	2190	490	634
1 x 300 (*)	21,6	2,4	-	0,0641	2830	-	736

(*) = This formation is without IMQ certification

N.B. Permissible current rating values are according to three charged conductors.

In case of installation in environments with greater risk of fire, the values of the current rating must be multiplied by 0.8

FS18OR18-300/500 V cable

TRATOS FS18OR18-300/500 V

Reference Guidance CEI 20-40:

For applications, energy signalling and control, in fixed installation. Thanks to its flexibility the cable is also suitable for ordinary service handling and manipulation as well as outdoor laying for short periods. Suitable in small spaces, it can also be used in bundle laying. Can be laid indoor in normal or humid environments and temporarily outside.

Underground installation is not permitted even if protected.

Reference Construction Products Regulation 305/2011 EU and Standard EN 50575:

The cables are suitable for the supply of electricity in buildings and other civil engineering works.

FEATURES AND PERFORMANCES

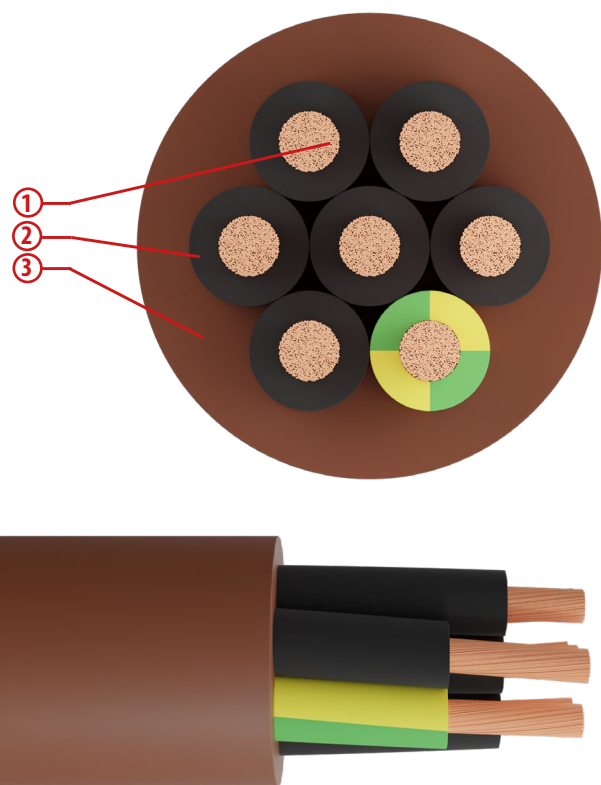

CONSTRUCTION

1. CLASS 5, FLEXIBLE, PLAIN COPPER WIRE
2. PVC, S18 QUALITY
3. PVC, R18 QUALITY

Structure and electrical, physical, mechanical requirements: CEI UNEL 35720 EN 50525-1 CEI 20-11/0-1 V2 (EN 50363-0)

- Corrosive gases or halogens EN 50267-2-1
- Low Voltage Directive 2014/35/EU
- RoHS Directive 2011/65/EU

Special features

Good resistance to mechanical shock and chemical agents. Good flexibility and behaviour at low temperatures.

Cable Marking

Made in Italy Tratos FS18OR18-300/500V [form.] Cca-s3,d1,a3 IEM-MEQU EFP [year] [traceability] [metric]

Colours

- TWO-CORE
- THREE-CORE
- FOUR-CORE
- FIVE-CORE

The cores in multiple cables for signal and control are black, numbered, with or without GREEN/YELLOW

Installation conditions

Minimum installation temperature	0°C
Recommended min. bending radius	4 times the cable diameter
Recommended maximum tensile stress	50 N/mm ² of the cross-section of the copper

Functional characteristics

Rated voltage: U ₀ /U	300/500 V
Max. operating temperature	70°C
Min. operating temperature	-15°C (without mechanical shocks)
Max. short circuit temperature	160°C

FS18OR18-300/500 V

Formation	Approx. conductor \emptyset	Average insulation thickness	Average sheath thickness	Max. external \emptyset	Max. electrical resistance at 20°C	Approx. cable weight	Current rating in air at 30°C A	
							n° x mm ²	mm
2 x 0,5	0,9	0,4	0,7	5,7	39,0	31	7,5	10
2 x 0,75	1,1	0,4	0,7	6,0	26,0	39	9,5	13
2 x 1	1,3	0,4	0,7	6,4	19,5	46	13,5	15
3G0,5	0,9	0,4	0,7	6,0	39,0	37	7,5	10
3G0,75	1,1	0,4	0,7	6,4	26,0	46	9,5	13
3G1	1,3	0,4	0,7	6,8	19,5	56	13,5	15
4G0,5	0,9	0,4	0,7	6,5	39,0	45	6,5	9
4G0,75	1,1	0,4	0,7	7,0	26,0	56	8	11
4G1	1,3	0,4	0,8	7,6	19,5	71	12	13,6
5G0,5	0,9	0,4	0,7	7,1	39,0	55	6,5	9
5G0,75	1,1	0,4	0,8	7,8	26,0	72	8	11
5G1	1,3	0,4	0,8	8,3	19,5	87	12	13,6

Permissible current rating values are according to:

- two-phase circuit for two-core cables
- three-phase circuit for three-core, four-core and five-core cables

FS18OR18-300/500 V / signalling and control

Formation	Approx. conductor Ø	Average insulation thickness	Average sheath thickness	Max. external Ø	Max. electrical resistance at 20°C	Approx. cable weight	Current rating in air at 30°C A	
							n° x mm ²	mm
7G0,5	0,9	0,4	0,9	7,9	39,0	70	6	7
10G0,5	0,9	0,4	1,0	10,2	39,4	100	5	6
12G0,5	0,9	0,4	1,0	10,5	39,4	115	5	5,5
14G0,5	0,9	0,4	1,1	11,3	39,4	135	4,5	5
16G0,5	0,9	0,4	1,1	11,9	39,4	150	4,5	5
19G0,5	0,9	0,4	1,1	12,5	39,4	170	4	4,5
24G0,5	0,9	0,4	1,3	15,0	39,6	225	3,5	4
27G0,5	0,9	0,4	1,3	15,3	39,6	245	3,5	4
7G0,75	1,1	0,4	0,8	8,5	26,0	89	7,5	8,5
10G0,75	1,1	0,4	1,0	11,1	26,3	130	6,5	7,5
12G0,75	1,1	0,4	1,0	11,5	26,3	150	6	7
14G0,75	1,1	0,4	1,0	12,0	26,3	170	5,5	6,5
16G0,75	1,1	0,4	1,1	12,9	26,3	200	5,5	6,5
19G0,75	1,1	0,4	1,1	13,6	26,3	225	5	6
24G0,75	1,1	0,4	1,3	16,2	26,4	285	5	5,5
27G0,75	1,1	0,4	1,3	16,6	26,4	320	5	5,5
7G1	1,3	0,4	0,9	9,2	19,5	110	9	10
10G1	1,3	0,4	1,0	11,8	19,7	160	8,5	9,5
12G1	1,3	0,4	1,0	12,2	19,7	180	8	9,5
14G1	1,3	0,4	1,1	13,0	19,7	215	8	9
16G1	1,3	0,4	1,1	13,7	19,7	240	7	8
19G1	1,3	0,4	1,2	14,7	19,7	280	7	7,5
24G1	1,3	0,4	1,3	17,3	19,8	355	6,5	7
27G1	1,3	0,4	1,3	17,6	19,8	395	5,5	6,5
7G1,5	1,5	0,4	0,9	10,1	13,3	150	11,5	13
10G1,5	1,5	0,4	1,1	13,2	13,4	215	10,5	12
12G1,5	1,5	0,4	1,1	13,7	13,4	250	9,5	11
14G1,5	1,5	0,4	1,2	14,5	13,4	295	9	10
16G1,5	1,5	0,4	1,2	15,3	13,4	330	9	10
19G1,5	1,5	0,4	1,3	16,4	13,4	390	8,5	9,5
24G1,5	1,5	0,4	1,5	19,5	13,5	490	8	9
27G1,5	1,5	0,4	1,5	19,9	13,5	550	7	8
7G2,5	2,0	0,5	1,1	12,8	7,98	240	16,5	18,5
10G2,5	2,0	0,5	1,3	16,7	8,06	340	14,5	16
12G2,5	2,0	0,5	1,3	17,3	8,06	400	13,5	15
14G2,5	2,0	0,5	1,4	18,3	8,06	470	13	14,5
16G2,5	2,0	0,5	1,5	19,6	8,06	540	12	13,5
19G2,5	2,0	0,5	1,5	20,6	8,06	615	11	12,5
24G2,5	2,0	0,5	1,7	24,5	8,1	780	10,5	12
27G2,5	2,0	0,5	1,8	25,2	8,1	880	10	11,5

N.B. Permissible current rating values refer to all conductors are charged (except for the green/yellow).

C A B L E S F O R A M O V I N G W O R L D

TRATOS[®] ENERGY DNOs

Tratos Utility cables are designed and tested to meet relevant UK, European and International standards. Manufactured in state of the art manufacturing facilities, the company's purpose-built, in-house Fire, Chemical, Electrical and Physical testing facilities and laboratories deliver peace of mind to customers ensuring their choice of Utility cable products meet all statutory and regulatory requirements.



www.tratosgroup.com



TRATOS General Cables®

FS18OR18-450/750 V cable

TRATOS FS18OR18-450/750 V

Reference Guidance CEI 20-40:

For applications, energy signalling and control, in fixed installation. Thanks to its flexibility the cable is also suitable for ordinary service handling and manipulation as well as outdoor laying for short periods. Suitable in small spaces, it can also be used in bundle laying. Can be laid indoor in normal or humid environments and temporarily outside.

Underground installation is not permitted even if protected.

Reference Construction Products Regulation 305/2011 EU and Standard EN 50575:

The cables are suitable for the supply of electricity in buildings and other civil engineering works.

FEATURES AND PERFORMANCES

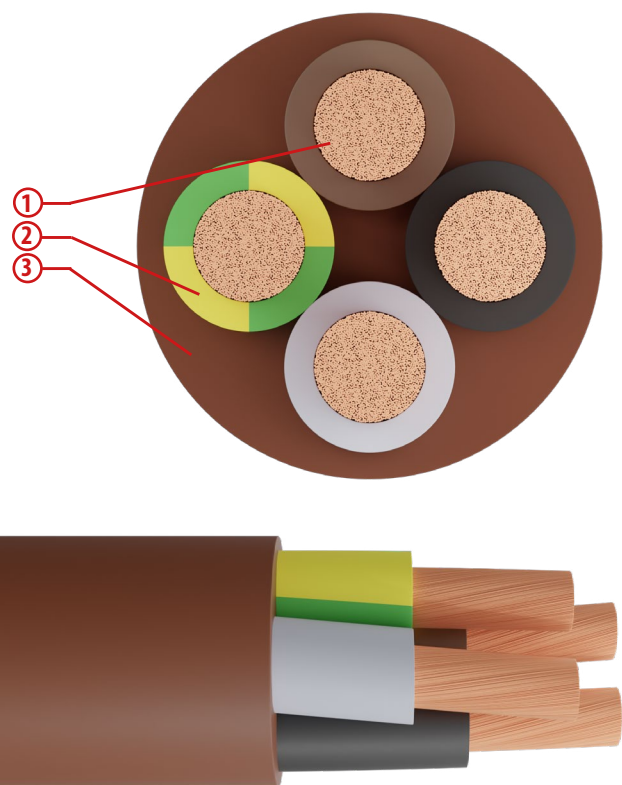

CONSTRUCTION

1. CLASS 5, FLEXIBLE, PLAIN COPPER WIRE
2. PVC, S18 QUALITY
3. PVC, R18 QUALITY

Structure and electrical, physical, mechanical requirements: CEI UNEL 35720 EN 50525-1 CEI 20-11/0-1 V2 (EN 50363-0)

- Corrosive gases or halogens EN 50267-2-1
- Low Voltage Directive 2014/35/EU
- RoHS Directive 2011/65/EU







Special features

Good resistance to mechanical shock and chemical agents. Good flexibility and behaviour at low temperatures.

Cable Marking

Made in Italy Tratos FS18OR18-450/750V [form.] Cca-s3,d1,a3 IEM-MEQU EFP [year] [traceability] [metric]

Colours

- TWO-CORE 
- THREE-CORE  or 
- FOUR-CORE  or 
- FIVE-CORE  or 

Installation conditions	
Minimum installation temperature	0°C
Recommended min. bending radius	4 times the cable diameter
Recommended maximum tensile stress	50 N/mm ² of the cross-section of the copper

Functional characteristics	
Rated voltage: U ₀ /U	450/750 V
Max. operating temperature	70°C
Min. operating temperature	-15°C (without mechanical shocks)
Max. short circuit temperature	160°C

FS18OR18-450/750 V

Formation	Approx. conductor \emptyset	Average insulation thickness	Average sheath thickness	Max. external \emptyset	Max. electrical resistance at 20°C	Approx. cable weight	Current rating in air at 30°C A	
							n° x mm ²	mm
2 x 1,5	1,5	0,4	1,0	8,0	13,3	62	16,5	22
2 x 2,5	2,0	0,5	1,0	9,5	7,98	93	23	30
3G1,5	1,5	0,4	1,0	8,5	13,3	76	16,5	22
3G2,5	2,0	0,5	1,1	10,4	7,98	120	23	30
4G1,5	1,5	0,4	1,0	9,5	13,3	94	15	18,5
4G2,5	2,0	0,5	1,1	11,3	7,98	150	20	25
5G1,5	1,5	0,4	1,1	10,2	13,3	120	15	18,5
5G2,5	2,0	0,5	1,2	12,5	7,98	185	20	25

Permissible current rating values are according to:

- two-phase circuit for two-core cables
- three-phase circuit for three-core, four-core and five-core cables

FLEX-OIL PLUS-450/750 V cable

TRATOS FLEX-OIL PLUS-450/750 V

For use in dry, humid or wet environments subject to moderate mechanical loads. Can be used outdoors. Suitable for the connection of machine tools, control equipment and assembly lines, adjustment and measuring instruments and computer units. Suitable for both static and mobile installations even in the presence of residues of industrial oils as long as the cable is not highly tensioned.

Reference Construction Products Regulation 305/2011 EU and Standard EN 50575:

The cable is suitable for the supply of electricity in buildings and other civil engineering works.

FEATURES AND PERFORMANCES

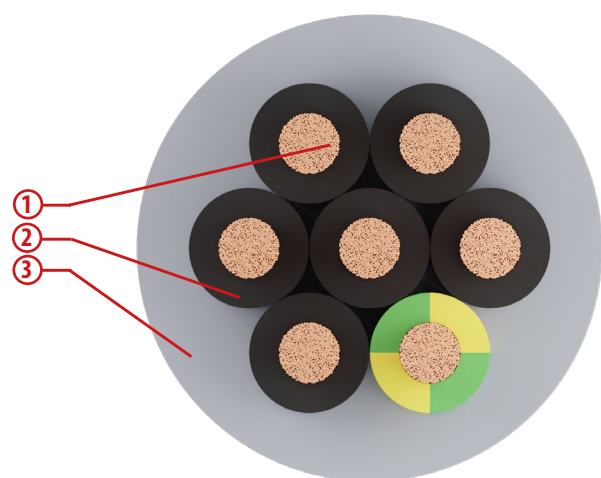

CONSTRUCTION

1. CLASS 5, FLEXIBLE, PLAIN COPPER WIRE
2. PVC, TI2 QUALITY
3. PVC, TM2 QUALITY

Structure and electrical, physical, mechanical requirements: EN 50525-1

- Corrosive gases or halogens EN 50267-2-1
- Oil, acids and bases resistance CEI 20-34/0-1
- Low Voltage Directive 2014/35/EU
- RoHS Directive 2011/65/EU

Special features

At ambient temperature, good resistance to chemicals such as alkalis, acids and mineral oils (CEI 20-34/0-1; 4 h / 70°C, olio IRM 902). In addition, the PVC sheath has good characteristics of non-hygroscopicity (EN 60811-402) and resistance to UV rays (EN 50289-4-17).

Cable Marking

Tratos FLEX-OIL PLUS 450/750V [form.] Eca - O.R. CEI 20-34 - FLAME RETARDANT CEI EN 60332-1-2 [traceability] [year] [metric]

Installation conditions	
Minimum installation temperature	-5°C
Recommended min. bending radius	10 times of the cable diameter for mobile use, 4 times for static use
Recommended maximum tensile stress	15 N/mm ² of the cross-section of the copper for mobile use, 50 N/mm ² for static use

Functional characteristics	
Rated voltage: Uo/U	450/750 V
Max. operating temperature	60°C
Min. operating temperature	-40°C (under static conditions and without mechanical stress; during laying, the minimum bending radius must be ≥ 10 times the diameter of the cable)
Max. short circuit temperature	150°C

Colours

- TWO-CORE or
- THREE-CORE or
- FOUR-CORE or
- FIVE-CORE

The cores in multiple cables for signal and control are black, numbered, with or without GREEN/YELLOW

FLEX-OIL PLUS-450/750 V

Formation	Approx. conductor \emptyset	Average insulation thickness	Average sheath thickness	Approx. external \emptyset	Max. electrical resistance at 20°C	Approx. cable weight	Current rating in air at 30°C
n° x mm ²	mm	mm	mm	mm	Ω /km	kg/km	A
2 x 0,75	1,1	0,4	0,7	4,9	26,0	39	6
2 x 1	1,3	0,4	0,7	5,2	19,50	46	10
2 x 1,5	1,5	0,4	0,8	6,0	13,30	63	16
2 x 2,5	2,0	0,5	0,8	7,2	7,98	95	25
3G0,5	0,9	0,4	0,7	4,8	39,0	37	3
3G0,75	1,1	0,4	0,7	5,2	26,0	47	6
3G1	1,3	0,4	0,7	5,5	19,5	57	10
3G1,5	1,5	0,4	0,8	6,4	13,30	78	16
3G2,5	2,0	0,5	0,9	7,9	7,98	120	20
3G4	2,5	0,5	1,0	9,0	4,95	175	25
3G6	3,0	0,6	1,1	11,0	3,30	260	40
4G0,5	0,9	0,4	0,7	5,2	39,0	45	3
4G0,75	1,1	0,4	0,7	5,7	26,0	57	6
4G1	1,3	0,4	0,8	6,2	19,5	73	10
4G1,5	1,5	0,4	0,8	6,9	13,30	96	16
4G2,5	2,0	0,5	0,9	8,6	7,98	150	20
4G4	2,5	0,5	1,0	10,0	4,95	220	25
4G6	3,0	0,6	1,2	12,3	3,30	330	35
5G0,5	0,9	0,4	0,7	5,6	39,0	55	3
5G0,75	1,1	0,4	0,8	6,4	26,0	74	6
5G1	1,3	0,4	0,8	6,8	19,5	88	10
5G1,5	1,5	0,4	0,9	7,8	13,30	120	16
5G2,5	2,0	0,5	1,0	9,6	7,98	190	20
5G4	2,5	0,5	1,1	11,2	4,95	280	25
5G6	3,0	0,6	1,3	13,6	3,30	420	35
6G0,75	1,1	0,4	0,8	6,9	26,0	68	4
7G0,5	0,9	0,4	0,8	6,3	39,0	71	2
7G0,75	1,1	0,4	0,8	6,9	26,0	92	4
7G1	1,3	0,4	0,9	7,6	19,50	115	7
7G1,5	1,5	0,4	0,9	8,5	13,30	155	11
7G2,5	2,0	0,5	1,1	10,7	7,98	250	14
7G4	2,5	0,5	1,2	12,4	4,95	365	17
7G6	3,0	0,6	1,4	15,0	3,30	540	24
8G0,5	0,9	0,4	0,9	7,6	39,0	94	2
8G1	1,3	0,4	1,0	9,0	19,50	150	7
9G0,75	1,1	0,4	1,0	9,1	26,0	140	4

TRATOS General Cables®

Formation	Approx. conductor \emptyset	Average insulation thickness	Average sheath thickness	Approx. external \emptyset	Max. electrical resistance at 20°C	Approx. cable weight	Current rating in air at 30°C
n° x mm ²	mm	mm	mm	mm	Ω /km	kg/km	A
10G0,5	0,9	0,4	0,9	7,6	39,0	100	2
10G0,75	1,1	0,4	1,0	8,5	26,0	130	4
10G1	1,3	0,4	1,0	9,0	19,50	160	7
10G1,5	1,5	0,4	1,1	10,3	13,30	220	11
10G2,5	2,0	0,5	1,3	12,9	7,98	350	14
12G0,5	0,9	0,4	0,9	8,1	39,50	115	1,5
12G0,75	1,1	0,4	1,0	9,1	26,30	150	3
12G1	1,3	0,4	1,0	9,7	19,70	190	5
12G1,5	1,5	0,4	1,1	11,1	13,40	255	9
12G2,5	2,0	0,5	1,3	13,9	8,06	410	11
14G0,5	0,9	0,4	1,0	9,0	39,50	135	1,5
14G0,75	1,1	0,4	1,0	9,9	26,30	175	3
14G1	1,3	0,4	1,1	10,7	19,70	220	5
14G1,5	1,5	0,4	1,2	12,2	13,40	300	9
14G2,5	2,0	0,5	1,4		8,06		11
16G0,5	0,9	0,4	1,0	9,4	39,50	155	1,5
16G0,75	1,1	0,4	1,1	10,6	26,30	205	3
16G1	1,3	0,4	1,1	11,3	19,70	250	5
16G1,5	1,5	0,4	1,2	12,9	13,40	340	9
16G2,5	2,0	0,5	1,5	16,8	8,06		11
17G1,5	1,5	0,4	1,3	13,8	13,40	375	9
18G0,5	0,9	0,4	1,0	9,9	39,5	170	1,5
18G0,75	1,1	0,4	1,1	11,1	26,3	230	3
18G1	1,3	0,4	1,2	12,1	19,7	285	5
18G1,5	1,5	0,4	1,3	13,8	13,4	385	9
18G2,5	2,0	0,5	1,5	17,7	8,06	600	11

Formation	Approx. conductor \emptyset	Average insulation thickness	Average sheath thickness	Approx. external \emptyset	Max. electrical resistance at 20°C	Approx. cable weight	Current rating in air at 30°C
n° x mm ²	mm	mm	mm	mm	Ω /km	kg/km	A
19G0,5	0,9	0,4	1,0	10,4	39,50	175	1,5
19G0,75	1,1	0,4	1,1	11,7	26,30	230	3
19G1	1,3	0,4	1,2	12,6	19,70	290	5
19G1,5	1,5	0,4	1,3	14,1	13,40	396	8
19G2,5	2,0	0,4	1,5	17,7	8,06	630	10
20G1	1,3	0,4	1,2	13,1	19,70	315	5
25G0,5	0,9	0,4	1,2	12,0	39,80	230	1,3
25G0,75	1,1	0,4	1,3	13,3	26,60	305	2,5
25G1	1,3	0,4	1,3	14,2	19,80	375	4
25G1,5	1,5	0,4	1,5	16,3	13,50	520	7
26G1	1,3	0,4	1,3	14,5	19,80	400	4
26G1,5	1,5	0,4	1,5	16,7	13,50	550	7
30G1,5	1,5	0,4	1,5	17,3	13,50	615	7
31G0,5	0,9	0,4	1,3	13,2	39,80	295	1,3
32G0,5	0,9	0,4	1,3	13,2	39,80	300	1,3
34G1	1,3	0,4	1,5	16,0	19,80	510	4
34G1,5	1,5	0,4	1,6	18,2	13,50	695	7
37G0,5	0,9	0,4	1,3	13,7	39,80	330	1
37G1	1,3	0,4	1,5	16,6	19,80	545	3
37G1,5	1,5	0,4	1,6	18,9	13,50	750	5
40G0,5	0,9	0,4	1,3	14,2	39,80	360	1
40G1	1,3	0,4	1,5	17,2	19,80	600	3
40G1,5	1,5	0,4	1,7	19,8	13,50	825	5
41G1	1,3	0,4	1,6	18,1	19,8	630	3
50G0,5	0,9	0,4	1,5	15,8	39,80	440	1
50G0,75	1,1	0,4	1,6	17,6	26,6	590	2
50G1	1,3	0,4	1,7	19,0	19,80	735	3
50G1,5	1,5	0,4	1,9	21,8	13,5	1015	5
52G0,5	0,9	0,4	1,5	16,0	39,80	460	1
52G1	1,3	0,4	1,7	19,2	19,80	760	3
60G0,5	0,9	0,4	1,6	18,0	39,80	530	1
61G1	1,3	0,4	1,8	21,1	19,80	885	3
64G1	1,3	0,4	1,8	21,7	19,80	930	3
65G0,75	1,1	0,4	1,8	20,3	26,60	765	2
65G1	1,3	0,4	1,8	21,7	19,80	955	3
80G0,75	1,1	0,4	1,9	22,5	26,60	925	2

TRATOS General Cables®

FLEX-OIL PLUS SCH.-450/750 V cable

TRATOS FLEX-OIL PLUS SCH.-450/750 V

For use in dry, humid or wet environments subject to moderate mechanical loads. Can be used outdoors only if protected from UV radiation. Suitable for the connection of machine tools, control equipment and assembly lines, adjustment and measuring instruments and computer units. Suitable for both static and mobile installations even in the presence of residues of industrial oils as long as the cable is not highly tensioned. The screen offers protection from electromagnetic interference.

Reference Construction Products Regulation 305/2011 EU and Standard EN 50575:
The cable is suitable for the supply of electricity in buildings and other civil engineering works.

FEATURES AND PERFORMANCES

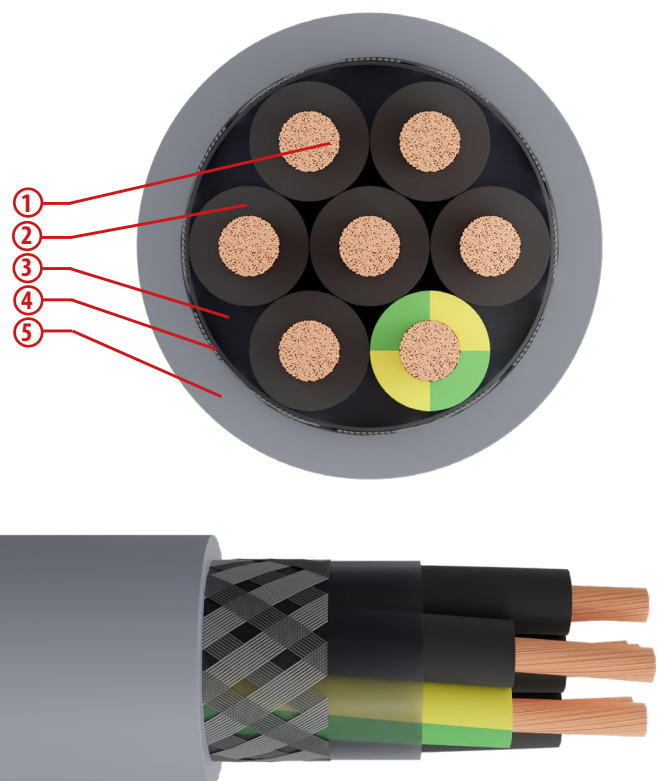

CONSTRUCTION

1. CLASS 5, FLEXIBLE, PLAIN COPPER WIRE
2. SPECIAL PVC
3. POLYESTER FOIL
4. TINNED COPPER BRAID
5. PVC, TM2 QUALITY

Structure and electrical, physical, mechanical requirements: EN 50525-1

- Corrosive gases or halogens EN 50267-2-1
- Oil, acids and bases resistance CEI 20-34
- Low Voltage Directive 2014/35/EU
- RoHS Directive 2011/65/EU

Cable Marking

Tratos FLEX-OIL PLUS 450/750V [form.] Eca - O.R. CEI 20-34 - FLAME RETARDANT CEI EN 60332-1-2 [traceability] [year] [metric]

Installation conditions	
Minimum installation temperature	-5°C
Recommended min. bending radius	8 times of the cable diameter
Recommended maximum tensile stress	50 N/mm ² of the cross-section of the copper

Functional characteristics	
Rated voltage: U _o /U	450/750 V
Max. operating temperature	60°C
Min. operating temperature	-20°C (without mechanical shocks)
Max. short circuit temperature	150°C

Colours

- TWO-CORE
- THREE-CORE
- FOUR-CORE
- FIVE-CORE

The cores in multiple cables for signal and control are black, numbered, with or without GREEN/YELLOW

Flex-Oil plus sch.

Formation	Approx. conductor \emptyset	Average insulation thickness	Average sheath thickness	Approx. external \emptyset	Max. electrical resistance at 20°C	Approx. cable weight
$n^\circ \times \text{mm}^2$	mm	mm	mm	mm	Ω/km	kg/km
2 x 0,5	0,9	0,4	0,8	5,6	39,0	39
2 x 1	1,3	0,4	0,8	6,3	19,50	54
2 x 1,5	1,5	0,4	0,9	7,1	13,30	70
3G0,5	0,9	0,4	0,8	5,9	39,0	48
3G1	1,3	0,4	0,8	6,6	19,5	67
3G1,5	1,5	0,4	0,9	7,5	13,30	88
3G4	2,5	0,5	1,1	10,3	4,95	185
4G0,5	0,9	0,4	0,8	6,3	39,0	57
4G1	1,3	0,4	0,8	7,2	19,5	82
4G1,5	1,5	0,4	0,9	8,1	13,30	110
4G2,5	2,0	0,5	1,0	9,7	7,98	160
4G4	2,5	0,5	1,1	11,3	4,95	230
4G6	3,0	0,6	1,3	13,8	3,30	340

Flex-Oil plus sch.

Formation	Approx. conductor \emptyset	Average insulation thickness	Average sheath thickness	Approx. external \emptyset	Max. electrical resistance at 20°C	Approx. cable weight
$n^\circ \times \text{mm}^2$	mm	mm	mm	mm	Ω/km	kg/km
5G0,5	0,9	0,4	0,8	6,8	39,0	68
5G1	1,3	0,4	0,9	8,0	19,50	100
5G1,5	1,5	0,4	1,0	9,0	13,30	135
7G0,5	0,9	0,4	0,9	7,5	39,0	85
7G1	1,3	0,4	0,9	8,6	19,50	125
7G1,5	1,5	0,4	1,0	9,7	13,30	170
7G2,5	2,0	0,5	1,2	12,0	7,98	270
8G0,5	0,9	0,4	0,9	8,6	39,0	110
12G0,5	0,9	0,4	1,0	9,3	39,50	135
12G1	1,3	0,4	1,1	10,9	19,70	210
12G1,5	1,5	0,4	1,2	12,3	13,40	285
18G0,5	0,9	0,4	1,1	11,2	39,50	190
18G1	1,3	0,4	1,3	13,3	19,70	315
18G1,5	1,5	0,4	1,4	15,2	13,40	460
25G0,5	0,9	0,4	1,3	12,9	39,8	265
25G1	1,3	0,4	1,4	15,3	19,8	430
25G1,5	1,5	0,4	1,6	17,4	13,5	575

TRATOS General Cables®

FG16R16-0,6/1 kV | FG16OR16-0,6/1 kV cable

TRATOS FG16R16-0,6/1 kV TRATOS FG16OR16-0,6/1 kV

Reference Guidance CEI 20-67:

Cable suitable for energy supply in industry, building sites and construction industry. For fixed wiring indoors and outdoors, even wet (AD7); for direct and indirect underground wiring. Suitable for installation at open air, on walls, metal structures, cable trays, pipes, wiring holders and similar devices. Suitable for bundle installations in environments at risk of fire.

Reference Construction Products Regulation 305/2011 EU and Standard EN 50575:

Given its properties of limiting the development of fire and heat emission, the cable is suitable for the supply of electricity in buildings and other civil engineering works.

FEATURES AND PERFORMANCES

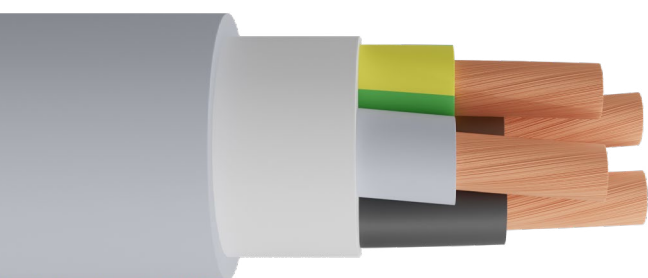
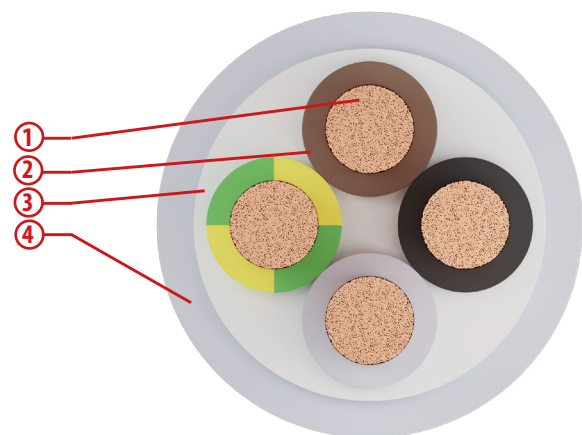

CONSTRUCTION

1. CLASS 5, FLEXIBLE, PLAIN COPPER WIRE
2. RUBBER COMPOUND, G16 QUALITY
3. THERMOPLASTIC, PENETRATING BETWEEN THE CORES (ONLY IN MULTI-CORE CABLES)
4. PVC, R16 QUALITY

Structure and electrical, physical, mechanical requirements: CEI 20-13 IEC 60502-1 EI UNEL 35318 (energy)
CEI UNEL 35322 (control)

- Low Voltage Directive 2014/35/EU
- RoHS Directive 2011/65/EU

Special features

Good resistance to grease and mineral oils. Good flexibility and behaviour at low temperatures. UV resistance.

Cable Marking

Tratos FG16(O)R16 0,6/1 kV [form.] Cca-s3,d1,a3 IEMMEQU EFP
[year] [traceability] [metric]
Tratos FG16(O)R16 0,6/1 kV [form.] Cca-s3,d1,a3 [year] [traceability]
[metric]

Colours

- SINGLE-CORE ●
- TWO-CORE ● ●
- THREE-CORE ● ● ● or ● ● ●
- FOUR-CORE ● ● ● ● or ● ● ● ●
- FIVE-CORE ● ● ● ● ● or ● ● ● ● ●

The cores in multiple cables for signal and control are black, numbered, with or without GREEN/YELLOW

Installation conditions	
Minimum installation temperature	0°C
Recommended min. bending radius	4 times the cable diameter
Recommended maximum tensile stress	50 N/mm ² of the cross-section of the copper

Functional characteristics	
Rated voltage: U ₀ /U	600/1000 V a.c. 1500 V d.c.
Max. rated voltage U _m	1200 V a.c. 1800 V d.c. also earthwards
Voltage test	4000 V
Max. operating temperature	90°C
Min. operating temperature	-15°C (without mechanical shocks)
Max. short circuit temperature	250°C

Single-core

Formation	Approx. conductor Ø	Average insulation thickness	Average sheath thickness	Max. external Ø	Max. electrical resistance at 20°C	Approx. cable weight	Current rating A					
							in air a 30°C	in pipe in air at 30°C	buried at 20°C		buried pipe at 20°C	
									K = 1	K = 1,5	K = 1	K = 1,5
1 x 1,5	1,5	0,7	1,4	8,2	13,3	55	24	20	26	24	23	21
1 x 2,5	2,0	0,7	1,4	8,7	7,98	69	33	28	34	31	29	27
1 x 4	2,5	0,7	1,4	9,3	4,95	84	45	37	43	40	38	35
1 x 6	3,0	0,7	1,4	9,9	3,30	115	58	48	55	51	48	44
1 x 10	4,0	0,7	1,4	10,9	1,91	155	80	66	73	68	64	59
1 x 16	5,0	0,7	1,4	11,4	1,21	225	107	88	96	89	83	77
1 x 25	6,2	0,9	1,4	13,2	0,780	320	141	117	124	115	108	100
1 x 35	7,4	0,9	1,4	14,6	0,554	420	176	144	150	139	131	121
1 x 50	8,9	1,0	1,4	16,4	0,386	585	216	175	186	173	162	150
1 x 70	10,5	1,1	1,4	18,3	0,272	790	279	222	229	212	199	184
1 x 95	12,2	1,1	1,5	20,4	0,206	990	342	269	270	250	234	217
1 x 120	13,8	1,2	1,5	22,4	0,161	1020	400	312	312	289	271	251
1 x 150	15,4	1,4	1,6	24,8	0,129	1550	464	355	356	330	310	287
1 x 185	16,9	1,6	1,6	27,2	0,106	1870	533	417	401	371	349	323
1 x 240	19,5	1,7	1,7	30,4	0,0801	2400	634	490	471	436	409	379
1 x 300	23,0	1,8	1,8	33,0	0,0641	2955	736	-	533	493	463	429
1 x 400	26,5	2,0	1,9	37,7	0,0486	3835	868	-	621	575	540	500
1 x 500 (*)	28,5	2,2	2,1	45,0	0,0384	4785	998	-	689	650	599	565
1 x 630 (*)	32,8	2,4	2,3	51,1	0,0287	6465	1151	-	785	741	683	645

(*) = This formation is not part of the CEI UNEL
 Permissible current rating values are according to:
 - three-phase circuit
 - laying depth of 0,8 m for buried cables

N.B. K=1: resistivity of the ground equal to 1,0 K-m/W
 K=1,5: resistivity of the ground equal to 1,5 K-m/W

Two-core

Formation	Approx. conductor Ø	Average insulation thickness	Average sheath thickness	Max. external Ø	Max. electrical resistance at 20°C	Approx. cable weight	Current rating A					
							in air a 30°C	in pipe in air at 30°C	buried at 20°C		buried pipe at 20°C	
									K = 1	K = 1,5	K = 1	K = 1,5
n° x mm²	mm	mm	mm	mm	Ω/km	kg/km						
2 x 1,5	1,5	0,7	1,8	12,0	13,3	130	26	22	28	26	25	23
2 x 2,5	2,0	0,7	1,8	13,0	7,98	165	36	30	37	35	32	30
2 x 4	2,5	0,7	1,8	14,2	4,95	210	49	40	48	45	41	39
2 x 6	3,0	0,7	1,8	15,4	3,30	270	63	51	60	56	52	49
2 x 10	4,0	0,7	1,8	17,3	1,91	390	86	69	80	76	70	66
2 x 16	5,0	0,7	1,8	19,4	1,21	520	115	91	105	99	91	86
2 x 25	6,2	0,9	1,8	23,0	0,780	765	149	119	135	128	118	111
2 x 35	7,4	0,9	1,8	25,7	0,554	1020	185	140	166	156	144	136
2 x 50	8,9	1,0	1,8	29,3	0,386	1400	225	175	205	193	178	168

Permissible current rating values are according to:
 - two-phase circuit for two-core cables
 - laying depth of 0,8 m for buried cables

N.B. K=1: resistivity of the ground equal to 1,0 K-m/W
 K=1,5: resistivity of the ground equal to 1,5 K-m/W

Three-core

Formation	Approx. conductor Ø	Average insulation thickness	Average sheath thickness	Max. external Ø	Max. electrical resistance at 20°C	Approx. cable weight	Current rating A					
							in air a 30°C	in pipe in air at 30°C	buried at 20°C		buried pipe at 20°C	
									K = 1	K = 1,5	K = 1	K = 1,5
n° x mm²	mm	mm	mm	mm	Ω/km	kg/km						
3 x 1,5	1,5	0,7	1,8	12,5	13,3	150	23	19	23	22	20	19
3 x 2,5	2,0	0,7	1,8	13,6	7,98	190	32	26	30	29	27	25
3 x 4	2,5	0,7	1,8	14,9	4,95	250	42	35	39	37	34	32
3 x 6	3,0	0,7	1,8	16,2	3,30	320	54	44	50	47	43	41
3 x 10	4,0	0,7	1,8	18,2	1,91	470	75	60	67	63	58	55
3 x 16	5,0	0,7	1,8	20,6	1,21	640	100	80	88	83	76	72
3 x 25	6,2	0,9	1,8	24,5	0,780	960	127	105	113	107	99	93
3 x 35	7,4	0,9	1,8	27,3	0,554	1290	158	128	139	131	121	114
3 x 50	8,9	1,0	1,8	31,2	0,386	1785	192	154	172	162	149	141
3 x 70	10,5	1,1	1,9	35,6	0,272	2700	246	194	212	200	184	174
3 x 95	12,2	1,1	2,0	40,0	0,206	3410	298	233	251	237	218	206
3 x 120	13,8	1,2	2,1	44,4	0,161	4340	346	268	290	274	252	238
3 x 150	15,4	1,4	2,3	49,5	0,129	5404	399	300	332	313	288	272
3 x 185	16,9	1,6	2,4	55,2	0,106	6550	456	340	373	352	324	306
3 x 240	19,5	1,7	2,6	61,9	0,0801	8475	538	398	439	414	382	360
3 x 300	23,0	1,8	2,8	68,0	0,0641	10440	621	-	-	-	-	-

Permissible current rating values are according to:
 - two-phase circuit for two-core cables
 - laying depth of 0,8 m for buried cables

N.B. K=1: resistivity of the ground equal to 1,0 K-m/W
 K=1,5: resistivity of the ground equal to 1,5 K-m/W

Four-core

Formation	Approx. conductor Ø	Average insulation thickness	Average sheath thickness	Max. external Ø	Max. electrical resistance at 20°C	Approx. cable weight	Current rating A									
							n° x mm ²	mm	mm	mm	in air a 30°C	in pipe in air at 30°C	buried at 20°C		buried pipe at 20°C	
													K = 1	K = 1,5	K = 1	K = 1,5
4 x 1,5	1,5	0,7	1,8	13,4	13,3	170	23	19	23	22	20	19				
4 x 2,5	2,0	0,7	1,8	14,6	7,98	220	32	26	30	29	27	25				
4 x 4	2,5	0,7	1,8	16,0	4,95	295	42	35	39	37	34	32				
4 x 6	3,0	0,7	1,8	17,5	3,30	385	54	44	50	47	43	41				
4 x 10	4,0	0,7	1,8	19,8	1,91	575	75	60	67	63	58	55				
4 x 16	5,0	0,7	1,8	22,4	1,21	795	100	80	88	83	76	72				
4 x 25	6,2	0,9	1,8	26,8	0,780	1205	127	105	113	107	99	93				
4 x 35 (*)	7,4	0,9	1,8	30,5	0,554	1750	158	128	139	131	121	114				
4 x 50 (*)	8,9	1,0	1,8	34,1	0,386	2530	192	154	172	162	149	141				
4 x 70 (*)	10,5	1,1	1,9	36,6	0,272	3600	246	194	212	200	184	174				
4 x 95 (*)	12,2	1,1	2,1	41,5	0,206	4380	298	233	251	237	218	206				
4 x 120 (*)	13,8	1,2	2,2	45,8	0,161	5585	346	268	290	274	252	238				
4 x 150 (*)	15,4	1,4	2,4	52,1	0,129	6920	399	300	332	313	288	272				
4 x 185 (*)	16,9	1,6	2,5	61,1	0,106	8364	456	340	373	352	324	306				
4 x 240 (*)	19,5	1,7	2,7	68,8	0,0801	10830	538	398	439	414	382	360				
3x35+25	7,4/6,2	0,9/0,9	1,8	29,2	0,554/0,780	1535	158	128	139	131	121	114				
3x50+25	8,9/6,2	1,0/0,9	1,8	32,4	0,386/0,780	2020	192	154	172	162	149	141				
3x70+35	10,5/7,4	1,1/0,9	1,8	37,0	0,272/0,554	3030	246	194	212	200	184	174				
3x95+50	12,2/8,9	1,1/1,0	2,1	42,0	0,206/0,386	3915	298	233	251	237	218	206				
3x120+70	13,8/10,5	1,2/1,1	2,2	46,9	0,161/0,272	5040	346	268	290	274	252	238				
3x150+95	15,4/12,2	1,4/1,1	2,4	52,5	0,129/0,206	6300	399	300	332	313	288	272				
3x185+95	16,9/12,2	1,6/1,1	2,5	57,3	0,106/0,206	8325	456	340	373	352	324	306				
3x240+150	19,5/15,4	1,7/1,4	2,7	65,5	0,0801/0,129	9930	538	398	439	414	382	360				

(*) = This formation is not part of the CEI UNEL
 Permissible current rating values are according to:
 - three-phase circuit
 - laying depth of 0,8 m for buried cables

N.B. K=1: resistivity of the ground equal to 1,0 K-m/W
 K=1,5: resistivity of the ground equal to 1,5 K-m/W

Five-core

Formation	Approx. conductor Ø	Average insulation thickness	Average sheath thickness	Max. external Ø	Max. electrical resistance at 20°C	Approx. cable weight	Current rating A									
							n° x mm ²	mm	mm	mm	in air a 30°C	in pipe in air at 30°C	buried at 20°C		buried pipe at 20°C	
													K = 1	K = 1,5	K = 1	K = 1,5
5G1,5	1,5	0,7	1,8	14,4	13,3	195	23	19	23	22	20	19				
5G2,5	2,0	0,7	1,8	15,6	7,98	260	32	26	30	29	27	25				
5G4	2,5	0,7	1,8	17,3	4,95	345	42	35	39	37	34	32				
5G6	3,0	0,7	1,8	18,9	3,30	455	54	44	50	47	43	41				
5G10	4,0	0,7	1,8	21,5	1,91	680	75	60	67	63	58	55				
5G16	5,0	0,7	1,8	24,4	1,21	970	100	80	88	86	76	72				
5G25	6,2	0,9	1,8	29,3	0,780	1470	127	105	113	107	99	93				
5G35	7,4	0,9	1,8	32,8	0,554	1990	158	128	139	131	121	114				
5G50	8,9	1,0	2,0	38,2	0,386	3030	192	154	172	162	149	141				
5G70 (*)	10,5	1,1	2,2	43,7	0,272	4190	246	194	212	200	184	174				

(*) = This formation is not part of the CEI UNEL
 Permissible current rating values are according to:
 - three-phase circuit
 - laying depth of 0,8 m for buried cables

N.B. K=1: resistivity of the ground equal to 1,0 K-m/W
 K=1,5: resistivity of the ground equal to 1,5 K-m/W

Multi-core / signalling and control

Formation n° x mm ²	Approx. conductor Ø mm	Average insulation thickness mm	Average sheath thickness mm	Max. external Ø mm	Max. electrical resistance at 20°C Ω/km	Approx. cable weight kg/km	Current rating A			
							in air at 30°C	in pipe in air at 30°C	buried pipe at 20°C	
K = 1	K = 1,5									
7 x 1,5	1,5	0,7	1,8	15,4	13,3	260	13	11,5	18,5	16
10 x 1,5	1,5	0,7	1,8	18,7	13,4	340	13	11,5	18,5	16
12 x 1,5	1,5	0,7	1,8	19,3	13,4	380	11	9,5	14,5	12,5
16 x 1,5	1,5	0,7	1,8	21,1	13,4	480	11	9,5	14,5	12,5
19 x 1,5	1,5	0,7	1,8	22,1	13,4	535	9	8	13	11,5
24 x 1,5	1,5	0,7	1,8	25,4	13,5	640	9	8	13	11,5
7 x 2,5	2,0	0,7	1,8	16,8	7,98	381	17,5	15,5	24	21
10 x 2,5	2,0	0,7	1,8	20,6	8,06	462	17,5	15,5	24	21
12 x 2,5	2,0	0,7	1,8	21,3	8,06	530	13,5	12	20	17,5
16 x 2,5	2,0	0,7	1,8	23,3	8,06	670	13,5	12	20	17,5
19 x 2,5	2,0	0,7	1,8	24,5	8,06	755	12	10,5	16	14
24 x 2,5	2,0	0,7	1,8	28,3	8,10	915	12	10,5	16	14

Permissible current rating values are according to:
 - two-phase circuit for two-core cables
 - laying depth of 0,8 m for buried cables

N.B. K=1: resistivity of the ground equal to 1,0 K-m/W
 K=1,5: resistivity of the ground equal to 1,5 K-m/W

C A B L E S F O R A M O V I N G W O R L D

TRATOS[®] ENERGY DNOs

Tratos Utility cables are designed and tested to meet relevant UK, European and International standards. Manufactured in state of the art manufacturing facilities, the company's purpose-built, in-house Fire, Chemical, Electrical and Physical testing facilities and laboratories deliver peace of mind to customers ensuring their choice of Utility cable products meet all statutory and regulatory requirements.



www.tratosgroup.com



FG16OH2R16-0,6/1 kV cable

TRATOS FG16OH2R16-0,6/1 kV

Reference Guidance CEI 20-67:

Cable suitable for energy supply in industry, building sites and construction industry, when is required protection from electromagnetic interference. For fixed wiring indoors and outdoors, even wet; for direct and indirect underground wiring. Suitable for installation at open air, on walls, metal structures, cable trays, pipes, wiring holders and similar devices. Suitable for bundle installations in environments at risk of fire.

Reference Construction Products Regulation 305/2011 EU and Standard EN 50575:

Given its properties of limiting the development of fire and heat emission, the cable is suitable for the supply of electricity in buildings and other civil engineering works.

FEATURES AND PERFORMANCES

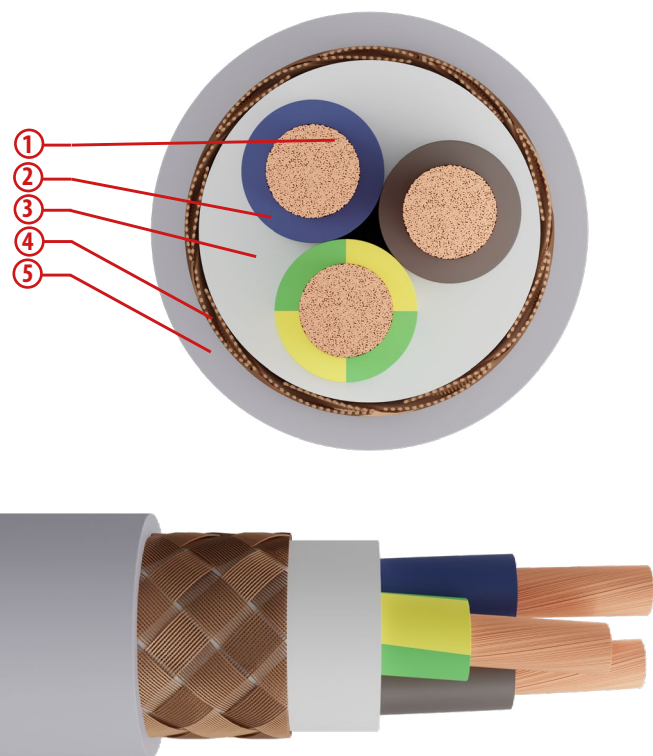

CONSTRUCTION

1. CLASS 5, FLEXIBLE, PLAIN COPPER WIRE
2. RUBBER COMPOUND, G16 QUALITY
3. THERMOPLASTIC, PENETRATING BETWEEN THE CORES WITH FUNCTION OF INNER SHEATH
4. PLAIN COPPER BRAID
5. PVC, R16 QUALITY

Structure and electrical, physical, mechanical requirements: CEI 20-13 IEC 60502-1 CEI UNEL 35318 (energy) CEI UNEL 35322 (control)

- Low Voltage Directive 2014/35/EU
- RoHS Directive 2011/65/EU

Special features

Good resistance to grease and mineral oils. Good flexibility and behaviour at low temperatures. UV resistance.

Cable Marking

Tratos FG16OH2R16 0,6/1 kV [form.] Cca-s3,d1,a3 IEMMEQU EFP [year] [traceability] [metric]

Colours

- TWO-CORE
- THREE-CORE
- FOUR-CORE
- FIVE-CORE

The cores in multiple cables for signal and control are black, numbered, with or without GREEN/YELLOW

Installation conditions

Minimum installation temperature	0°C
Recommended min. bending radius	8 times the cable diameter
Recommended maximum tensile stress	50 N/mm ² of the cross-section of the copper

Functional characteristics

Rated voltage: U ₀ /U	600/1000 V a.c. 1500 V d.c.
Max. rated voltage U _m	1200 V a.c. 1800 V d.c. also earthwards
Max. operating temperature	90°C
Min. operating temperature	-15°C (without mechanical shocks)
Max. short circuit temperature	250°C

Two-core

Formation	Approx. conductor Ø	Average insulation thickness	Average sheath thickness	Max. external Ø	Max. electrical resistance at 20°C	Approx. cable weight	Current rating A					
							in air a 30°C	in pipe in air at 30°C	buried at 20°C		buried pipe at 20°C	
									K = 1	K = 1,5	K = 1	K = 1,5
2 x 1,5	1,5	0,7	1,8	12,7	13,3	170	26	22	28	26	25	23
2 x 2,5	2,0	0,7	1,8	13,7	7,98	205	36	30	37	35	32	30
2 x 4	2,5	0,7	1,8	14,9	4,95	270	49	40	48	45	41	39
2 x 6	3,0	0,7	1,8	16,1	3,30	325	63	51	60	56	52	49
2 x 10	4,0	0,7	1,8	18,2	1,91	455	86	69	80	76	70	66
2 x 16	5,0	0,7	1,8	20,4	1,21	620	115	91	105	99	91	86
2 x 25	6,2	0,9	1,8	24,0	0,780	885	149	119	135	128	118	111
2 x 35	7,4	0,9	1,8	26,6	0,554	1165	185	140	166	156	144	136
2 x 50	8,9	1,0	1,8	30,5	0,386	1620	225	175	205	193	178	168
2 x 70	10,5	1,1	1,8	34,3	0,272	2190	289	221	250	238	218	207

N.B. Permissible current rating values are according to:
- two-phase circuit

N.B. K=1: resistivity of the ground equal to 1,0 K-m/W
K=1,5: resistivity of the ground equal to 1,5 K-m/W

Three-core

Formation	Approx. conductor Ø	Average insulation thickness	Average sheath thickness	Max. external Ø	Max. electrical resistance at 20°C	Approx. cable weight	Current rating A					
							in air a 30°C	in pipe in air at 30°C	buried at 20°C		buried pipe at 20°C	
									K = 1	K = 1,5	K = 1	K = 1,5
3 x 1,5	1,5	0,7	1,8	13,3	13,3	185	23	19	23	22	20	19
3 x 2,5	2,0	0,7	1,8	14,3	7,98	230	32	26	30	29	27	25
3 x 4	2,5	0,7	1,8	15,6	4,95	305	42	35	39	37	34	32
3 x 6	3,0	0,7	1,8	16,9	3,30	380	54	44	50	47	43	41
3 x 10	4,0	0,7	1,8	19,2	1,91	540	75	60	67	63	58	55
3 x 16	5,0	0,7	1,8	21,5	1,21	745	100	80	88	83	76	72
3 x 25	6,2	0,9	1,8	25,4	0,780	1095	127	105	113	107	99	93
3 x 35	7,4	0,9	1,8	28,3	0,554	1450	158	128	139	131	121	114
3 x 50	8,9	1,0	1,8	32,4	0,386	2010	192	154	172	162	149	141
3 x 70	10,5	1,1	1,9	36,8	0,272	2745	246	194	212	200	184	174
3 x 95	12,2	1,1	2,0	41,2	0,206	3455	298	233	251	237	218	206
3 x 120	13,8	1,2	2,1	45,8	0,161	4400	346	268	290	274	252	238
3 x 150	15,4	1,4	2,3	50,9	0,129	5500	399	300	332	313	294	272
3 x 185	16,9	1,6	2,4	56,6	0,106	6680	456	340	373	352	330	306

N.B. Permissible current rating values are according to:
- three-phase circuit

N.B. K=1: resistivity of the ground equal to 1,0 K-m/W
K=1,5: resistivity of the ground equal to 1,5 K-m/W

Four-core

Formation	Approx. conductor Ø	Average insulation thickness	Average sheath thickness	Max. external Ø	Max. electrical resistance at 20°C	Approx. cable weight	Current rating A												
							n° x mm²	mm	mm	mm	mm	Ω/km	kg/km	in air a 30°C	in pipe in air at 30°C	buried at 20°C		buried pipe at 20°C	
																K = 1	K = 1,5	K = 1	K = 1,5
4 x 1,5	1,5	0,7	1,8	14,1	13,3	210	23	19	23	22	20	19							
4 x 2,5	2,0	0,7	1,8	15,3	7,98	265	32	26	30	29	27	25							
4 x 4	2,5	0,7	1,8	16,7	4,95	355	42	35	39	37	34	32							
4 x 6	3,0	0,7	1,8	18,4	3,30	450	54	44	50	47	43	41							
4 x 10	4,0	0,7	1,8	20,8	1,91	655	75	60	67	63	58	55							
4 x 16	5,0	0,7	1,8	23,4	1,21	920	100	80	88	83	76	72							
4 x 25	6,2	0,9	1,8	27,7	0,780	1360	127	105	113	107	99	93							
4 x 95 (*)	12,2	1,1	2,2	45,5	0,206	4435	298	233	251	237	218	206							
4 x 120 (*)	13,8	1,2	2,3	50,6	0,161	5610	346	268	290	274	252	238							
4 x 150 (*)	15,4	1,4	2,5	56,7	0,129	7050	399	300	332	313	288	272							
4 x 185 (*)	16,9	1,6	2,6	61,6	0,106	8515	456	340	373	352	324	306							
3x35+25	7,4/6,2	0,9/0,9	1,8	30,4	0,554/0,780	1735	158	128	139	131	121	114							
3x50+25	8,9/6,2	1,0/0,9	1,8	33,6	0,386/0,780	2270	192	154	172	162	149	141							
3x70+35	10,5/7,4	1,1/0,9	1,8	38,2	0,272/0,554	3090	246	194	212	200	184	174							
3x95+50	12,2/8,9	1,1/1,0	2,1	43,4	0,206/0,386	3890	298	233	251	237	218	206							
3x120+70	13,8/10,5	1,2/1,1	2,2	48,3	0,161/0,272	5120	346	268	290	274	252	238							
3x150+95	15,4/12,2	1,4/1,1	2,4	53,9	0,129/0,206	6420	399	300	332	313	288	272							
3x185+95	16,9/12,2	1,6/1,1	2,5	58,8	0,106/0,206	7630	456	340	373	352	324	306							
3x240+150	19,5/15,4	1,7/1,4	2,7	66,9	0,0801/0,129	10090	538	398	439	414	382	360							

(*) = This formation is without IMQ certificate

N.B. Permissible current rating values are according to:

- three-phase circuit

- laying depth of 0,8 m for buried cables

N.B. K=1: resistivity of the ground equal to 1,0 K-m/W

K=1,5: resistivity of the ground equal to 1,5 K-m/W

Five-core

Formation	Approx. conductor Ø	Average insulation thickness	Average sheath thickness	Max. external Ø	Max. electrical resistance at 20°C	Approx. cable weight	Current rating A												
							n° x mm²	mm	mm	mm	mm	Ω/km	kg/km	in air a 30°C	in pipe in air at 30°C	buried at 20°C		buried pipe at 20°C	
																K = 1	K = 1,5	K = 1	K = 1,5
5G1,5	1,5	0,7	1,8	15,1	13,3	245	23	19	23	22	20	19							
5G2,5	2,0	0,7	1,8	16,4	7,98	315	32	26	30	29	27	25							
5G4	2,5	0,7	1,8	18,2	4,95	415	42	35	39	37	34	32							
5G6	3,0	0,7	1,8	19,8	3,30	540	54	44	50	47	43	41							
5G10	4,0	0,7	1,8	22,4	1,91	785	75	60	67	63	58	55							
5G16	5,0	0,7	1,8	25,4	1,21	1110	100	80	88	86	76	72							
5G25	6,2	0,9	1,8	30,5	0,780	1685	127	105	113	107	99	93							
5G35	7,4	0,9	1,8	34,0	0,554	2235	158	128	139	131	121	114							

N.B. Permissible current rating values are according to:

- three-phase circuit

- laying depth of 0,8 m for buried cables

N.B. K=1: resistivity of the ground equal to 1,0 K-m/W

K=1,5: resistivity of the ground equal to 1,5 K-m/W

Multi-core / signalling and control

Formation	Approx. conductor \emptyset	Average insulation thickness	Average sheath thickness	Max. external \emptyset	Max. electrical resistance at 20°C	Approx. cable weight	Current rating A			
							in air at 30°C	in pipe in air at 30°C	buried pipe at 20°C	
									K = 1	K = 1,5
n° x mm ²	mm	mm	mm	mm	Ω /km	kg/km				
7G1,5	1,5	0,7	1,8	15,4	13,3	260	13	11,5	18,5	16
10G1,5	1,5	0,7	1,8	18,7	13,4	340	13	11,5	18,5	16
12G1,5	1,5	0,7	1,8	19,3	13,4	380	11	9,5	14,5	12,5
16G1,5	1,5	0,7	1,8	21,1	13,4	480	11	9,5	14,5	12,5
19G1,5	1,5	0,7	1,8	22,1	13,4	535	9	8	13	11,5
24G1,5	1,5	0,7	1,8	25,4	13,5	640	9	8	13	11,5
7G2,5	2,0	0,7	1,8	16,8	7,98	381	17,5	15,5	24	21
10G2,5	2,0	0,7	1,8	20,6	8,06	462	17,5	15,5	24	21
12G2,5	2,0	0,7	1,8	21,3	8,06	530	13,5	12	20	17,5
16G2,5	2,0	0,7	1,8	23,3	8,06	670	13,5	12	20	17,5
19G2,5	2,0	0,7	1,8	24,5	8,06	755	12	10,5	16	14
24G2,5	2,0	0,7	1,8	28,3	8,10	915	12	10,5	16	14

(*) also available without the green/yellow
 N.B. Permissible current rating values are according to:
 - all conductors are charged (except for the green/yellow).
 - laying depth of 0,8 m for buried cables

N.B. K=1: resistivity of the ground equal to 1,0 K-m/W
 K=1,5: resistivity of the ground equal to 1,5 K-m/W

TRATOS General Cables®

FG16M16-0,6/1 kV | FG16OM16-0,6/1 kV cable

TRATOS FG16M16-0,6/1 kV TRATOS FG16OM16-0,6/1 kV

Reference Guidance CEI 20-67:

Cable suitable for energy supply in public places of fire hazard such as schools, offices, theatres, exhibitions, libraries, hospitals, museums and hotels. For fixed wiring indoors and outdoors, even wet (AD7); for direct and indirect underground wiring. Suitable for installation at open air, on walls, metal structures, cable trays, pipes, wiring holders and similar devices. Suitable for bundle installations in environments at risk of fire.

Reference Construction Products Regulation 305/2011 EU and Standard EN 50575:

Given its properties of limiting the development of fire, heat emission and noxious fumes, the cable is suitable for the supply of electricity in buildings and other civil engineering works.

FEATURES AND PERFORMANCES

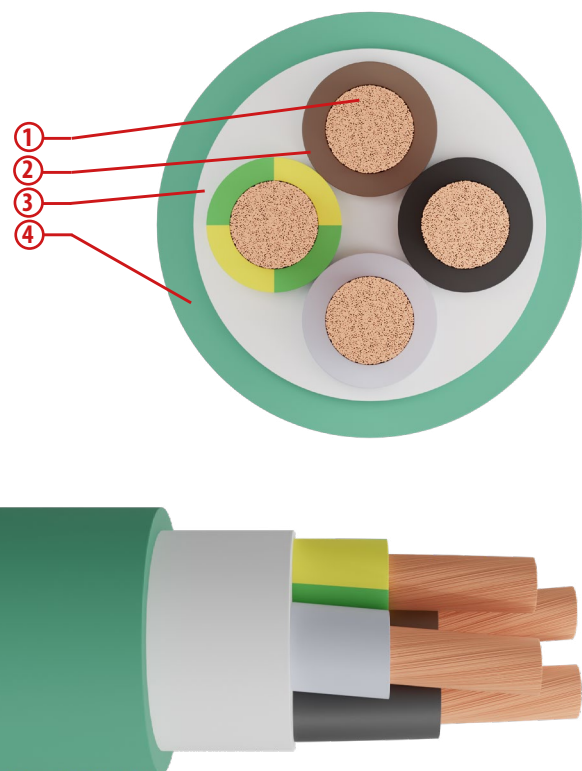

CONSTRUCTION

1. CLASS 5, FLEXIBLE, PLAIN COPPER WIRE
2. RUBBER COMPOUND, G16 QUALITY
3. LS0H THERMOPLASTIC, PENETRATING BETWEEN THE CORES
4. LS0H THERMOPLASTIC, M16 QUALITY

Structure and electrical, physical, mechanical requirements: CEI 20-13 ref. to CEI 20-38 CEI UNEL 35324 (energy) CEI UNEL 35328 (control)

- Low Voltage Directive 2014/35/EU
- RoHS Directive 2011/65/EU

Special features

Good resistance to oils, industrial greases and hydrocarbons. Good behaviour at low temperatures.

Cable Marking

Tratos FG16(O)M16 0,6/1 kV [form.] Cca-s1b,d1,a1 IEMMEQU EFP [year] [traceability] [metric]

Tratos FG16(O)M16 0,6/1 kV [form.] Cca-s1b,d1,a1 [year] [traceability] [metric]

Colours

- SINGLE-CORE ●
- TWO-CORE ● ●
- THREE-CORE ● ● ● or ● ● ●
- FOUR-CORE ● ● ● ● or ● ● ● ●
- FIVE-CORE ● ● ● ● ● or ● ● ● ● ●

The cores in multiple cables for signal and control are black, numbered, with or without GREEN/YELLOW

Installation conditions	
Minimum installation temperature	0°C
Recommended min. bending radius	4 times the cable diameter
Recommended maximum tensile stress	50 N/mm ² of the cross-section of the copper

Functional characteristics	
Rated voltage: U ₀ /U	600/1000 V a.c. 1500 V d.c.
Max. rated voltage U _m	1200 V a.c. 1800 V d.c. also earthwards
Voltage test	4000 V
Max. operating temperature	90°C
Min. operating temperature	-15°C (without mechanical shocks)
Max. short circuit temperature	250°C

Single-core

Formation n° x mm ²	Approx. conductor Ø mm	Average insulation thickness mm	Average sheath thickness mm	Max. external Ø mm	Max. electrical resistance at 20°C Ω/km	Approx. cable weight kg/km	Current rating A					
							in air a 30°C	in pipe in air at 30°C	buried at 20°C		buried pipe at 20°C	
									K = 1	K = 1,5	K = 1	K = 1,5
1 x 10	4,0	0,7	1,4	10,9	1,91	175	80	66	73	68	64	59
1 x 16	5,0	0,7	1,4	11,4	1,21	245	107	88	96	89	83	77
1 x 25	6,2	0,9	1,4	13,2	0,780	340	141	117	124	115	108	100
1 x 35	7,4	0,9	1,4	14,6	0,554	440	176	144	150	139	131	121
1 x 50	8,9	1,0	1,4	16,4	0,386	590	216	175	186	173	162	150
1 x 70	10,5	1,1	1,4	18,3	0,272	795	279	222	229	212	199	184
1 x 95	12,2	1,1	1,5	20,4	0,206	995	342	269	270	250	234	217
1 x 120	13,8	1,2	1,5	22,4	0,161	1340	400	312	312	289	271	251
1 x 150	15,4	1,4	1,6	24,8	0,129	1635	464	355	356	330	310	287
1 x 185	16,9	1,6	1,6	27,0	0,106	1955	533	417	401	371	343	323
1 x 240	19,5	1,7	1,7	30,2	0,0801	2495	634	490	471	436	409	379
1 x 300	22,0	1,8	1,8	33,0	0,0641	3040	736	-	533	493	463	429
1 x 400 (*)	25,1	2,0	1,9	-	0,0486	4010	868	-	621	575	540	500
1 x 500 (*)	28,5	2,2	2,1	-	0,0384	4960	998	-	705	650	540	565
1 x 630 (*)	32,8	2,4	2,3	-	0,0287	6645	1151	-	785	741	683	645

(*) = This formation is not part of the CEI UNEL
 Permissible current rating values are according to:
 - three-phase circuit
 - laying depth of 0,8 m for buried cables

N.B. K=1: resistivity of the ground equal to 1,0 K-m/W
 K=1,5: resistivity of the ground equal to 1,5 K-m/W

Two-core

Formation n° x mm ²	Approx. conductor Ø mm	Average insulation thickness mm	Average sheath thickness mm	Max. external Ø mm	Max. electrical resistance at 20°C Ω/km	Approx. cable weight kg/km	Current rating A					
							in air a 30°C	in pipe in air at 30°C	buried at 20°C		buried pipe at 20°C	
									K = 1	K = 1,5	K = 1	K = 1,5
2 x 1,5	1,5	0,7	1,8	12,0	13,3	140	26	22	28	26	25	23
2 x 2,5	2,0	0,7	1,8	13,0	7,98	175	36	30	37	35	32	30
2 x 4	2,5	0,7	1,8	14,2	4,95	220	49	40	48	45	41	39
2 x 6	3,0	0,7	1,8	15,4	3,30	280	63	51	60	56	52	49
2 x 10	4,0	0,7	1,8	17,3	1,91	390	86	69	80	76	70	66
2 x 16	5,0	0,7	1,8	19,4	1,21	610	115	91	105	99	91	86
2 x 25	6,2	0,9	1,8	23,0	0,780	880	149	119	135	128	118	111
2 x 35	8,9	1,0	1,8	27,7	0,554	1180	185	140	166	156	144	136
2 x 50	10,5	1,1	1,8	29,3	0,386	1590	225	175	205	193	178	168
2 x 70	12,2	1,1	1,8	33,1	0,272	2140	289	221	252	238	219	207

Permissible current rating values are according to:
 - two-phase circuit for two-core cables
 - laying depth of 0,8 m for buried cables

N.B. K=1: resistivity of the ground equal to 1,0 K-m/W
 K=1,5: resistivity of the ground equal to 1,5 K-m/W

Three-core

Formation n° x mm ²	Approx. conductor Ø mm	Average insulation thickness mm	Average sheath thickness mm	Max. external Ø mm	Max. electrical resistance at 20°C Ω/km	Approx. cable weight kg/km	Current rating A					
							in air a 30°C	in pipe in air at 30°C	buried at 20°C		buried pipe at 20°C	
									K = 1	K = 1,5	K = 1	K = 1,5
3 x 1,5	1,5	0,7	1,8	12,5	13,3	160	23	19	23	22	20	19
3 x 2,5	2,0	0,7	1,8	13,6	7,98	200	32	26	30	29	27	25
3 x 4	2,5	0,7	1,8	14,9	4,95	260	42	35	39	37	34	32
3 x 6	3,0	0,7	1,8	16,2	3,30	330	54	44	50	47	43	41
3 x 10	4,0	0,7	1,8	18,2	1,91	480	75	60	67	63	58	55
3 x 16	5,0	0,7	1,8	20,6	1,21	745	100	80	88	83	76	72
3 x 25	6,2	0,9	1,8	24,5	0,780	1080	127	105	113	107	99	93
3 x 35	7,4	0,9	1,8	27,3	0,554	1465	158	128	139	131	121	114
3 x 50	8,9	1,0	1,8	31,2	0,386	1990	192	154	172	162	149	141
3 x 70	10,5	1,1	1,9	35,6	0,272	2720	246	194	212	200	184	174
3 x 95	12,2	1,1	2,0	40,0	0,206	3430	298	233	251	237	218	206
3 x 120	13,8	1,2	2,1	44,4	0,161	4360	346	268	290	274	252	238
3 x 150	15,4	1,4	2,3	49,5	0,129	5420	399	300	332	313	288	272
3 x 185	16,9	1,6	2,4	55,2	0,106	6570	456	340	373	352	324	306
3 x 240	19,5	1,7	2,6	61,9	0,0801	8495	538	398	439	414	382	360

Permissible current rating values are according to:
 - two-phase circuit for two-core cables
 - laying depth of 0,8 m for buried cables

N.B. K=1: resistivity of the ground equal to 1,0 K-m/W
 K=1,5: resistivity of the ground equal to 1,5 K-m/W

Four-core

Formation n° x mm ²	Approx. conductor Ø mm	Average insulation thickness mm	Average sheath thickness mm	Max. external Ø mm	Max. electrical resistance at 20°C Ω/km	Approx. cable weight kg/km	Current rating A					
							in air a 30°C	in pipe in air at 30°C	buried at 20°C		buried pipe at 20°C	
									K = 1	K = 1,5	K = 1	K = 1,5
4 x 1,5	1,5	0,7	1,8	13,4	13,3	185	23	19	23	22	20	19
4 x 2,5	2,0	0,7	1,8	14,6	7,98	240	32	26	30	29	27	25
4 x 4	2,5	0,7	1,8	16,0	4,95	280	42	35	39	37	34	32
4 x 6	3,0	0,7	1,8	17,5	3,30	405	54	44	50	47	43	41
4 x 10	4,0	0,7	1,8	19,8	1,91	600	75	60	67	63	58	55
4 x 16	5,0	0,7	1,8	22,4	1,21	910	100	80	88	83	76	72
4 x 25	6,2	0,9	1,8	26,8	0,780	1300	127	105	113	107	99	93
4 x 35 (*)	7,4	0,9	1,8	-	0,554	1875	158	128	139	131	121	114
4 x 50 (*)	8,9	1,0	1,8	-	0,386	2590	192	154	172	162	149	141
4 x 70 (*)	10,5	1,1	2,0	-	0,272	3685	246	194	212	200	184	174
4 x 95 (*)	12,2	1,1	2,1	-	0,206	4485	298	233	251	237	218	206
3x35+25	7,4/6,2	0,9/0,9	1,8	29,2	0,554/0,780	1730	158	128	139	131	121	114
3x50+25	8,9/6,2	1,0/0,9	1,8	32,4	0,386/0,780	2230	192	154	172	162	149	141
3x70+35	10,5/7,4	1,1/0,9	1,9	37,0	0,272/0,554	3045	246	194	212	200	184	174
3x95+50	12,2/8,9	1,1/1,0	2,1	42,0	0,206/0,386	3930	298	233	251	237	218	206
3x120+70	13,8/10,5	1,2/1,1	2,2	46,9	0,161/0,272	5060	346	268	290	274	252	238
3x150+95	15,4/12,2	1,4/1,1	2,4	52,5	0,129/0,206	6320	399	300	332	313	288	272
3x185+95	16,9/12,2	1,6/1,1	2,5	57,3	0,106/0,206	7430	456	340	373	352	324	306
3x240+150	19,5/15,4	1,7/1,4	2,7	65,5	0,0801/0,129	9950	538	398	439	414	382	360

(*) = This formation is not part of the CEI UNEL
 Permissible current rating values are according to:
 - three-phase circuit
 - laying depth of 0,8 m for buried cables

N.B. K=1: resistivity of the ground equal to 1,0 K-m/W
 K=1,5: resistivity of the ground equal to 1,5 K-m/W

Five-core

Formation n° x mm ²	Approx. conductor Ø mm	Average insulation thickness mm	Average sheath thickness mm	Max. external Ø mm	Max. electrical resistance at 20°C Ω/km	Approx. cable weight kg/km	Current rating A					
							in air a 30°C	in pipe in air at 30°C	buried at 20°C		buried pipe at 20°C	
									K = 1	K = 1,5	K = 1	K = 1,5
5G1,5	1,5	0,7	1,8	14,4	13,3	225	23	19	23	22	20	19
5G2,5	2,0	0,7	1,8	15,6	7,98	290	32	26	30	29	27	25
5G4	2,5	0,7	1,8	17,3	4,95	385	42	35	39	37	34	32
5G6	3,0	0,7	1,8	18,9	3,30	500	54	44	50	47	43	41
5G10	4,0	0,7	1,8	21,5	1,91	750	75	60	67	63	58	55
5G16	5,0	0,7	1,8	24,4	1,21	1100	100	80	88	83	76	72
5G25	6,2	0,9	1,8	29,3	0,780	1630	127	105	113	107	99	93
5G35	7,4	0,9	1,8	32,8	0,554	2205	158	128	139	131	121	114
5G50	8,9	1,0	2,0	38,2	0,386	3055	192	154	172	162	149	141
5G70 *	10,5	1,1	2,1	-	0,272	4215	246	194	212	200	184	174
5G95 *	12,2	1,1	2,3	-	0,206	5375	298	233	251	237	218	206
5G120 *	13,8	1,2	2,4	-	0,161	6800	346	268	290	274	252	238
5G150 *	15,4	1,4	2,6	-	0,129	8400	399	300	332	313	288	272

(*) = This formation is not part of the CEI UNEL
Permissible current rating values are according to:
- three-phase circuit
- laying depth of 0,8 m for buried cables

N.B. K=1: resistivity of the ground equal to 1,0 K-m/W
K=1,5: resistivity of the ground equal to 1,5 K-m/W

Multi-core / signalling and control

Formation n° x mm ²	Approx. conductor Ø mm	Average insulation thickness mm	Average sheath thickness mm	Max. external Ø mm	Max. electrical resistance at 20°C Ω/km	Approx. cable weight kg/km	Current rating A			
							in air a 30°C	in pipe in air at 30°C	buried pipe at 20°C	
									K = 1	K = 1,5
5G1,5	1,5	0,7	1,8	14,4	13,3	230	16	14	26	23
7 x 1,5	1,5	0,7	1,8	15,4	13,3	275	13	11,5	18,5	16
10 x 1,5	1,5	0,7	1,8	18,7	13,4	365	13	11,5	18,5	16
12 x 1,5	1,5	0,7	1,8	19,3	13,4	410	11	9,5	14,5	12,5
16 x 1,5	1,5	0,7	1,8	21,1	13,4	510	11	9,5	14,5	12,5
19 x 1,5	1,5	0,7	1,8	22,1	13,4	580	9	8	13	11,5
24 x 1,5	1,5	0,7	1,8	25,4	13,5	700	9	8	13	11,5
7 x 2,5	2,0	0,7	1,8	16,8	7,98	310	17,5	15,5	24	21
10 x 2,5	2,0	0,7	1,8	20,6	8,06	395	17,5	15,5	24	21
12 x 2,5	2,0	0,7	1,8	21,3	8,06	445	13,5	12	20	17,5
16 x 2,5	2,0	0,7	1,8	23,3	8,06	545	13,5	12	20	17,5
19 x 2,5	2,0	0,7	1,8	24,5	8,06	615	12	10,5	16	14
24 x 2,5	2,0	0,7	1,8	28,3	8,10	750	12	10,5	16	14
7G4 (**)	2,5	0,7	1,8	20,0	0,554	520	27	23	30	28

(**) = This formation is not included in the UNEL CEI tables.
(* = This formation is not included in the UNEL CEI tables.
N.B. Permissible current rating values are according to:
- three-phase circuit
- laying depth of 0,8 m for buried cables

N.B. K=1: resistivity of the ground equal to 1,0 K-m/W
K=1,5: resistivity of the ground equal to 1,5 K-m/W

FG18(O)M16-0,6/1 kV cable

TRATOS FG18(O)M16-0,6/1 kV

Reference Guidance CEI 20-67:

Suitable for bundle installations in environments at higher risk in case of fire due to high overcrowding or long evacuation time in case of fire or major damages to animals and things such as airports, railway stations, marine stations, subways, road and railway tunnels. Suitable for internal or external environments, even wet. For fixed outdoor laying, in pipe or duct, on walls and metallic structures.

Reference Construction Products Regulation 305/2011 EU and Standard EN 50575:

Given its properties of limiting the development of fire, heat emission and noxious fumes, the cable is suitable for the supply of electricity in buildings and other civil engineering works.

FEATURES AND PERFORMANCES

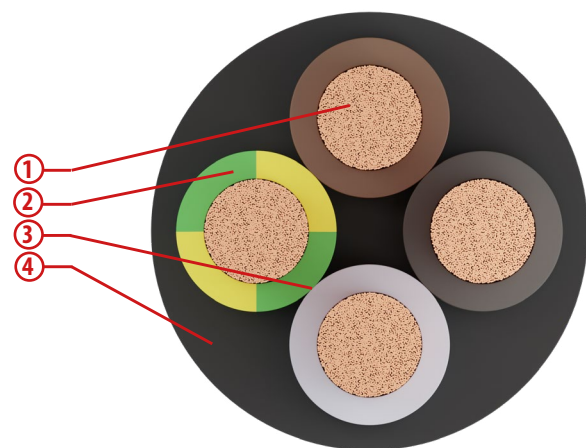

CONSTRUCTION

1. CLASS 5, FLEXIBLE, PLAIN COPPER WIRE
2. RUBBER COMPOUND, G18 QUALITY
3. RUBBER NON-HYGROSCOPIC PENETRATING BETWEEN THE CORES (ONLY ON MULTICORE CABLES)
4. LSOH THERMOPLASTIC, M16 QUALITY

Structure and electrical, physical, mechanical requirements: CEI UNEL 35312 CEI 20-38 IEC 60502-1

- **Low Voltage Directive** 2014/35/EU
- **RoHS Directive** 2011/65/EU

Special features

Good resistance to grease and mineral oils.
Good flexibility and behaviour at low temperatures.

Cable Marking

Tratos FG18(O)M16-0,6/1 kV [form.] B2ca-s1a,d1,a1 IEMMEQU EFP [year] [traceability] [metric]

Tratos FG18OM16-0,6/1 kV [form.] B2ca-s1a,d1,a1 [year] [traceability] [metric]

Colours

- SINGLE-CORE ●
- TWO-CORE ● ●
- THREE-CORE ● ● ● or ● ● ●
- FOUR-CORE ● ● ● ● or ● ● ● ●

Installation conditions

Minimum installation temperature	0°C
Recommended min. bending radius	6 times the cable diameter
Recommended maximum tensile stress	50 N/mm ² of the cross-section of the copper

Functional characteristics

Rated voltage: U ₀ /U	0,6/1 kV
Max. operating temperature	90°C
Min. operating temperature	-25°C (without mechanical shocks)
Max. short circuit temperature	250°C

FG18M16-0,6/1 kV - Single-core

Formation	Approx. conductor Ø	Average insulation thickness	Average sheath thickness	Max. electrical resistance at 20°C	Max. external Ø	Approx. cable weight	Current rating A					
							in air a 30°C	in pipe in air at 30°C	buried at 20°C		buried pipe at 20°C	
									K = 1	K = 1,5	K = 1	K = 1,5
n° x mm ²	mm	mm	mm	Ω/km	mm	kg/km						
1 x 10	3,9	1,0	1,4	1,91	12,5	160	80	66	73	68	64	59
1 x 16	5,0	1,0	1,4	1,21	13,6	230	107	88	96	89	83	77
1 x 25	6,2	1,2	1,4	0,780	15,6	330	141	117	124	115	108	100
1 x 35	7,3	1,2	1,4	0,554	16,6	440	176	144	150	139	131	121
1 x 50	8,8	1,4	1,4	0,386	18,7	605	216	175	186	173	162	150
1 x 70	10,5	1,4	1,5	0,272	20,7	820	279	222	228	212	198	184
1 x 95	11,9	1,6	1,5	0,206	22,5	1070	342	269	270	250	234	217
1 x 120	13,8	1,6	1,6	0,161	25,0	1340	400	312	311	289	271	251
1 x 150	15,4	1,8	1,7	0,129	27,5	1630	464	355	356	330	310	287
1 x 185	16,9	2,0	1,7	0,106	29,3	1965	533	417	401	371	349	323
1 x 240	19,4	2,2	1,8	0,0801	32,5	2490	634	490	435	436	409	379
1 x 300 (*)	21,6	2,4	1,9	0,0641	36,3	3430	736	-	522	493	454	429
1 x 400 (*)	25,1	2,6	2,0	0,0486	/	3820	868	-	621	650	599	565
1 x 500 (*)	28,5	2,8	2,0	0,0384	/	4720	998	-	785	741	683	645

(*) = This formation is without IMQ EFP certification
 N.B. Permissible current rating values are according to:
 - three conductors charged
 - laying depth of 0,8 m for buried cables

N.B. K=1: resistivity of the ground equal to 1,0 K-m/W
 K=1,5: resistivity of the ground equal to 1,5 K-m/W

FG18OM16-0,6/1 kV - Two-core

Formation	Approx. conductor Ø	Average insulation thickness	Average sheath thickness	Max. electrical resistance at 20°C	Max. external Ø	Approx. cable weight	Current rating A					
							in air a 30°C	in pipe in air at 30°C	buried at 20°C		buried pipe at 20°C	
									K = 1	K = 1,5	K = 1	K = 1,5
n° x mm ²	mm	mm	mm	Ω/km	mm	kg/km						
2 x 1,5	1,5	1,0	1,8	13,3	13,4	230	26	22	27	26	24	23
2 x 2,5	2,0	1,0	1,8	7,98	14,4	270	36	30	36	34	32	30
2 x 4	2,5	1,0	1,8	4,95	15,6	320	49	40	48	45	41	39
2 x 6	3,0	1,0	1,8	3,30	16,8	400	63	51	59	56	52	49
2 x 10	4,0	1,0	1,8	1,81	18,7	530	86	69	80	76	70	66
2 x 16 *	5,0	1,0	1,8	1,21	-	735	115	91	105	99	91	86
2 x 25 *	6,2	1,0	1,8	0,780	-	1010	149	119	135	128	118	111
2 x 35 *	7,3	1,2	1,8	0,554	-	1350	185	140	166	156	144	136
2 x 50 *	8,9	1,2	1,9	0,386	-	1750	225	175	205	193	178	168
2 x 70 *	10,5	1,4	2,1	0,272	-	2445	289	221	252	238	219	207

(*) = This formation is without IMQ EFP certification
 N.B. Permissible current rating values are according to:
 - two conductors charged
 - laying depth of 0,8 m for buried cables

N.B. K=1: resistivity of the ground equal to 1,0 K-m/W
 K=1,5: resistivity of the ground equal to 1,5 K-m/W

FG18OM16-0,6/1 kV - Three-core

Formation	Approx. conductor Ø	Average insulation thickness	Average sheath thickness	Max. electrical resistance at 20°C	Max. external Ø	Approx. cable weight	Current rating A												
							n° x mm ²	mm	mm	mm	Ω/km	mm	kg/km	in air a 30°C	in pipe in air at 30°C	buried at 20°C		buried pipe at 20°C	
																K = 1	K = 1,5	K = 1	K = 1,5
3 x 1,5	1,5	1,0	1,8	13,3	14,1	260		23	19,5	23	22	20	19						
3 x 2,5	2,0	1,0	1,8	7,98	15,1	305		32	26	31	29	26	25						
3 x 4	2,5	1,0	1,8	4,95	16,4	385		42	35	39	37	34	32						
3 x 6	3,0	1,0	1,8	3,30	17,7	450		54	44	50	47	43	41						
3 x 10	4,0	1,0	1,8	1,81	19,8	635		75	60	67	63	58	55						
3 x 16 *	5,0	1,0	1,8	1,21	-	865		100	80	88	83	76	72						
3 x 25 *	6,2	1,0	1,8	0,780	-	1235		127	105	113	107	98	93						
3 x 35 *	7,4	1,2	1,8	0,554	-	1630		158	128	139	131	121	114						
3 x 50 *	8,9	1,2	1,8	0,386	-	2225		192	154	172	162	149	141						
3 x 70 *	10,5	1,4	2,1	0,272	-	3040		246	194	212	200	184	174						

(*) = This formation is without IMQ EFP certification

N.B. Permissible current rating values are according to:

- two conductors charged for two-core cables
- three conductors charged for three-core, four-core and five-core cables
- laying depth of 0,8 m for buried cables

N.B. K=1: resistivity of the ground equal to 1,0 K-m/W

K=1,5: resistivity of the ground equal to 1,5 K-m/W

FG18OM16-0,6/1 kV - Four-core

Formation	Approx. conductor Ø	Average insulation thickness	Average sheath thickness	Max. electrical resistance at 20°C	Max. external Ø	Approx. cable weight	Current rating A												
							n° x mm ²	mm	mm	mm	Ω/km	mm	kg/km	in air a 30°C	in pipe in air at 30°C	buried at 20°C		buried pipe at 20°C	
																K = 1	K = 1,5	K = 1	K = 1,5
4 x 1,5	1,5	1,0	1,8	13,3	15,2	330		23	19,5	23	22	20	19						
4 x 2,5	2,0	1,0	1,8	7,98	16,3	400		32	26	31	29	26	25						
4 x 4	2,5	1,0	1,8	4,95	17,8	480		42	35	39	37	34	32						
4 x 6	3,0	1,0	1,8	3,30	19,2	580		54	44	50	47	43	41						
4 x 10	4,0	1,0	1,8	1,81	21,5	765		75	60	67	63	58	55						
4 x 16 *	5,0	1,0	1,8	1,21	-	1050		100	80	88	83	76	72						
4 x 25 *	6,2	1,0	1,8	0,780	-	1515		127	105	113	107	98	93						
4 x 50 *	8,9	1,2	1,9	0,386	-	2860		192	154	172	162	149	141						
3x35+1G25 *	7,4/6,2	1,2	1,8	0,554	-	1905		158	128	139	131	121	114						
3x50+1G25 *	8,9/6,2	1,2	1,9	0,386	-	2490		192	154	172	162	149	141						
3x70+1G35 *	10,5/7,4	1,4	2,1	0,272	-	3375		246	194	212	200	184	174						

(*) = This formation is not part of the CEI UNEL

Permissible current rating values are according to:

- three-phase circuit
- laying depth of 0,8 m for buried cables

N.B. K=1: resistivity of the ground equal to 1,0 K-m/W

K=1,5: resistivity of the ground equal to 1,5 K-m/W

FG18OM16-0,6/1 kV - Five-core

Formation	Approx. conductor Ø	Average insulation thickness	Average sheath thickness	Max. electrical resistance at 20°C	Max. external Ø	Approx. cable weight	Current rating A												
							n° x mm ²	mm	mm	mm	Ω/km	mm	kg/km	in air at 30°C	in pipe in air at 30°C	buried at 20°C		buried pipe at 20°C	
																K = 1	K = 1,5	K = 1	K = 1,5
5G1,5	1,5	1,0	1,8	13,3	16,3	350	23	19,5	23	22	20	19							
5G2,5	2,0	1,0	1,8	7,98	17,6	425	32	26	31	29	26	25							
5G4	2,5	1,0	1,8	4,95	19,2	525	42	35	39	37	34	32							
5G6	3,0	1,0	1,8	3,30	20,8	670	54	44	50	47	43	41							
5G10	4,0	1,0	1,8	1,81	23,4	935	75	60	67	63	58	55							
5G16 *	5,0	1,0	1,8	1,21	-	1275	100	80	88	83	76	72							
5G25 *	6,2	1,0	1,9	0,780	-	1895	127	105	113	107	98	93							
5G35 *	7,4	1,2	1,9	0,554	-	2515	158	128	139	131	121	114							
5G50 *	8,9	1,2	2,0	0,386	-	3470	192	154	172	162	149	141							

(*) = This formation is without IMQ EFP certification
 N.B. Permissible current rating values are according to:
 - three conductors charged
 - laying depth of 0,8 m for buried cables

N.B. K=1: resistivity of the ground equal to 1,0 K-m/W
 K=1,5: resistivity of the ground equal to 1,5 K-m/W

TRATOS General Cables®

FTG18M16-0,6/1 kV | FTG18OM16-0,6/1 kV cable

TRATOS FTG18M16-0,6/1 kV TRATOS FTG18OM16-0,6/1 kV

Suitable for the transport of power and transmission of signals and controls in electrical installations where is required the maximum security in case of fire, such as emergency and alarm lights, automatic fire detection, automatic fire extinguishing devices, automatic door opening, ventilation, air conditioning system and emergency telephone system. For static use indoor even in wet environments and outdoor. Can be laid on brickwork, metal structures, gangways, pipes, ducts or similar closed systems. Allowed for underground laying also unprotected.

Reference Construction Products Regulation 305/2011 EU and Standard EN 50575:

Given its properties of limiting the development of fire, heat emission and noxious fumes, the cable is suitable for the supply of electricity in buildings and other civil engineering works.

FEATURES AND PERFORMANCES

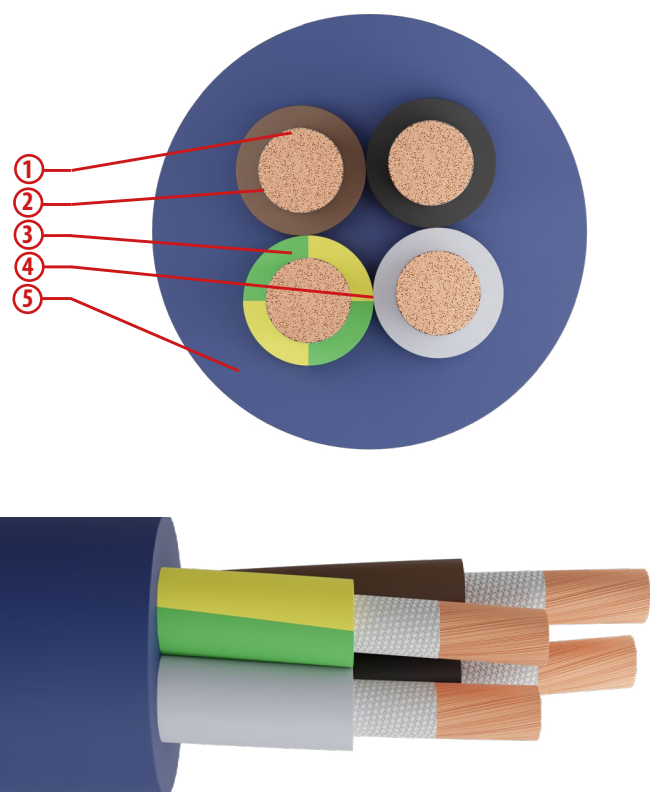

CONSTRUCTION

1. CLASS 5, FLEXIBLE, PLAIN COPPER WIRE
2. GLASS/MICA TAPE, WRAPPED IN SPIRAL
3. RUBBER COMPOUND, G18 QUALITY
4. LS0H THERMOPLASTIC, PENETRATING BETWEEN THE CORES WITH FUNCTION OF INNER SHEATH
5. LS0H THERMOPLASTIC, M16 QUALITY

LS0H = Low Smoke Zero Halogen

Structure and electrical, physical, mechanical requirements: CEI 20-45 CEI 20-38

- **Fire resistance** EN 50200
EN 50362
- **Low Voltage Directive** 2014/35/EU
- **RoHS Directive** 2011/65/EU

Special features

Good resistance to grease and mineral oils. Good flexibility and behaviour at low temperatures. Ensures the functioning in case of fire and mechanical shocks, for at least 120 minutes at a temperature of 830° C.

Cable Marking

Tratos TRISECUR RF FTG18(O)M16 0,6/1 kV [form.] B2ca-s1a,d1,a1 IEMMEQU EFP CEI 20-45 PH 120 [year] [traceability] [metric]
Tratos TRISECUR RF FTG18(O)M16 0,6/1 kV [form.] B2ca-s1a,d1,a1 IEMMEQU EFP CEI 20-45 F 120 [year] [traceability] [metric]

Colours

- SINGLE-CORE ●
- TWO-CORE ● ●
- THREE-CORE ● ● ● or ● ● ●
- FOUR-CORE ● ● ● ● or ● ● ● ●
- FIVE-CORE ● ● ● ● ● or ● ● ● ● ●

The cores in multiple cables for signal and control are black, numbered, with or without GREEN/YELLOW

Installation conditions

Minimum installation temperature	0°C
Recommended min. bending radius	4 times the cable diameter
Recommended maximum tensile stress	50 N/mm ² of the cross-section of the copper

Functional characteristics

Rated voltage: U _o /U	0,6/1 kV
Max. operating temperature	90°C
Min. operating temperature	-15°C (without mechanical shocks)
Max. short circuit temperature	250°C

FTG18M16 - Single-core

Formation	Approx. conductor Ø	Average insulation thickness	Average sheath thickness	Approx. external Ø	Max. electrical resistance at 20°C	Approx. cable weight	Current rating A												
							n° x mm ²	mm	mm	mm	mm	Ω/km	kg/km	in air a 30°C	in pipe in air at 30°C	buried at 20°C		buried pipe at 20°C	
																K = 1	K = 1,5	K = 1	K = 1,5
1 x 6 *	3,0	1,0	1,8	-	3,30	140	58	48	55	51	48	44							
1 x 10	3,9	1,0	1,4	10,0	1,91	195	80	66	73	68	64	59							
1 x 16	5,0	1,0	1,4	11,0	1,21	260	107	88	96	89	83	77							
1 x 25	6,1	1,2	1,4	12,6	0,780	365	141	117	124	115	108	100							
1 x 35	7,3	1,2	1,4	13,6	0,554	480	176	144	150	139	131	121							
1 x 50	8,8	1,4	1,4	15,5	0,386	645	216	175	186	173	162	150							
1 x 70	10,5	1,4	1,5	17,1	0,272	850	279	222	229	212	199	184							
1 x 95	11,9	1,6	1,6	19,1	0,206	1080	342	269	270	250	234	217							
1 x 120	13,9	1,6	1,6	20,5	0,161	1360	400	312	312	289	271	251							
1 x 150	15,4	1,8	1,7	23,1	0,129	1640	464	355	356	330	310	287							
1 x 185	16,9	2,0	1,8	25,3	0,106	1985	533	417	401	371	343	323							
1 x 240	19,4	2,2	1,9	28,3	0,0801	2530	634	490	471	436	409	379							
1 x 300	21,6	2,4	2,0	31,5	0,0641	3180	736	-	532	493	463	429							
1 x 400	25,1	2,6	2,1	34,9	0,0486	4130	868	-	621	575	540	500							
1 x 500	28,5	2,8	2,3	39,2	0,0384	5100	998	-	700	649	610	565							
1 x 630	32,8	3,0	2,4	43,1	0,0287	6785	1151	-	800	741	696	645							

(*) = This formation is without IMQ EFP certification
 N.B. Permissible current rating values are according to:
 - three conductors charged
 - laying depth of 0,8 m for buried cables

N.B. K=1: resistivity of the ground equal to 1,0 K-m/W
 K=1,5: resistivity of the ground equal to 1,5 K-m/W

FTG18OM16 - Two-core

Formation	Approx. conductor Ø	Average insulation thickness	Average sheath thickness	Approx. external Ø	Max. electrical resistance at 20°C	Approx. cable weight	Current rating A												
							n° x mm ²	mm	mm	mm	mm	Ω/km	kg/km	in air a 30°C	in pipe in air at 30°C	buried at 20°C		buried pipe at 20°C	
																K = 1	K = 1,5	K = 1	K = 1,5
2 x 1,5	1,5	1,0	1,8	12,0	13,30	215	26	22	28	26	25	23							
2 x 2,5	1,9	1,0	1,8	12,8	7,98	260	36	30	37	35	32	30							
2 x 4	2,4	1,0	1,8	13,8	4,95	315	49	40	48	45	41	39							
2 x 6	3,0	1,0	1,8	15,0	3,30	390	63	51	56	53	49	46							
2 x 10	3,9	1,0	1,8	17,0	1,91	525	86	69	80	76	70	66							
2 x 16	5,0	1,0	1,8	19,0	1,21	710	115	91	105	99	91	86							
2 x 25	6,1	1,2	1,8	22,2	0,780	1000	149	119	135	128	118	111							
2 x 35	7,3	1,2	1,8	24,1	0,554	1325	185	146	166	156	144	136							
2 x 50	8,8	1,4	1,9	27,9	0,386	1800	225	175	205	193	178	168							

N.B. Permissible current rating values are according to:
 - two-phase circuit
 - laying depth of 0,8 m for buried cables

N.B. K=1: resistivity of the ground equal to 1,0 K-m/W
 K=1,5: resistivity of the ground equal to 1,5 K-m/W

FTG18OM16 - Three-core

Formation	Approx. conductor Ø	Average insulation thickness	Average sheath thickness	Approx. external Ø	Max. electrical resistance at 20°C	Approx. cable weight	Current rating A												
							n° x mm ²	mm	mm	mm	mm	Ω/km	kg/km	in air a 30°C	in pipe in air at 30°C	buried at 20°C		buried pipe at 20°C	
																K = 1	K = 1,5	K = 1	K = 1,5
3 x 1,5	1,5	1,0	1,8	12,6	13,3	245	23	19,5	23	22	20	19							
3 x 2,5	1,9	1,0	1,8	13,5	7,98	295	32	26	30	29	27	25							
3 x 4	2,4	1,0	1,8	14,6	4,95	365	42	35	39	37	34	32							
3 x 6	3,0	1,0	1,8	15,9	3,30	455	54	44	50	47	43	41							
3 x 10	3,9	1,0	1,8	18,0	1,91	625	75	60	67	63	58	55							
3 x 16	5,0	1,0	1,8	20,2	1,21	865	100	80	88	83	76	72							
3 x 25	6,1	1,2	1,8	23,6	0,780	1230	127	105	113	107	99	93							
3 x 35	7,3	1,2	1,8	25,6	0,554	1635	158	128	139	131	121	114							
3 x 50	8,8	1,4	1,9	29,9	0,386	2255	192	154	172	162	150	141							
3 x 70	10,5	1,4	2,1	33,7	0,272	3005	246	194	212	200	184	174							
3 x 95	11,9	1,6	2,2	38,3	0,206	3865	298	233	251	237	218	206							
3 x 120	13,9	1,6	2,3	41,6	0,161	4905	346	268	290	274	252	238							

(*) = This formation is without IMQ EFP certification
 N.B. Permissible current rating values are according to:
 - three-phase circuit
 - laying depth of 0,8 m for buried cables

N.B. K=1: resistivity of the ground equal to 1,0 K-m/W
 K=1,5: resistivity of the ground equal to 1,5 K-m/W

FTG18OM16 - Four-core

Formation	Approx. conductor Ø	Average insulation thickness	Average sheath thickness	Approx. external Ø	Max. electrical resistance at 20°C	Approx. cable weight	Current rating A												
							n° x mm ²	mm	mm	mm	mm	Ω/km	kg/km	in air a 30°C	in pipe in air at 30°C	buried at 20°C		buried pipe at 20°C	
																K = 1	K = 1,5	K = 1	K = 1,5
4 x 1,5	1,5	1,0	1,8	13,6	13,30	285	23	19,5	23	22	20	19							
4 x 2,5	1,9	1,0	1,8	14,6	7,98	345	32	26	30	29	27	25							
4 x 4	2,4	1,0	1,8	15,8	4,95	430	42	35	39	37	34	32							
4 x 6	3,0	1,0	1,8	17,3	3,30	545	54	44	50	47	43	41							
4 x 10	3,9	1,0	1,8	19,7	1,91	760	75	60	67	63	58	55							
4 x 16	5,0	1,0	1,8	22,1	1,21	1060	100	80	88	83	76	72							
4 x 25	6,1	1,2	1,8	25,7	0,780	1520	127	105	113	107	99	93							
3x35+25	7,3/6,1	1,2/1,2	1,9	31,3	0,554/0,780	1915	158	128	139	131	121	114							
3x50+25	8,8/6,1	1,2/1,2	2,0	31,3	0,386/0,780	2500	192	154	172	162	150	141							
3x70+35	10,5/7,3	1,4/1,2	2,1	35,0	0,272/0,554	3345	246	194	212	200	184	174							
3x95+50	11,9/8,8	1,6/1,2	2,3	40,1	0,206/0,386	4365	298	233	251	237	218	206							

N.B. Permissible current rating values are according to:
 - three-phase circuit
 - laying depth of 0,8 m for buried cables

N.B. K=1: resistivity of the ground equal to 1,0 K-m/W
 K=1,5: resistivity of the ground equal to 1,5 K-m/W

FTG18OM16 - Five-core

Formation	Approx. conductor \emptyset	Average insulation thickness	Average sheath thickness	Approx. external \emptyset	Max. electrical resistance at 20°C	Approx. cable weight	Current rating A					
							in air a 30°C	in pipe in air at 30°C	buried at 20°C		buried pipe at 20°C	
									K = 1	K = 1,5	K = 1	K = 1,5
n° x mm ²	mm	mm	mm	mm	Ω /km	kg/km						
5 x 1,5	1,5	1,0	1,8	14,8	13,3	335	23	19,5	23	22	20	19
5 x 2,5	1,9	1,0	1,8	15,9	7,98	415	32	26	30	29	27	25
5 x 4	2,4	1,0	1,8	17,2	4,95	520	42	35	39	37	34	32
5 x 6	3,0	1,0	1,8	18,8	3,30	660	54	44	50	47	43	41
5 x 10	3,9	1,0	1,8	21,5	1,91	925	75	60	67	63	58	55
5 x 16	5,0	1,0	1,8	24,2	1,21	1295	100	80	88	83	76	72
5 x 25	6,1	1,2	1,9	28,5	0,780	1870	127	105	113	107	99	93
5 x 35	7,3	1,2	2,0	31,3	0,554	2510	158	128	139	131	121	114
5 x 50	8,8	1,4	2,2	36,8	0,386	3495	192	154	172	162	150	141
5 x 70	10,5	1,4	2,3	41,9	0,272	4685	246	194	212	200	184	174
5 x 95	11,9	1,6	2,5	47,4	0,206	5980	298	233	251	237	218	206
5 x 120	13,9	1,6	2,7	51,7	0,161	7600	346	268	290	274	252	238

N.B. Permissible current rating values are according to:
 - three-phase circuit
 - laying depth of 0,8 m for buried cables

N.B. K=1: resistivity of the ground equal to 1,0 K-m/W
 K=1,5: resistivity of the ground equal to 1,5 K-m/W

FTG18OM16 - Multi-core / signalling and control

Formation	Approx. conductor \emptyset	Average insulation thickness	Average sheath thickness	Approx. external \emptyset	Max. electrical resistance at 20°C	Approx. cable weight	Current rating A			
							in air a 30°C	in pipe in air at 30°C	buried at 20°C	
									K = 1	K = 1,5
n° x mm ²	mm	mm	mm	mm	Ω /km	kg/km				
7G1,5	1,5	1,0	1,8	15,9	13,30	390	13	11,5	18,5	16
10G1,5	1,5	1,0	1,8	19,8	13,40	530	13	11,5	18,5	16
12G1,5	1,5	1,0	1,8	20,4	13,40	590	11	9,5	14,5	12,5
16G1,5	1,5	1,0	1,8	22,6	13,40	735	11	9,5	14,5	12,5
19G1,5	1,5	1,0	1,8	23,7	13,40	820	9	8	13	11,5
24G1,5	1,5	1,0	1,9	27,6	13,50	1015	9	8	13	11,5
27G1,5	1,5	1,0	1,9	28,2	13,50	1110	9	8	13	11,5
7G2,5	1,9	1,0	1,8	17,1	7,98	480	17,5	15,5	24	21
10G2,5	1,9	1,0	1,8	21,4	8,06	660	17,5	15,5	24	21
12G2,5	1,9	1,0	1,8	22,1	8,06	740	13,5	12	20	17,5
16G2,5	1,9	1,0	1,8	24,5	8,06	935	13,5	12	20	17,5
19G2,5	1,9	1,0	2,0	25,7	8,06	1055	12	10,5	16	14
24G2,5	1,9	1,0	2,0	30,0	8,10	1305	12	10,5	16	14

(*) also available without the green/yellow
 N.B. Permissible current rating values are according to:
 - all conductors are charged (except for the green/yellow).
 - laying depth of 0,8 m for buried cables

N.B. K=1: resistivity of the ground equal to 1,0 K-m/W
 K=1,5: resistivity of the ground equal to 1,5 K-m/W

ARG16R16-0,6/1 kV cable

TRATOS ARG16R16-0,6/1 kV

Suitable for the transport of power in the industry, construction sites and housing. For static use outdoor and indoor, in brickwork, metal structures, gangways, pipes, ducts or similar closed systems. Allowed for underground laying also unprotected.

Reference Construction Products Regulation 305/2011 EU and Standard EN 50575:

Given its properties of limiting the development of fire and heat emission, the cable is suitable for the supply of electricity in buildings and other civil engineering works.

FEATURES AND PERFORMANCES

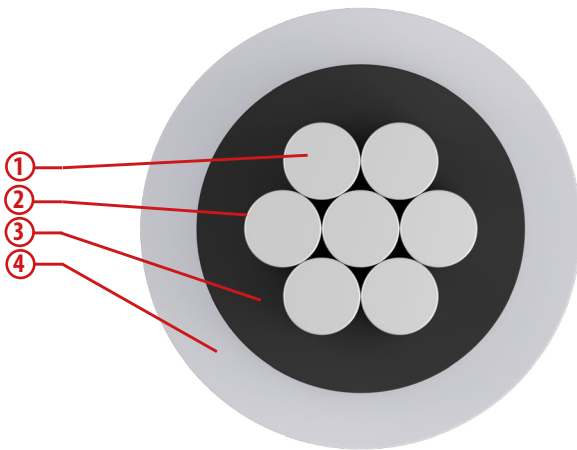

CONSTRUCTION

1. ALUMINUM, STRANDED WIRE, CLASS 2
2. RUBBER COMPOUND, G16 QUALITY
3. TERMOPLASTIC
4. PVC, R16 QUALITY

Structure and electrical, physical, mechanical requirements: CEI 20-13

- Corrosive gases or halogens EN 50267-2-1
- Low Voltage Directive 2014/35/EU
- RoHS Directive 2011/65/EU

Special features

Good resistance to grease and mineral oils. Good flexibility and behaviour at low temperatures. UV resistance.

Cable Marking

Made in Italy Tratos ARG16R16 0,6/1 kV [form.] Cca-s3,d1,a3 [year] [traceability] [metric]

Colours

SINGLE-CORE ●

Installation conditions

Minimum installation temperature	0°C
Recommended min. bending radius	6 times the cable diameter
Recommended maximum tensile stress	50 N/mm ² of the cross-section of the copper

Functional characteristics

Rated voltage: U ₀ /U	600/1000 V a.c. 1500 V d.c.
Max. rated voltage U _m	1200 V a.c. 1800 V d.c. also earthwards
Voltage test	4000 V
Max. operating temperature	90°C
Min. operating temperature	-15°C (without mechanical shocks)
Max. short circuit temperature	250°C

ARG16R16-0,6/1 kV

Formation n° x mm ²	Approx. conductor Ø mm	Average insulation thickness mm	Average sheath thickness mm	Max. external Ø mm	Max. electrical resistance at 20°C Ω/km	Approx. cable weight kg/km	Current rating A					
							in air at 30°C	in pipe in air at 30°C	buried at 20°C		buried pipe at 20°C	
									K = 1	K = 1,5	K = 1	K = 1,5
1 x 16	4,90	0,7	1,4	10,0	1,91	150	70	64	98	89	75	70
1 x 25	6,10	0,9	1,4	11,7	1,20	185	102	88	119	110	95	88
1 x 35	7,10	0,9	1,4	13,0	0,868	220	136	110	141	131	115	106
1 x 50	8,20	1,0	1,4	14,7	0,641	280	164	131	167	154	134	124
1 x 70	9,90	1,1	1,4	16,6	0,443	320	218	175	204	189	173	160
1 x 95	11,40	1,1	1,5	18,6	0,320	460	261	209	245	226	196	181
1 x 120	13,10	1,2	1,5	20,5	0,253	570	310	250	277	256	238	220
1 x 150	14,40	1,4	1,6	22,8	0,206	670	350	280	313	289	250	231
1 x 185	16,20	1,6	1,6	25,0	0,164	810	415	334	350	324	300	278
1 x 240	18,40	1,7	1,7	27,9	0,125	1025	490	392	413	382	331	306
1 x 300	20,65	1,8	1,8	30,7	0,100	1205	567	-	454	420	400	370
1 x 400	23,60	2,0	1,9	35,0	0,0778	1660	665	-	512	474	450	417
1 x 500	26,50	2,2	2,0	38,6	0,0605	1940	765	-	578	535	505	468
1 x 630	30,20	2,4	2,2	43,1	0,0469	2460	880	-	646	598	580	537

N.B. Permissible current rating values are according to:
 - three-phase circuit
 - laying depth of 0,8 m for buried cables

N.B. K=1: resistivity of the ground equal to 1,0 K-m/W
 K=1,5: resistivity of the ground equal to 1,5 K-m/W

TRATOS General Cables®

UG7OCR-0,6/1 kV | RG7OCR-0,6/1 kV cable

TRATOS UG7OCR-0,6/1 kV TRATOS RG7OCR-0,6/1 kV

Suitable for the transport of power in free air, for use outdoor and indoor. Installation in brickwork, metal structures, gangways, pipes, ducts or similar closed systems. Suitable for photovoltaic electrical system in the connection between the inverter and the power grid. Allowed for underground laying.

N.B. For applications not covered by Regulation EU 305/2011.

FEATURES AND PERFORMANCES

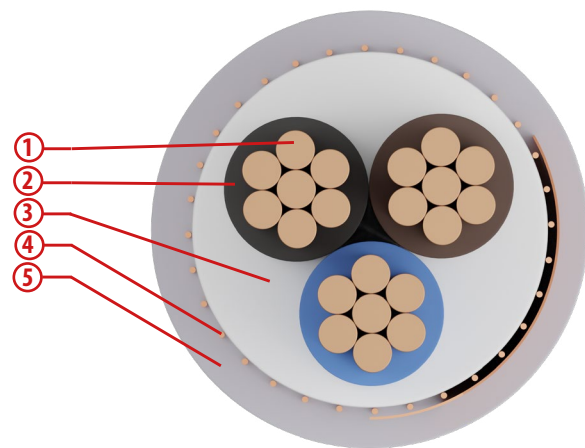

CONSTRUCTION

1. - CLASS 1, SOLID, PLAIN COPPER (CROSS-SECTION = 6MM²)
- CLASS 2, STRANDED WIRE, PLAIN COPPER (CROSS-SECTION ≥ 16MM²)
2. RUBBER COMPOUND, G7 QUAL
3. THERMOPLASTIC, PENETRATING BETWEEN THE CORES WITH FUNCTION OF INNER SHEATH
4. COPPER WIRES WITH COPPER TAPE HELICALLY WOUND
5. PVC, RZ QUALITY

Structure and electrical, physical, mechanical requirements: ENEL DC 4122 ENEL DC 4908 HD 603 CEI 20-48

- Flame propagation EN 60332-1-2
- Low Voltage Directive 2014/35/EU
- RoHS Directive 2011/65/EU

Cable Marking

Tratos UG7OCR 0,6/1 kV [form.] [year] [traceability] [metric]
Tratos RG7OCR 0,6/1 kV [form.] [year] [traceability] [metric]

Installation conditions

Minimum installation temperature	0°C
Recommended min. bending radius	14 times the cable diameter
Recommended maximum tensile stress	50 N/mm ² of the cross-section of the copper

Functional characteristics

Rated voltage: U _o /U	0,6/1 kV
Max. operating temperature of phase conductor	90°C
Max. operating temperature of concentric conductor	85°C
Min. operating temperature	-15°C (without mechanical shocks)
Max. short circuit temperature of phase conductor	250°C
Max. short circuit temperature of concentric conductor	160°C

UG70CR-0,6/1 kV | RG70CR-0,6/1 kV

Formation	Approx. conductor Ø	Average insulation thickness	Average sheath thickness	Max. external Ø	Max. electrical resistance at 20°C	Approx. cable weight	Current rating A			
							in air at 30°C	in pipe in air at 30°C	buried at 20°C	
									K = 1	K = 1,5
n° x mm ²	mm	mm	mm	mm	Ω/km	kg/km				
3x6+6C	2,7	0,7	1,8	19,1	3,08	450	54	48	66	53
3x16+16C	4,8	0,7	2,2	25,9	1,15	1020	107	89	114	91
3x25+25C	6,0	0,9	2,2	29,6	0,727	1575	133	117	145	116
3x50+25C	8,1	1,0	2,2	34,7	0,387	2380	198	175	208	166
3x95+50C	11,4	1,1	2,2	42,4	0,193	4350	306	269	311	249
3x150+95C	14,2	1,4	2,4	51,5	0,124	6980	407	359	389	311

N.B. K=1: resistivity of the ground equal to 1,0 K-m/W
 K=1,5: resistivity of the ground equal to 1,5 K-m/W

NPE SUN H1Z2Z2-K cable

TRATOS NPE SUN H1Z2Z2-K Cable for photovoltaic systems

Intended for use in photovoltaic installations acc. to HD 60364-7-712.

They are intended for permanent use outdoor and indoor, for free movable, free hanging and fixed installation. Installation also in conduits and trunkings on, in or under plaster as well as in appliances. Suitable for the application in/at equipment with protective insulation (protection class II).

FEATURES AND PERFORMANCES

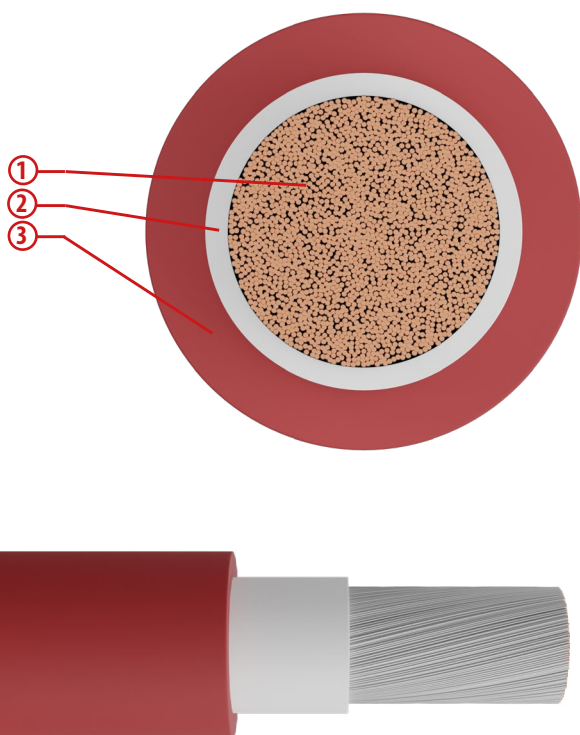

CONSTRUCTION

1. CLASS 5, FLEXIBLE, TINNED COPPER
2. COMPOUND CROSS-LINKED (LS0H)
3. COMPOUND CROSS-LINKED (LS0H)

LS0H = Low Smoke Zero Halogen

Structure and electrical, physical, mechanical requirements: EN 50618

• Flame propagation	EN 60332-1-2
• Corrosive gases or halogens	EN 50525-1
• Smoke density	EN 61034-2
• UV resistance	EN 50289-4-17 (A)
• Ozone resistance	EN 50396
• Resistance to heat stress	EN 60216-1 EN 60216-2
• Low Voltage Directive	2014/35/EU
• RoHS Directive	2011/65/EU

Installation conditions

Minimum installation temperature	-25°C
Recommended min. bending radius	4 times the cable diameter
Recommended maximum tensile stress	50 N/mm ² of the cross-section of the copper

Functional characteristics

Rated voltage: U _o /U	1000/1000 V a.c. 1500/1500 V d.c.
Max. voltage U _m (also to ground)	1800 V d.c.
Max. conductor operating temperature	90°C
Max. conductor temperature at a max. ambient temperature of 90°C	120°C (max. 20,000 hours)
Min. operating temperature	-40°C (without mechanical shocks)
Max. short circuit temperature	250°C referring to a period of 5 sec.

Special features

The cable is tested to work for at least 25 years.
Thermal endurance properties (temperature index TI): 120°C referring to 20.000 h (EN 60216-1).
Water resistance AD7 (EN 60529).

Cable Marking

Tratos NPE SUN H1Z2Z2-K [form.] mm² IEMMEQU [HAR] [year] (CE logo) [traceability] [metric]
Tratos NPE SUN H1Z2Z2-K [form.] mm² [year] (CE logo) [traceability] [metric]

NPE SUN H1Z2Z2-K

Formation	Approx. conductor \emptyset	Max. external \emptyset	Max. electrical resistance at 20°C	Approx. cable weight	Current rating at ambient temperature of 60°C and conductor temperature of 120°C		
					1 cable in free air	1 cable on surface	2 cables in contact on surface
					A	A	A
n° x mm ²	mm	mm	Ω /km	kg/km			
1 x 1,5	1,5	5,4	13,7	32	30	29	24
1 x 2,5	1,9	5,9	8,21	43	41	39	33
1 x 4	2,4	6,6	5,09	60	55	52	44
1 x 6	3,0	7,4	3,39	82	70	67	57
1 x 10	3,9	8,8	1,95	125	98	93	79
1 x 16	5,0	10,1	1,24	185	132	125	107
1 x 25	6,1	12,5	0,795	280	176	167	142
1 x 35	7,3	14,0	0,565	370	218	207	176
1 x 50	8,7	16,3	0,393	520	276	262	221
1 x 70	10,5	18,7	0,277	715	347	330	278
1 x 95	11,9	20,8	0,210	925	416	395	333
1 x 120	13,8	22,8	0,164	1165	488	464	390
1 x 150	15,3	25,5	0,132	1480	566	538	453
1 x 185	16,9	28,5	0,108	1825	644	612	515
1 x 240	19,4	32,1	0,0817	2345	775	736	620

Correction coefficients for ambient temperature other than 60°C

Ambient temperature (°C)	Correction factor
Up to 60	1,0
70	0,92
80	0,84
90	0,75

As for group installations, the correction coefficients of carrying capacity are included in document HD 60364-5-52:2011, table B.52.17.

NPE® SUN PLUS H1Z2Z2-K cable

TRATOS NPE® SUN PLUS H1Z2Z2-K Cable for photovoltaic systems

Intended for use in photovoltaic installations acc. to HD 60364-7-712.

They are intended for permanent use outdoor and indoor, for free movable, free hanging and fixed installation. Suitable for the application in/at equipment with protective insulation (protection class II).

Tratos allows, thanks to internal tests, the use of the cable for underground laying even direct if undergrounding guidelines are taken into consideration.

FEATURES AND PERFORMANCES

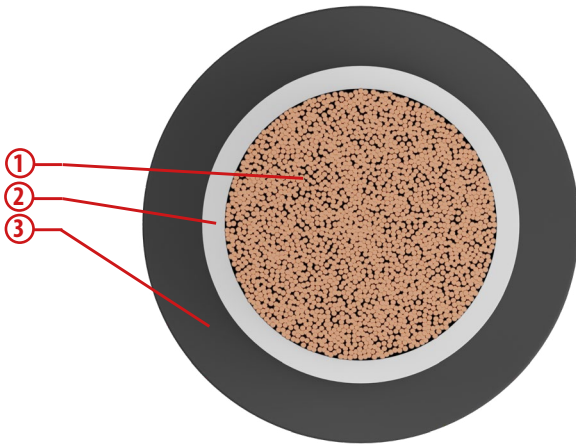

CONSTRUCTION

1. CLASS 5, FLEXIBLE, TINNED COPPER
2. COMPOUND CROSS-LINKED (LS0H)
3. COMPOUND CROSS-LINKED (LS0H)

LS0H = Low Smoke Zero Halogen

Structure and electrical, physical, mechanical requirements: EN 50618:2014 IEC 62930 IEC 131

• Flame propagation	EN 60332-1-2
• Corrosive gases or halogens	EN 50525-1
• Smoke density	EN 61034-2
• UV resistance	EN 50289-4-17 (A)
• Ozone resistance	EN 50396
• Resistance to heat stress	EN 60216-1 EN 60216-2
• Low Voltage Directive	2014/35/EU
• RoHS Directive	2011/65/EU

Special features

Thermal endurance properties (temperature index TI): 120°C referring to 20.000 h (EN 60216-1).

Water resistant according to AD8 classification, tested in according to EN 50525-2-21 Annex E (immersion for 100 days to 50°C):

- Minimum tensile strength after immersion > 7 MPa
- Minimum elongation at break after immersion > 200%
- Water absorption on sheath after immersion less than 40%.
- Insulation resistance tests with a minimum resistivity of 1011 Ω.cm measured after 14 days in water at 50°C.

Cable Marking

Tratos NPE SUN PLUS H1Z2Z2-K 1X[cross-section] mm2 HALOGEN FREE LOW SMOKE 62930 IEC 131 TÜV Rheinland [no. license] [year] (CE logo) [order n.] [metric]

Installation conditions	
Minimum installation temperature	-25°C
Recommended min. bending radius	12 times the cable diameter
Recommended maximum tensile stress	50 N/mm ² of the cross-section of the copper

Functional characteristics	
Rated voltage U ₀ /U between conductors and between conductor and earth	1000/1000 V a.c. 1500/1500 V d.c.
Max. voltage U _m (also to ground)	1800 V d.c.
Max. conductor operating temperature	90°C
Max. conductor temperature at a max. ambient temperature of 90°C	120°C (max. 20,000 hours)
Min. operating temperature	-40°C (without mechanical shocks)
Max. short circuit temperature	250°C referring to a period of 5 sec.

NPE® SUN PLUS H1Z2Z2-K

Formation	Approx. conductor Ø	Approx. external Ø	Max. electrical resistance at 20°C	Approx. cable weight	Current rating at ambient temperature of 60°C and conductor temperature of 120°C		
					1 cable in free air	1 cable on surface	2 cables in contact on surface
					A	A	A
1 x 4	2,4	5,20 ÷ 6,00	5,09	60	55	52	44
1 x 6	3,0	5,80 ÷ 6,60	3,39	82	70	67	57
1 x 10	3,9	6,90 ÷ 7,70	1,95	125	98	93	79

Correction coefficients for ambient temperature other than 60°C	
Ambient temperature (°C)	Correction factor
Up to 60	1,0
70	0,92
80	0,84
90	0,75

As for group installations, the correction coefficients of carrying capacity are included in document HD 60364-5-52:2011, table B.52.17.

RG26H1M16-12/20 kV | RG26H1M16-18/30 kV cable

SLIMPOWER PLUS HT 105 TRATOS RG26H1M16-12/20 kV TRATOS RG26H1M16-18/30 kVV

Suitable for energy transmission between transformer rooms and big power users; mostly suitable for premises with fire risk, and places where appliances, electrical (switch) boxes and instruments are operating and whose safeguard is fundamental. For laying on air, into tube or open pass. In case of UV exposure, appropriate protection is required. Can be laid underground, complying with art. 4.3.11 of CEI 11-17 standard.

Reference Construction Products Regulation 305/2011 EU and Standard EN 50575:

The cable is suitable for the supply of electricity in buildings and other civil engineering works.

FEATURES AND PERFORMANCES

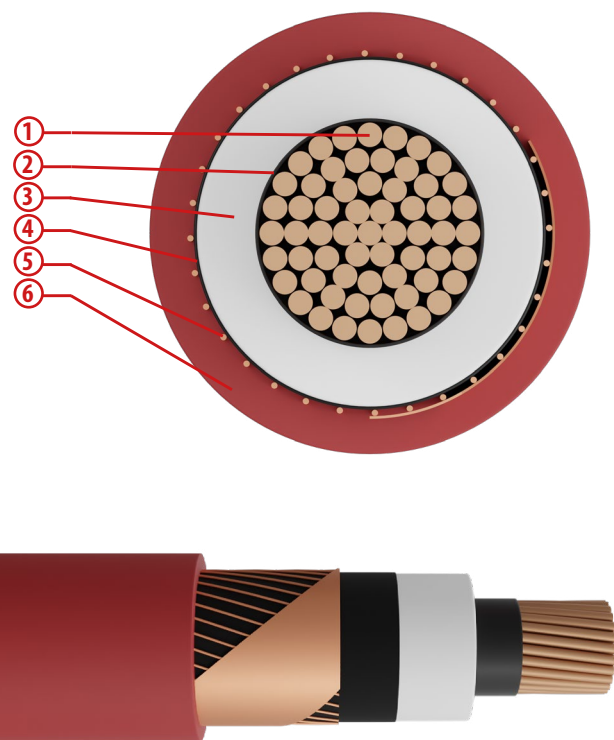

CONSTRUCTION

Single-core cables are insulated with HEPR rubber of G26 quality, with reduced thickness and maximum operating temperature of 105°C. In case of high temperature is allowed a 10% overload in continuous operation and/or higher margins in critical situations than traditional cables.

1. CLASS 2, COMPACT STRANDED WIRE, PLAIN COPPER
2. SEMICONDUCTOR LAYER: EXTRUDED
3. RUBBER COMPOUND, G26 QUALITY, PB FREE (HD 620 DIH 2)
4. SEMICONDUCTOR LAYER: EXTRUDED, COLD STRIPPING
5. PLAIN COPPER WIRES WITH HELICALLY WOUNDED COPPER TAPE
6. LS0H THERMOPLASTIC, M16 QUALITY

LS0H = Low Smoke Zero Halogen

N.B. The cable can be built in the three-pole version with helicallly wound cores. In this case, the initials becomes RG26H1M16X followed by rated voltage.

Structure and electrical, physical, mechanical requirements: CEI UNEL 35334 according to IEC 60502 CEI 20-13 HD 620

- **Resistance to hydrocarbons** CEI 20-34/0-1

Cable Marking

Pb free Tratos RG26H1M16 SLIMPOWER PLUS HT105 12/20 kV Cca-s1b,d1,a1 [form] [year] [traceability] [metric]

Pb free Tratos RG26H1M16 SLIMPOWER PLUS HT105 18/30 kV Cca-s1b,d1,a1 [form] [year] [traceability] [metric]

Functional characteristics	
Rated voltage Uo/U	RG26H1M16-12/20 kV: 12/20 kV RG26H1M16-18/30 kV: 18/30 kV
Max operating voltage Um	RG26H1M16-12/20 kV: 24 kV RG26H1M16-18/30 kV: 36 kV
Max. operating temperature	105°C
Min. operating temperature	-15°C (without mechanical shocks)
Max. short circuit temperature	300°C

Installation conditions	
Minimum installation temperature	0°C
Recommended min. bending radius	14 times the cable diameter
Recommended maximum tensile stress	60 N/mm ² of the cross-section of the copper

RG26H1M16 - 12/20 kV

U_o/U: 12/20 kV

U max: 24 kV

RG26H1M16-12/20 kV / Technical characteristics

Formation n° x mm ²	Approx. conductor Ø mm	Average insulation thickness mm	Average sheath thickness mm	Approx. external Ø mm	Approx. cable weight kg/km	Current rating A			
						in air		buried*	
						trefoil	flat	trefoil	flat
1 x 25	5,9	4,5	1,8	24,3	815	175	203	166	172
1 x 35	7,0	4,5	1,8	25,4	935	212	248	199	206
1 x 50	8,1	4,3	1,8	26,1	1060	253	297	235	244
1 x 70	9,7	4,1	1,9	27,3	1285	316	373	288	299
1 x 95	11,4	4,0	1,9	28,8	1565	385	455	345	358
1 x 120	13,0	4,0	2,0	30,4	1840	445	525	392	406
1 x 150	14,3	4,1	2,0	31,9	2155	506	595	440	454
1 x 185	16,0	4,2	2,1	33,8	2535	581	680	496	512
1 x 240	18,3	4,2	2,2	36,1	3150	688	802	574	591
1 x 300	20,6	4,3	2,2	39,0	3870	790	916	647	664
1 x 400	23,4	4,4	2,4	42,0	4735	914	1049	730	756
1 x 500	26,6	4,4	2,5	45,2	5855	1058	1208	828	848
1 x 630	30,1	4,4	2,6	48,8	7340	1219	1379	917	940

(*) Permissible current rating values are according to:

- ground thermal resistivity: 1,0 K-m/W

- ambient temperature 20°C

- laying depth of 0,8 m for buried cables

RG26H1M16-12/20 kV / Electrical characteristics

Formation n° x mm ²	Max. electrical resistance at 20°C Ω/km	Conductor apparent resistance at 105°C and 50Hz Ω/km		Phase reactance Ω/km		Capacity at 50Hz μF/km
		trefoil	flat	trefoil	flat	
1 x 25	0,727	0,970	0,970	0,14	0,20	0,17
1 x 35	0,524	0,669	0,669	0,13	0,19	0,20
1 x 50	0,387	0,517	0,517	0,13	0,18	0,22
1 x 70	0,268	0,358	0,358	0,12	0,18	0,25
1 x 95	0,193	0,258	0,258	0,11	0,17	0,29
1 x 120	0,153	0,205	0,205	0,11	0,17	0,31
1 x 150	0,124	0,166	0,166	0,11	0,16	0,34
1 x 185	0,0991	0,134	0,134	0,10	0,16	0,37
1 x 240	0,0754	0,102	0,102	0,10	0,16	0,41
1 x 300	0,0601	0,083	0,082	0,095	0,15	0,46
1 x 400	0,0470	0,066	0,065	0,093	0,15	0,49
1 x 500	0,0366	0,052	0,052	0,089	0,13	0,56
1 x 630	0,0283	0,042	0,039	0,087	0,13	0,62

RG26H1M16 - 18/30 kV
 U₀/U: 18/30 kV
 U max: 36 kV

RG26H1M16-18/30 kV / Technical characteristics

Formation	Approx. conductor Ø	Average insulation thickness	Average sheath thickness	Approx. external Ø	Approx. cable weight	Current rating A			
						in air		buried*	
						trefoil	flat	trefoil	flat
1 x 35	7,0	7,7	1,9	31,8	940	215	248	200	206
1 x 50	8,1	7,7	2,0	32,9	1450	256	290	231	240
1 x 70	9,7	7,1	2,0	33,3	1640	319	360	284	294
1 x 95	11,4	6,7	2,0	34,2	1900	389	441	339	351
1 x 120	13,0	6,4	2,0	35,2	2150	449	507	387	400
1 x 150	14,3	6,2	2,1	36,1	2440	506	576	432	448
1 x 185	16,0	6,0	2,1	37,4	2825	582	661	489	507
1 x 240	18,3	6,0	2,2	39,7	3420	689	775	567	583
1 x 300	20,6	6,1	2,3	42,6	4140	790	884	640	654
1 x 400	23,4	6,2	2,4	45,6	5165	915	1063	727	758
1 x 500	26,6	6,3	2,5	49,0	6240	1060	1237	825	861
1 x 630	30,1	6,4	2,5	52,7	7665	1220	1424	930	974

(*) Permissible current rating values are according to:
 - ground thermal resistivity: 1,0 K·m/W
 - ambient temperature 20°C
 - laying depth of 0,8 m for buried cables

RG26H1M16-18/30 kV / Technical characteristics

Formation	Max. electrical resistance at 20°C	Conductor apparent resistance at 105°C and 50Hz		Phase reactance Ω/km		Capacity at 50Hz
		Ω/km	trefoil	flat	trefoil	
1 x 35	0,524	0,665	0,665	0,13	0,20	0,13
1 x 50	0,387	0,516	0,516	0,14	0,20	0,15
1 x 70	0,268	0,358	0,358	0,13	0,19	0,17
1 x 95	0,193	0,258	0,258	0,12	0,18	0,19
1 x 120	0,153	0,205	0,205	0,12	0,18	0,22
1 x 150	0,124	0,166	0,166	0,11	0,17	0,24
1 x 185	0,0991	0,133	0,133	0,11	0,17	0,27
1 x 240	0,0754	0,102	0,102	0,10	0,16	0,30
1 x 300	0,0601	0,082	0,082	0,10	0,16	0,34
1 x 400	0,0470	0,065	0,065	0,0999	0,16	0,38
1 x 500	0,0366	0,053	0,052	0,095	0,15	0,42
1 x 630	0,0283	0,043	0,041	0,093	0,15	0,47

C A B L E S F O R A M O V I N G W O R L D

TRATOS[®] ENERGY DNOs

Tratos Utility cables are designed and tested to meet relevant UK, European and International standards. Manufactured in state of the art manufacturing facilities, the company's purpose-built, in-house Fire, Chemical, Electrical and Physical testing facilities and laboratories deliver peace of mind to customers ensuring their choice of Utility cable products meet all statutory and regulatory requirements.



www.tratosgroup.com



RG26H1M16X-12/20 kV | RG26H1M16X-18/30 kV cable

SLIMPOWER PLUS HT 105 TRATOS RG26H1M16X-12/20 kV TRATOS RG26H1M16X-18/30 kV

Suitable for energy transmission between transformer rooms and big power users; mostly suitable for premises with fire risk, and places where appliances, electrical (switch) boxes and instruments are operating and whose safeguard is fundamental. For laying on air, into tube or open pass. In case of UV exposure, appropriate protection is required. Can be laid underground, complying with art. 4.3.11 of CEI 11-17 standard.

Reference Construction Products Regulation 305/2011 EU and Standard EN 50575:

The cable is suitable for the supply of electricity in buildings and other civil engineering works.

FEATURES AND PERFORMANCES

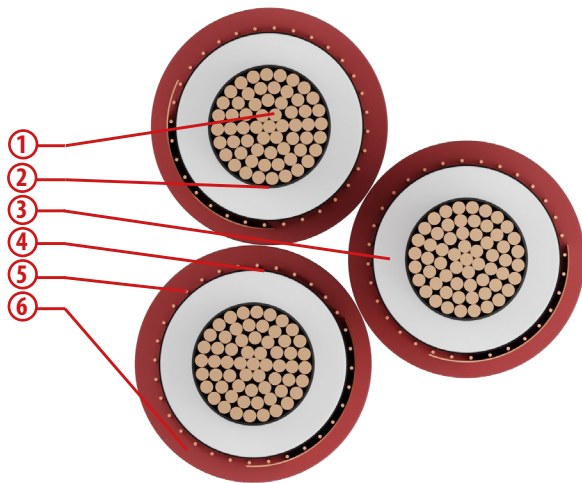

CONSTRUCTION

Bundled three-core cables, insulated with HEPR rubber of G26 quality, with reduced thickness and maximum operating temperature of 105°C. In case of high temperature is allowed a 10% overload in continuous operation and/or higher margins in critical situations than traditional cables.

1. CLASS 2, COMPACT STRANDED WIRE, PLAIN COPPER
2. SEMICONDUCTOR LAYER: EXTRUDED
3. RUBBER COMPOUND, G26 QUALITY, PB FREE (HD 620 DIH 2)
4. SEMICONDUCTOR LAYER: EXTRUDED, COLD STRIPPING
5. PLAIN COPPER WIRES WITH HELICALLY WOUNDED COPPER TAPE
6. LS0H THERMOPLASTIC, M16 QUALITY

LS0H = Low Smoke Zero Halogen

**Structure and electrical, physical, mechanical requirements: CEI UNEL 35334 according to IEC 60502
CEI 20-13 HD 620**

- Resistance to hydrocarbons CEI 20-34/0-1

Cable Marking

Pb free Tratos RG26H1M16 SLIMPOWER PLUS HT105 12/20 kV Cca-s1b,d1,a1 [form] [year] [traceability] [metric] FASE 1/2/3

Pb free Tratos RG26H1M16 SLIMPOWER PLUS HT105 18/30 kV Cca-s1b,d1,a1 [form] [year] [traceability] [metric] FASE 1/2/3

Functional characteristics

Rated voltage U ₀ /U	RG26H1M16X-12/20 kV: 12/20 kV RG26H1M16X-18/30 kV: 18/30 kV
Max operating voltage U _m	RG26H1M16X-12/20 kV: 24 kV RG26H1M16X-18/30 kV: 36 kV
Max. operating temperature	105°C
Min. operating temperature	-15°C (without mechanical shocks)
Max. short circuit temperature	300°C

Installation conditions

Minimum installation temperature	0°C
Recommended min. bending radius	21 times the cable diameter
Recommended maximum tensile stress	60 N/mm ² of the cross-section of the copper

RG26H1M16 - 12/20 kV

U_o/U: 12/20 kV

U max: 24 kV

RG26H1M16X-12/20 kV / Technical characteristics

Formation n° x mm ²	Approx. conductor ∅ mm	Approx. insulation ∅ mm	Approx. external ∅ mm	Approx. cable weight kg/km	Current rating A	
					in air	buried*
					A	A
3 x 1 x 25	5,9	24,3	52,5	2455	175	166
3 x 1 x 35	7,0	25,4	54,9	2820	212	199
3 x 1 x 50	8,1	26,1	56,3	3200	253	235
3 x 1 x 70	9,7	27,3	58,9	3870	316	288
3 x 1 x 95	11,4	28,8	62,2	4710	385	345
3 x 1 x 120	13,0	30,4	65,7	5535	445	392
3 x 1 x 150	14,3	31,9	69,0	6490	506	440
3 x 1 x 185	16,0	33,8	73,1	7640	581	496
3 x 1 x 240	18,3	36,1	77,9	9490	688	574
3 x 1 x 300	20,6	39,0	84,3	11655	790	647
3 x 1 x 400	23,4	42,0	90,8	14260	914	730

(*) Permissible current rating values are according to:

- ground thermal resistivity: 1,0 K-m/W

- ambient temperature 20°C

- laying depth of 0,8 m for buried cables

RG26H1M16X-12/20 kV / Electrical characteristics

Formation n° x mm ²	Max. electrical resistance at 20°C Ω/km	Conductor apparent resistance at 105°C and 50Hz Ω/km	Phase reactance Ω/km	Capacity at 50Hz μF/km
3 x 1 x 25	0,727	0,970	0,14	0,17
3 x 1 x 35	0,524	0,669	0,13	0,20
3 x 1 x 50	0,387	0,517	0,13	0,22
3 x 1 x 70	0,268	0,358	0,12	0,25
3 x 1 x 95	0,193	0,258	0,11	0,29
3 x 1 x 120	0,153	0,205	0,11	0,31
3 x 1 x 150	0,124	0,166	0,11	0,34
3 x 1 x 185	0,0991	0,134	0,10	0,37
3 x 1 x 240	0,0754	0,102	0,10	0,41
3 x 1 x 300	0,0601	0,083	0,095	0,46
3 x 1 x 400	0,0470	0,066	0,093	0,49

RG26H1M16 - 18/30 kV
 U₀/U: 12/20 kV
 U max: 24 kV

RG26H1M16X-18/30 kV / Technical characteristics

Formation n° x mm ²	Approx. conductor Ø mm	Approx. insulation Ø mm	Approx. external Ø mm	Approx. cable weight kg/km	Current rating A	
					in air	buried*
					A	A
3 x 1 x 35	7,0	31,8	68,7	3880	215	200
3 x 1 x 50	8,1	32,9	71,0	4365	256	231
3 x 1 x 70	9,7	33,3	71,9	4940	319	284
3 x 1 x 95	11,4	34,2	73,8	5725	389	339
3 x 1 x 120	13,0	35,2	76,1	6475	449	387
3 x 1 x 150	14,3	36,1	78,0	7350	506	432
3 x 1 x 185	16,0	37,4	80,8	8510	582	489
3 x 1 x 240	18,3	39,7	85,7	10310	689	567
3 x 1 x 300	20,6	42,6	92,1	12472	790	640

(*) Permissible current rating values are according to:
 - ground thermal resistivity: 1,0 K-m/W
 - ambient temperature 20°C
 - laying depth of 0,8 m for buried cables

RG26H1M16X-18/30 kV / Electrical characteristics

Formation n° x mm ²	Max. electrical resistance at 20°C Ω/km	Conductor apparent resistance at 105°C and 50Hz Ω/km	Phase reactance Ω/km	Capacity at 50Hz µF/km
3 x 1 x 35	0,524	0,669	0,13	0,20
3 x 1 x 50	0,387	0,516	0,13	0,22
3 x 1 x 70	0,268	0,358	0,12	0,25
3 x 1 x 95	0,193	0,258	0,11	0,29
3 x 1 x 120	0,153	0,205	0,11	0,31
3 x 1 x 150	0,124	0,166	0,11	0,34
3 x 1 x 185	0,0991	0,133	0,10	0,37
3 x 1 x 240	0,0754	0,102	0,10	0,41
3 x 1 x 300	0,0601	0,083	0,095	0,46

C A B L E S F O R A M O V I N G W O R L D

TRATOS[®] ENERGY DNOs

Tratos Utility cables are designed and tested to meet relevant UK, European and International standards. Manufactured in state of the art manufacturing facilities, the company's purpose-built, in-house Fire, Chemical, Electrical and Physical testing facilities and laboratories deliver peace of mind to customers ensuring their choice of Utility cable products meet all statutory and regulatory requirements.



www.tratosgroup.com



ARG7H1M1 cable

SLIMPOWER HT 105 TRATOS ARG7H1M1-12/20 kV TRATOS ARG7H1M1-18/30 kV

Suitable for energy transmission between transformer rooms and big power users; mostly suitable for premises with fire risk, and places where appliances, electrical (switch) boxes and instruments are operating and whose safeguard is fundamental. Can be laid underground, complying with art. 4.3.11 of CEI 11-17 standard.

FEATURES AND PERFORMANCES

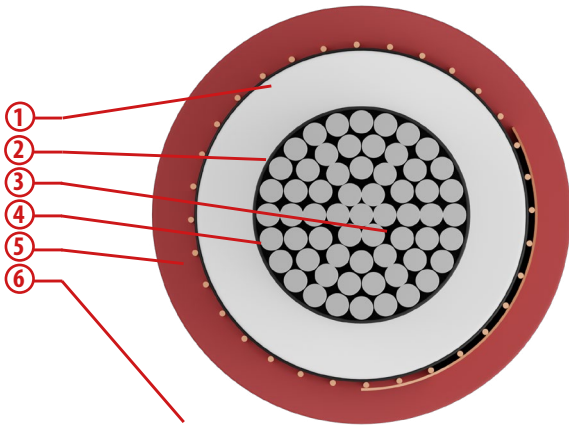

CONSTRUCTION

Single-core cables are insulated with HEPR rubber of G7 quality, with reduced thickness and maximum operating temperature of 105°C. In case of high temperature is allowed a 10% overload in continuous operation and/or higher margins in critical situations than traditional cables.

1. CLASS 2, COMPACT STRANDED WIRE, ALUMINUM
2. SEMICONDUCTOR LAYER: EXTRUDED
3. (REDUCED THICKNESS) RUBBER COMPOUND, G7 QUALITY, PB FREE (HD 620 DHI 2)
4. SEMICONDUCTOR LAYER: EXTRUDED, COLD STRIPPING
5. PLAIN COPPER WIRES WITH HELICALLY WOUNDED COPPER TAPE
6. LS0H THERMOPLASTIC, M1 QUALITY

LS0H = Low Smoke Zero Halogen

N.B. The cable can be built in the three-pole version with helically wound cores. In this case, the initials becomes ARG7H1M1X followed by rated voltage.

Structure and electrical, physical, mechanical requirements: according to IEC 60502 according to CEI 20-13 HD 620

- **Fire propagation** EN 60332-3-24 (CEI 20-22 III)
- **Flame propagation** EN 60332-1-2
- **Corrosive gases or halogens** EN 50267-2-1
- **Smoke density (transmittance)** EN 61034-2
- **Resistance to hydrocarbons** CEI 20-34/0-1

Cable Marking

Pb free CEI 20-22 III CAT. C Tratos ARG7H1M1 SLIMPOWER HT105 12/20 kV [form] [year] [traceability] [metric]

Pb free CEI 20-22 III CAT. C Tratos ARG7H1M1 SLIMPOWER HT105 18/30 kV [form] [year] [traceability] [metric]

Installation conditions	
Minimum installation temperature	0°C
Recommended min. bending radius	12 times the cable diameter
Recommended maximum tensile stress	60 N/mm ² of the cross-section of the copper

Functional characteristics	
Rated voltage U ₀ /U	ARG7H1M1-12/20 kV: 12/20 kV ARG7H1M1-18/30 kV: 18/30 kV
Max operating voltage U _m	ARG7H1M1-12/20 kV: 24 kV ARG7H1M1-18/30 kV: 36 kV
Max. operating temperature	105°C
Min. operating temperature	-15°C (without mechanical shocks)
Max. short circuit temperature	300°C

ARG7H1M1 - 12/20 kV
 U₀/U: 12/20 kV
 U max: 24 kV

ARG7H1M1-12/20 kV / Technical characteristics

Formation n° x mm ²	Approx. conductor Ø mm	Approx. Insulation Ø mm	Max. external Ø mm	Approx. cable weight kg/km	Current rating A			
					in air		buried*	
					trefoil	flat	trefoil	flat
1 x 25	6,1	16,90	23,75	605	96	110	124	129
1 x 35	7,1	17,30	24,15	634	144	152	142	149
1 x 50	8,2	18,00	24,85	691	174	183	168	177
1 x 70	9,8	19,2	26,10	769	218	229	207	218
1 x 95	11,4	20,85	27,70	885	266	280	247	260
1 x 120	12,9	22,30	29,40	1021	309	325	281	296
1 x 150	14,3	23,60	30,70	1137	352	371	318	335
1 x 185	16,0	25,40	32,70	1307	406	427	361	380
1 x 240	18,3	27,80	35,15	1533	483	508	418	440
1 x 300	21,0	30,30	37,90	1800	547	576	472	497
1 x 400	23,6	33,40	41,00	2292	640	674	543	572
1 x 500	26,5	36,35	44,40	2635	740	779	621	654
1 x 630	30,1	39,90	48,20	3181	862	907	706	743

* Ground thermal resistivity 100°C cm/W

ARG7H1M1-12/20 kV / Electrical characteristics

Formation n° x mm ²	Max. electrical resistance at 20°C Ω/km	Conductor apparent resistance at 105°C and 50Hz Ω/km		Phase reactance Ω/km		Capacity at 50Hz μF/km
		trefoil	flat	trefoil	flat	
1 x 25	1,200	1,402	1,402	0,16	0,22	0,13
1 x 35	0,868	1,113	1,113	0,16	0,21	0,15
1 x 50	0,641	0,822	0,822	0,15	0,20	0,15
1 x 70	0,443	0,568	0,568	0,14	0,20	0,16
1 x 95	0,320	0,411	0,411	0,13	0,19	0,18
1 x 120	0,253	0,325	0,325	0,13	0,18	0,19
1 x 150	0,206	0,265	0,265	0,12	0,18	0,20
1 x 185	0,164	0,211	0,211	0,12	0,18	0,22
1 x 240	0,125	0,161	0,161	0,11	0,17	0,24
1 x 300	0,100	0,130	0,129	0,11	0,17	0,27
1 x 400	0,0778	0,102	0,101	0,11	0,16	0,29
1 x 500	0,0605	0,0801	0,0794	0,10	0,16	0,32
1 x 630	0,0469	0,0635	0,0635	0,099	0,16	0,36

ARG7H1M1 - 18/30 kV
 U₀/U: 18/30 kV
 U max: 36 kV

ARG7H1M1-18/30 kV / Technical characteristics

Formation n° x mm ²	Approx. conductor Ø mm	Approx. Insulation Ø mm	Approx. external Ø mm	Approx. cable weight kg/km	Current rating A			
					in air		buried*	
					trefoil	flat	trefoil	flat
1 x 50	8,2	25,7	32,20	1081	174	183	168	177
1 x 70	9,8	26,0	32,50	1135	218	229	207	218
1 x 95	11,4	27,05	33,60	1233	266	280	247	260
1 x 120	12,9	27,9	34,45	1332	309	325	281	296
1 x 150	14,3	29,0	35,75	1460	352	371	318	335
1 x 185	16,0	30,2	36,95	1589	406	427	361	380
1 x 240	18,3	32,2	39,20	1824	483	508	418	440
1 x 300	21,0	34,7	41,90	2107	547	576	472	497
1 x 400	23,6	37,8	45,25	2650	640	674	543	572
1 x 500	26,5	40,75	48,45	2999	740	779	621	654
1 x 630	30,1	44,3	52,20	3568	862	907	706	743

* Ground thermal resistivity 100°C cm/W

ARG7H1M1-18/30 kV / Electrical characteristics

Formation n° x mm ²	Max. electrical resistance at 20°C Ω/km	Conductor apparent resistance at 105°C and 50Hz Ω/km		Phase reactance Ω/km		Capacity at 50Hz µF/km
		trefoil	flat	trefoil	flat	
1 x 50	0,641	0,822	0,822	0,15	0,20	0,15
1 x 70	0,443	0,568	0,568	0,14	0,20	0,16
1 x 95	0,320	0,411	0,411	0,13	0,19	0,18
1 x 120	0,253	0,325	0,325	0,13	0,18	0,19
1 x 150	0,206	0,265	0,265	0,12	0,18	0,20
1 x 185	0,164	0,211	0,211	0,12	0,18	0,22
1 x 240	0,125	0,161	0,161	0,11	0,17	0,24
1 x 300	0,100	0,129	0,129	0,11	0,17	0,27
1 x 400	0,0778	0,102	0,101	0,11	0,16	0,29
1 x 500	0,0605	0,0801	0,0794	0,10	0,16	0,32
1 x 630	0,0469	0,0635	0,0625	0,099	0,16	0,36

C A B L E S F O R A M O V I N G W O R L D

TRATOS[®] ENERGY DNOs

Tratos Utility cables are designed and tested to meet relevant UK, European and International standards. Manufactured in state of the art manufacturing facilities, the company's purpose-built, in-house Fire, Chemical, Electrical and Physical testing facilities and laboratories deliver peace of mind to customers ensuring their choice of Utility cable products meet all statutory and regulatory requirements.



www.tratosgroup.com



RG16H1R12 | RG16H1OR12 cable

TRATOS RG16H1R12-1,8/3 kV ÷ 26/45 kV TRATOS RG16H1OR12-1,8/3 kV ÷ 26/45 kV

Suitable for energy transmission between transformer rooms and big power users. For laying on air, into tube or open pass. Can be laid underground, also if not protected, complying with art. 4.3.11 of CEI 11-17 standard.

Reference Construction Products Regulation 305/2011 EU and Standard EN 50575:
The cable is suitable for the supply of electricity in buildings and other civil engineering works.

FEATURES AND PERFORMANCES

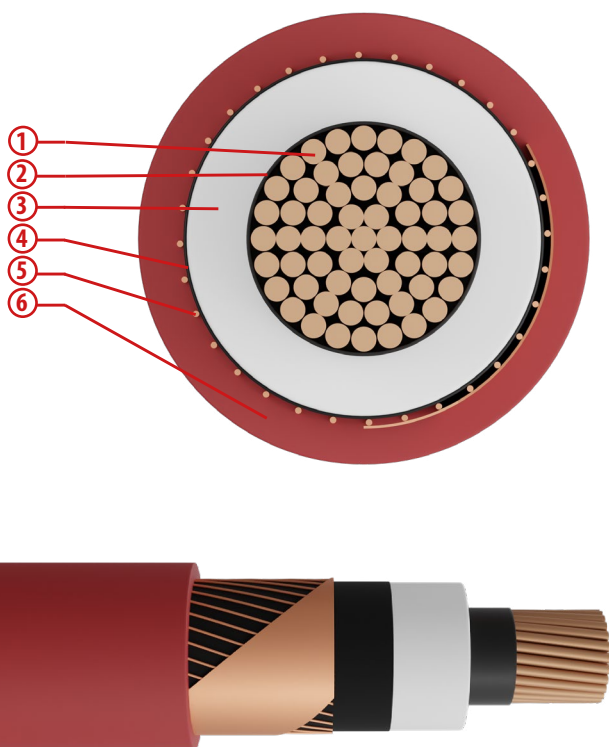

CONSTRUCTION

RG16H1R12

Single-core cables, insulated with HEPR rubber of G16 quality, under PVC sheath.

RG16H1OR12

Three-pole cables, insulated with HEPR rubber of G16 quality, under PVC sheath.

1. CLASS 2, COMPACT STRANDED WIRE, PLAIN COPPER
2. SEMICONDUCTOR LAYER: EXTRUDED (ONLY CABLES UO/U ≥ 6/10 KV)
3. HEPR RUBBER, G16 QUALITY, PB FREE
4. SEMICONDUCTOR LAYER: EXTRUDED, COLD STRIPPING (ONLY CABLES UO/U ≥ 6/10 KV)
5. PLAIN COPPER TAPES WRAPPED
6. PVC BASED COMPOUND, R12 QUALITY

N.B. The cable can be built in the three-pole version with helically wound cores. In this case, the initials becomes RG16H1R12X, followed by rated voltage.

Structure and electrical, physical, mechanical requirements: CEI 20-13 CEI 20-66 IEC 60502-2

• Measurement of partial discharges	CEI 20-16 IEC 60885-3
-------------------------------------	--------------------------

Special features

Resistance to UV rays.
(ISO 4892-2:2013 / IEC 60811-501:2012 / 1000h)

Cable Marking

Pb free Tratos RG16H1(O)R12 [rated voltage] [form.] Eac [year] [traceability] (CEI logo) [metric]

Installation conditions

Minimum installation temperature	0°C
Recommended min. bending radius	14 times the cable diameter
Recommended maximum tensile stress	60 N/mm ² of the cross-section of the copper

Functional characteristics

Rated voltage U ₀ /U	1,8/3 - 26/45 kV
Max. operating temperature	90°C
Min. operating temperature	-15°C (without mechanical shocks)
Max. short circuit temperature	250°C

RG16H1R12 - 1,8/3 kV
 U₀/U: 1,8/3 kV
 U max: 3,6 kV

Technical characteristics

Formation n° x mm ²	Approx. conductor Ø mm	Average insulation thickness mm	Approx. external Ø mm	Approx. cable weight kg/km	Current rating A			
					in air		buried*	
					trefoil	flat	trefoil	flat
1 x 10	4,0	2,0	12,8	300	87	111	99	104
1 x 16	4,8	2,0	13,6	365	114	145	126	133
1 x 25	6,0	2,0	14,8	470	149	190	162	171
1 x 35	7,0	2,0	15,9	580	181	230	193	204
1 x 50	8,1	2,0	17,0	700	219	276	227	241
1 x 70	9,7	2,0	18,6	920	275	345	278	294
1 x 95	11,4	2,0	20,3	1190	339	422	332	351
1 x 120	12,9	2,0	21,9	1440	393	487	377	399
1 x 150	14,3	2,0	23,3	1720	446	550	421	445
1 x 185	16,0	2,0	25,0	2065	516	635	477	500
1 x 240	18,3	2,0	27,1	2640	617	745	550	580
1 x 300	21,0	2,0	30,1	3310	709	855	621	650
1 x 400	23,2	2,0	32,5	4125	824	990	702	735
1 x 500	26,1	2,2	36,7	5250	954	1140	790	830
1 x 630	30,3	2,4	41,1	6760	1102	1300	885	930

(*) Permissible current rating values are according to:
 - ground thermal resistivity: 1,0 K-m/W
 - ambient temperature 20°C
 - laying depth of 0,8 m for buried cables

Electrical characteristics

Formation n° x mm ²	Max. electrical resistance at 20°C Ω/km	Conductor apparent resistance at 90°C and 50Hz Ω/km		Phase reactance Ω/km		Capacity at 50Hz µF/km
		trefoil	flat	trefoil	flat	
1 x 10	1,83	2,34	2,34	0,13	0,19	0,19
1 x 16	1,15	1,47	1,47	0,12	0,18	0,23
1 x 25	0,727	0,927	0,927	0,12	0,18	0,27
1 x 35	0,524	0,669	0,668	0,11	0,17	0,30
1 x 50	0,387	0,494	0,494	0,11	0,16	0,34
1 x 70	0,268	0,342	0,342	0,10	0,16	0,40
1 x 95	0,193	0,246	0,246	0,098	0,16	0,45
1 x 120	0,153	0,196	0,196	0,095	0,15	0,50
1 x 150	0,124	0,159	0,158	0,092	0,15	0,55
1 x 185	0,0991	0,128	0,127	0,089	0,15	0,60
1 x 240	0,0754	0,0985	0,0974	0,086	0,14	0,68
1 x 300	0,0601	0,0797	0,0781	0,084	0,14	0,75
1 x 400	0,0470	0,0638	0,0628	0,083	0,14	0,83
1 x 500	0,0366	0,0517	0,0492	0,081	0,14	0,88
1 x 630	0,0283	0,0425	0,0392	0,079	0,14	0,92

TRATOS General Cables®

RG16H1R12 - 3,6/6 kV

U₀/U: 3,6/6 kV

U max: 7,2 kV

Technical characteristics

Formation	Approx. conductor Ø	Average insulation thickness	Approx. external Ø	Approx. cable weight	Current rating A			
					in air		buried*	
					trefoil	flat	trefoil	flat
n° x mm ²	mm	mm	mm	kg/km				
1 x 10	4,0	3,0	14,8	365	87	105	95	100
1 x 16	4,8	3,0	15,6	435	113	136	122	128
1 x 25	6,0	3,0	16,8	550	150	180	156	165
1 x 35	7,0	3,0	17,9	660	182	220	187	197
1 x 50	8,1	3,0	19,0	795	219	261	220	233
1 x 70	9,7	3,0	20,6	1015	275	328	271	286
1 x 95	11,4	3,0	22,3	1295	337	402	324	342
1 x 120	12,9	3,0	23,9	1550	390	465	370	390
1 x 150	14,3	3,0	25,3	1840	443	525	412	435
1 x 185	16,0	3,0	27,0	2190	512	605	468	491
1 x 240	18,3	3,0	29,3	2790	608	715	540	570
1 x 300	21,0	3,0	32,3	3465	700	820	610	640
1 x 400	23,2	3,0	34,7	4280	813	950	690	725
1 x 500	26,1	3,2	38,9	5430	940	1100	780	820
1 x 630	30,3	3,2	42,7	6910	1082	1260	875	915

(*) Permissible current rating values are according to:

- ground thermal resistivity: 1,0 K·m/W

- ambient temperature 20°C

- laying depth of 0,8 m for buried cables

Electrical characteristics

Formation	Max. electrical resistance at 20°C	Conductor apparent resistance at 90°C and 50Hz		Phase reactance		Capacity at 50Hz
		Ω/km		Ω/km		
n° x mm ²	Ω/km	trefoil	flat	trefoil	flat	μF/km
1 x 10	1,83	2,34	2,34	0,14	0,20	0,15
1 x 16	1,15	1,47	1,47	0,14	0,19	0,17
1 x 25	0,727	0,927	0,927	0,13	0,18	0,20
1 x 35	0,524	0,669	0,668	0,12	0,18	0,23
1 x 50	0,387	0,494	0,494	0,11	0,17	0,25
1 x 70	0,268	0,342	0,342	0,11	0,17	0,29
1 x 95	0,193	0,246	0,246	0,10	0,16	0,33
1 x 120	0,153	0,196	0,196	0,10	0,16	0,37
1 x 150	0,124	0,159	0,158	0,097	0,16	0,40
1 x 185	0,0991	0,128	0,127	0,094	0,15	0,44
1 x 240	0,0754	0,0985	0,0974	0,091	0,15	0,49
1 x 300	0,0601	0,0797	0,0781	0,089	0,15	0,54
1 x 400	0,0470	0,0638	0,0628	0,087	0,15	0,60
1 x 500	0,0366	0,0517	0,0492	0,084	0,14	0,64
1 x 630	0,0283	0,0425	0,0392	0,082	0,14	0,72

RG16H1R12 - 6/10 kV
 U₀/U: 6/10 kV
 U max: 12 kV

Technical characteristics

Formation n° x mm ²	Approx. conductor Ø mm	Average insulation thickness mm	Approx. external Ø mm	Approx. cable weight kg/km	Current rating A			
					in air		buried*	
					trefoil	flat	trefoil	flat
1 x 10	4,0	3,4	18,6	460	91	105	93	98
1 x 16	4,8	3,4	19,4	535	117	136	122	128
1 x 25	6,0	3,4	20,6	650	154	105	155	163
1 x 35	7,0	3,4	21,6	760	186	219	185	195
1 x 50	8,1	3,4	22,7	905	223	260	218	231
1 x 70	9,7	3,4	24,3	1190	279	325	270	285
1 x 95	11,4	3,4	26,0	1420	340	398	320	340
1 x 120	12,9	3,4	27,8	1695	395	460	365	385
1 x 150	14,3	3,4	29,4	2015	448	520	410	432
1 x 185	16,0	3,4	31,1	2380	516	600	464	490
1 x 240	18,3	3,4	33,9	3015	610	705	540	565
1 x 300	21,0	3,4	36,6	3705	703	810	605	635
1 x 400	23,2	3,4	39,8	4595	815	935	690	720
1 x 500	26,1	3,4	43,4	5740	945	1080	780	810
1 x 630	30,3	3,4	47,7	7280	1085	1230	875	900

(*) Permissible current rating values are according to:

- ground thermal resistivity: 1,0 K-m/W
- ambient temperature 20°C
- laying depth of 0,8 m for buried cables

Electrical characteristics

Formation n° x mm ²	Max. electrical resistance at 20°C Ω/km	Conductor apparent resistance at 90°C and 50Hz Ω/km		Phase reactance Ω/km		Capacity at 50Hz μF/km
		trefoil	flat	trefoil	flat	
1 x 10	1,83	2,34	2,34	0,16	0,21	0,16
1 x 16	1,15	1,47	1,47	0,15	0,20	0,18
1 x 25	0,727	0,927	0,927	0,14	0,19	0,21
1 x 35	0,524	0,669	0,669	0,13	0,19	0,23
1 x 50	0,387	0,494	0,494	0,12	0,18	0,26
1 x 70	0,268	0,342	0,342	0,12	0,17	0,29
1 x 95	0,193	0,246	0,246	0,11	0,17	0,32
1 x 120	0,153	0,196	0,196	0,11	0,16	0,36
1 x 150	0,124	0,159	0,158	0,10	0,16	0,38
1 x 185	0,0991	0,128	0,127	0,10	0,16	0,42
1 x 240	0,0754	0,0985	0,0973	0,097	0,16	0,47
1 x 300	0,0601	0,0797	0,0780	0,095	0,15	0,52
1 x 400	0,0470	0,0638	0,0617	0,092	0,15	0,57
1 x 500	0,0366	0,0517	0,0490	0,089	0,15	0,64
1 x 630	0,0283	0,0425	0,0390	0,087	0,15	0,73

TRATOS General Cables®

RG16H1R12 - 8,7/15 kV
 U₀/U: 8,7/15 kV
 U max: 17,5 kV

Technical characteristics

Formation n° x mm ²	Approx. conductor Ø mm	Average insulation thickness mm	Approx. external Ø mm	Approx. cable weight kg/km	Current rating A			
					in air		buried*	
					trefoil	flat	trefoil	flat
1 x 16	4,8	4,5	21,6	620	120	135	118	123
1 x 25	6,0	4,5	22,8	745	155	177	152	158
1 x 35	7,0	4,5	23,8	865	190	215	181	190
1 x 50	8,1	4,5	24,9	1010	225	258	213	224
1 x 70	9,7	4,5	26,5	1250	282	323	262	276
1 x 95	11,4	4,5	28,2	1540	345	393	313	330
1 x 120	12,9	4,5	30,2	1840	400	455	358	375
1 x 150	14,3	4,5	31,8	2170	450	515	396	420
1 x 185	16,0	4,5	33,7	2550	518	590	453	475
1 x 240	18,3	4,5	36,3	3190	615	700	525	550
1 x 300	21,0	4,5	39,4	3930	704	800	590	620
1 x 400	23,2	4,5	42,2	4805	816	920	670	700
1 x 500	26,1	4,5	45,8	5950	945	1060	760	785
1 x 630	30,3	4,5	49,9	7505	1088	1210	850	870

(*) Permissible current rating values are according to:
 - ground thermal resistivity: 1,0 K·m/W
 - ambient temperature 20°C
 - laying depth of 0,8 m for buried cables

Electrical characteristics

Formation n° x mm ²	Max. electrical resistance at 20°C Ω/km	Conductor apparent resistance at 90°C and 50Hz Ω/km		Phase reactance Ω/km		Capacity at 50Hz μF/km
		trefoil	flat	trefoil	flat	
1 x 16	1,15	1,47	1,47	0,15	0,21	0,15
1 x 25	0,727	0,927	0,927	0,14	0,20	0,18
1 x 35	0,524	0,669	0,669	0,14	0,19	0,19
1 x 50	0,387	0,494	0,494	0,13	0,19	0,21
1 x 70	0,268	0,342	0,342	0,12	0,18	0,24
1 x 95	0,193	0,246	0,246	0,12	0,17	0,26
1 x 120	0,153	0,196	0,196	0,11	0,17	0,29
1 x 150	0,124	0,159	0,158	0,11	0,17	0,31
1 x 185	0,0991	0,128	0,127	0,11	0,16	0,34
1 x 240	0,0754	0,0985	0,0973	0,10	0,16	0,37
1 x 300	0,0601	0,0797	0,0780	0,099	0,16	0,42
1 x 400	0,0470	0,0638	0,0617	0,096	0,15	0,45
1 x 500	0,0366	0,0517	0,0490	0,092	0,15	0,51
1 x 630	0,0283	0,0425	0,0390	0,090	0,15	0,58

RG16H1R12 - 12/20 kV
 U_o/U: 12/20 kV
 U max: 24 kV

Technical characteristics

Formation n° x mm ²	Approx. conductor Ø mm	Average insulation thickness mm	Approx. external Ø mm	Approx. cable weight kg/km	Current rating A			
					in air		buried*	
					trefoil	flat	trefoil	flat
1 x 25	6,0	5,5	24,8	840	158	176	153	158
1 x 35	7,0	5,5	25,8	965	190	213	182	189
1 x 50	8,1	5,5	26,9	1120	230	255	216	225
1 x 70	9,7	5,5	28,5	1365	285	320	265	275
1 x 95	11,4	5,5	30,4	1680	348	390	315	329
1 x 120	12,9	5,5	32,6	2000	400	450	360	374
1 x 150	14,3	5,5	34,1	2320	450	510	402	416
1 x 185	16,0	5,5	35,9	2710	520	585	455	472
1 x 240	18,3	5,5	38,9	3395	615	690	528	545
1 x 300	21,0	5,5	41,6	4110	705	790	595	611
1 x 400	23,2	5,5	44,2	4980	815	910	674	690
1 x 500	26,1	5,5	48,0	6175	945	1050	762	776
1 x 630	30,3	5,5	52,1	7740	1087	1190	858	875

(*) Permissible current rating values are according to:
 - ground thermal resistivity: 1,0 K-m/W
 - ambient temperature 20°C
 - laying depth of 0,8 m for buried cables

Electrical characteristics

Formation n° x mm ²	Max. electrical resistance at 20°C Ω/km	Conductor apparent resistance at 90°C and 50Hz Ω/km		Phase reactance Ω/km		Capacity at 50Hz μF/km
		trefoil	flat	trefoil	flat	
1 x 25	0,727	0,927	0,927	0,14	0,20	0,16
1 x 35	0,524	0,669	0,669	0,14	0,20	0,17
1 x 50	0,387	0,494	0,494	0,13	0,19	0,18
1 x 70	0,268	0,342	0,342	0,13	0,19	0,21
1 x 95	0,193	0,246	0,246	0,12	0,18	0,23
1 x 120	0,153	0,196	0,196	0,12	0,18	0,25
1 x 150	0,124	0,159	0,158	0,11	0,17	0,27
1 x 185	0,0991	0,128	0,127	0,11	0,17	0,29
1 x 240	0,0754	0,0985	0,0972	0,11	0,16	0,32
1 x 300	0,0601	0,0797	0,0779	0,10	0,16	0,35
1 x 400	0,0470	0,0638	0,0616	0,099	0,16	0,39
1 x 500	0,0366	0,0517	0,0489	0,096	0,15	0,43
1 x 630	0,0283	0,0425	0,0389	0,093	0,15	0,49

TRATOS General Cables®

RG16H1R12 - 18/30 kV

U₀/U: 18/30 kV

U max: 36 kV

Technical characteristics

Formation	Approx. conductor Ø	Average insulation thickness	Approx. external Ø	Approx. cable weight	Current rating A			
					in air		buried*	
					trefoil	flat	trefoil	flat
1 x 35	7,0	8,0	31,0	1310	191	212	182	188
1 x 50	8,1	8,0	32,5	1470	229	254	214	222
1 x 70	9,7	8,0	34,1	1730	285	316	263	272
1 x 95	11,4	8,0	36,0	2065	347	387	314	325
1 x 120	12,9	8,0	38,4	2425	401	445	358	370
1 x 150	14,3	8,0	39,9	2760	452	505	400	415
1 x 185	16,0	8,0	41,7	3105	520	580	453	469
1 x 240	18,3	8,0	44,3	3860	615	680	525	540
1 x 300	21,0	8,0	46,8	4585	705	775	593	606
1 x 400	23,2	8,0	49,6	5505	815	895	671	685
1 x 500	26,1	8,0	53,4	6745	943	1030	761	775
1 x 630	30,3	8,0	57,5	8345	1085	1170	850	875

(*) Permissible current rating values are according to:

- ground thermal resistivity: 1,0 K-m/W
- ambient temperature 20°C
- laying depth of 0,8 m for buried cables

Electrical characteristics

Formation	Max. electrical resistance at 20°C	Conductor apparent resistance at 90°C and 50Hz		Phase reactance		Capacity at 50Hz
		Ω/km		Ω/km		
n° x mm ²	Ω/km	trefoil	flat	trefoil	flat	μF/km
1 x 35	0,524	0,669	0,669	0,15	0,20	0,14
1 x 50	0,387	0,494	0,494	0,15	0,20	0,15
1 x 70	0,268	0,342	0,342	0,14	0,20	0,16
1 x 95	0,193	0,246	0,246	0,13	0,19	0,18
1 x 120	0,153	0,196	0,196	0,13	0,18	0,19
1 x 150	0,124	0,159	0,158	0,12	0,18	0,20
1 x 185	0,0991	0,128	0,127	0,12	0,18	0,22
1 x 240	0,0754	0,0985	0,0972	0,11	0,17	0,24
1 x 300	0,0601	0,0797	0,0779	0,11	0,17	0,27
1 x 400	0,0470	0,0638	0,0616	0,11	0,16	0,29
1 x 500	0,0366	0,0517	0,0489	0,10	0,16	0,32
1 x 630	0,0283	0,0425	0,0389	0,099	0,16	0,36

RG16H1OR12 - 1,8/3 kV
 U_o/U: 1,8/3 kV
 U max: 3,6 kV

Technical characteristics

Formation	Approx. conductor Ø	Average insulation thickness	Approx. external Ø	Approx. cable weight	Current rating A	
					n° x mm ²	mm
3 x 10	4,0	2,0	22,7	895	85	93
3 x 16	4,8	2,0	24,0	1135	190	120
3 x 25	6,0	2,0	26,5	1520	145	155
3 x 35	7,0	2,0	29,0	1880	175	185
3 x 50	8,1	2,0	31,3	2330	208	216
3 x 70	9,7	2,0	35,2	3150	260	265
3 x 95	11,4	2,0	39,2	4100	318	315
3 x 120	12,9	2,0	42,8	5020	367	360
3 x 150	14,3	2,0	46,1	6040	415	400
3 x 185	16,0	2,0	49,9	7295	476	453
3 x 240	18,3	2,0	55,7	9355	555	520
3 x 300	21,0	2,0	61,5	11540	635	585
3 x 400	23,2	2,0	67,1	14650	716	651

(*) Permissible current rating values are according to:
 - ground thermal resistivity: 1,0 K-m/W
 - ambient temperature 20°C
 - laying depth of 0,8 m for buried cables

Electrical characteristics

Formation	Max. electrical resistance at 20°C	Conductor apparent resistance at 90°C and 50Hz	Phase reactance	Capacity at 50Hz
n° x mm ²	Ω/km	Ω/km	Ω/km	μF/km
3 x 10	1,83	2,34	0,11	0,19
3 x 16	1,15	1,47	0,10	0,23
3 x 25	0,727	0,927	0,097	0,27
3 x 35	0,524	0,669	0,093	0,30
3 x 50	0,387	0,494	0,088	0,34
3 x 70	0,268	0,342	0,084	0,40
3 x 95	0,193	0,247	0,081	0,45
3 x 120	0,153	0,197	0,079	0,50
3 x 150	0,124	0,159	0,077	0,55
3 x 185	0,0991	0,129	0,076	0,60
3 x 240	0,0754	0,0990	0,074	0,68
3 x 300	0,0601	0,0807	0,072	0,75
3 x 400	0,0470	0,0651	0,071	0,83

TRATOS General Cables®

RG16H1OR12 - 3,6/6 kV
 U₀/U: 3,6/6 kV
 U max: 7,2 kV

Technical characteristics

Formation	Approx. conductor Ø	Average insulation thickness	Approx. external Ø	Approx. cable weight	Current rating A		
					n° x mm ²	mm	mm
3 x 10	4,0	3,0	26,6	1180		85	93
3 x 16	4,8	3,0	28,5	1480		109	120
3 x 25	6,0	3,0	31,2	1875		145	153
3 x 35	7,0	3,0	33,5	2250		175	183
3 x 50	8,1	3,0	36,2	2790		211	216
3 x 70	9,7	3,0	39,9	3610		262	263
3 x 95	11,4	3,0	43,9	4590		318	315
3 x 120	12,9	3,0	47,7	5580		370	359
3 x 150	14,3	3,0	51,0	6640		415	400
3 x 185	16,0	3,0	54,8	7940		477	451
3 x 240	18,3	3,0	60,6	10060		555	518
3 x 300	21,0	3,0	66,4	12330		635	583
3 x 400	23,2	3,0	72,0	15490		717	651

(*) Permissible current rating values are according to:
 - ground thermal resistivity: 1,0 K·m/W
 - ambient temperature 20°C
 - laying depth of 0,8 m for buried cables

Electrical characteristics

Formation	Max. electrical resistance at 20°C	Conductor apparent resistance at 90°C and 50Hz	Phase reactance	Capacity at 50Hz
n° x mm ²	Ω/km	Ω/km	Ω/km	μF/km
3 x 10	1,83	2,34	0,12	0,15
3 x 16	1,15	1,47	0,12	0,17
3 x 25	0,727	0,927	0,11	0,20
3 x 35	0,524	0,669	0,10	0,23
3 x 50	0,387	0,494	0,097	0,26
3 x 70	0,268	0,342	0,092	0,30
3 x 95	0,193	0,247	0,089	0,33
3 x 120	0,153	0,197	0,086	0,37
3 x 150	0,124	0,159	0,084	0,40
3 x 185	0,0991	0,129	0,082	0,44
3 x 240	0,0754	0,0990	0,079	0,49
3 x 300	0,0601	0,0807	0,077	0,54
3 x 400	0,0470	0,0651	0,075	0,60

RG16H1OR12 - 6/10 kV
 U₀/U: 6/10 kV
 U max: 12 kV

Technical characteristics

Formation n° x mm ²	Approx. conductor ∅ mm	Average insulation thickness mm	Approx. external ∅ mm	Approx. cable weight kg/km	Current rating A	
					in air	buried*
3 x 10	4,0	3,4	33,2	1670	73	78
3 x 16	4,8	3,4	35,1	1975	107	112
3 x 25	6,0	3,4	37,8	2435	145	149
3 x 35	7,0	3,4	40,3	2865	175	178
3 x 50	8,1	3,4	42,6	3395	208	210
3 x 70	9,7	3,4	46,9	4350	260	257
3 x 95	11,4	3,4	50,7	5375	316	307
3 x 120	12,9	3,4	55,1	6470	365	350
3 x 150	14,3	3,4	58,4	7585	407	390
3 x 185	16,0	3,4	62,3	8990	469	440
3 x 240	18,3	3,4	69,3	11365	550	510
3 x 300	21,0	3,4	75,1	13725	630	580
3 x 400	23,2	3,4	80,8	14275	720	655

(*) Permissible current rating values are according to:

- ground thermal resistivity: 1,0 K-m/W
- ambient temperature 20°C
- laying depth of 0,8 m for buried cables

Electrical characteristics

Formation n° x mm ²	Max. electrical resistance at 20°C Ω/km	Conductor apparent resistance at 90°C and 50Hz Ω/km	Phase reactance Ω/km	Capacity at 50Hz μF/km
3 x 10	1,83	2,34	0,14	0,16
3 x 16	1,15	1,47	0,13	0,18
3 x 25	0,727	0,927	0,12	0,21
3 x 35	0,524	0,669	0,11	0,23
3 x 50	0,387	0,494	0,11	0,26
3 x 70	0,268	0,342	0,10	0,29
3 x 95	0,193	0,247	0,097	0,32
3 x 120	0,153	0,197	0,094	0,36
3 x 150	0,124	0,159	0,091	0,38
3 x 185	0,0991	0,129	0,088	0,42
3 x 240	0,0754	0,0990	0,085	0,47
3 x 300	0,0601	0,0807	0,084	0,52
3 x 400	0,0470	0,0651	0,082	0,57

TRATOS General Cables®

RG16H1OR12 - 8,7/15 kV
 U₀/U: 8,7/15 kV
 U max: 17,5 kV

Technical characteristics

Formation	Approx. conductor Ø	Average insulation thickness	Approx. external Ø	Approx. cable weight	Current rating A	
					in air	buried*
n° x mm ²	mm	mm	mm	kg/km		
3 x 16	4,8	4,5	40,3	2455	98	101
3 x 25	6,0	4,5	42,8	2935	145	145
3 x 35	7,0	4,5	45,2	3375	177	173
3 x 50	8,1	4,5	47,8	3965	210	204
3 x 70	9,7	4,5	51,8	4950	262	250
3 x 95	11,4	4,5	55,9	6040	315	298
3 x 120	12,9	4,5	59,8	7450	361	339
3 x 150	14,3	4,5	63,1	8305	407	378
3 x 185	16,0	4,5	67,4	9790	470	429
3 x 240	18,3	4,5	73,4	12135	550	500
3 x 300	21,0	4,5	80,2	15025	630	565

(*) Permissible current rating values are according to:
 - ground thermal resistivity: 1,0 K-m/W
 - ambient temperature 20°C
 - laying depth of 0,8 m for buried cables

Electrical characteristics

Formation	Max. electrical resistance at 20°C	Conductor apparent resistance at 90°C and 50Hz	Phase reactance	Capacity at 50Hz
n° x mm ²	Ω/km	Ω/km	Ω/km	μF/km
3 x 16	1,15	1,47	0,14	0,15
3 x 25	0,727	0,927	0,13	0,18
3 x 35	0,524	0,669	0,12	0,19
3 x 50	0,387	0,494	0,12	0,21
3 x 70	0,268	0,342	0,11	0,24
3 x 95	0,193	0,247	0,10	0,26
3 x 120	0,153	0,197	0,10	0,29
3 x 150	0,124	0,159	0,097	0,31
3 x 185	0,0991	0,129	0,094	0,34
3 x 240	0,0754	0,0990	0,090	0,37
3 x 300	0,0601	0,0807	0,088	0,42

RG16H1OR12 - 12/20 kV
 U_o/U: 12/20 kV
 U max: 24 kV

Technical characteristics

Formation n° x mm ²	Approx. conductor ∅ mm	Average insulation thickness mm	Approx. external ∅ mm	Approx. cable weight kg/km	Current rating A	
					in air	buried*
3 x 16	4,8	3,4	39,5	2805	105	111
3 x 25	6,0	3,4	41,4	3055	143	145
3 x 35	7,0	3,4	44,9	3805	170	172
3 x 50	8,1	3,4	47,4	4415	205	203
3 x 70	9,7	3,4	51,5	5415	253	250
3 x 95	11,4	3,4	55,5	6545	305	296
3 x 120	12,9	3,4	60,1	7855	353	375
3 x 150	14,3	3,4	63,8	9000	393	375
3 x 185	16,0	3,4	67,9	10510	447	425
3 x 240	18,3	3,4	74,9	13005	525	490
3 x 300	21,0	3,4	80,5	15460	595	550

(*) Permissible current rating values are according to:

- ground thermal resistivity: 1,0 K-m/W
- ambient temperature 20°C
- laying depth of 0,8 m for buried cables

Electrical characteristics

Formation n° x mm ²	Max. electrical resistance at 20°C Ω/km	Conductor apparent resistance at 90°C and 50Hz Ω/km	Phase reactance Ω/km	Capacity at 50Hz μF/km
3 x 16	1,15	1,47	0,13	0,18
3 x 25	0,727	0,927	0,12	0,21
3 x 35	0,524	0,669	0,11	0,23
3 x 50	0,387	0,494	0,11	0,26
3 x 70	0,268	0,342	0,10	0,29
3 x 95	0,193	0,247	0,097	0,32
3 x 120	0,153	0,197	0,094	0,36
3 x 150	0,124	0,159	0,091	0,38
3 x 185	0,0991	0,129	0,088	0,42
3 x 240	0,0754	0,0990	0,085	0,47
3 x 300	0,0601	0,0807	0,084	0,52

TRATOS General Cables®

RG16H1OR12 - 18/30 kV
 U₀/U: 18/30 kV
 U max: 36 kV

Technical characteristics

Formation	Approx. conductor Ø	Average insulation thickness	Approx. external Ø	Approx. cable weight	Current rating A		
					n° x mm ²	mm	mm
3 x 25	7,0	8,0	62,0	5815		177	174
3 x 50	8,1	8,0	64,1	6165		210	205
3 x 70	9,7	8,0	67,9	7265		260	250
3 x 95	11,4	8,0	71,9	8520		315	300
3 x 120	12,9	8,0	77,0	9975		360	340
3 x 150	14,3	8,0	80,4	11285		405	380
3 x 185	16,0	8,0	84,1	12625		465	430
3 x 240	18,3	8,0	90,3	15260		545	496

(*) Permissible current rating values are according to:
 - ground thermal resistivity: 1,0 K·m/W
 - ambient temperature 20°C
 - laying depth of 0,8 m for buried cables

Electrical characteristics

Formation	Max. electrical resistance at 20°C	Conductor apparent resistance at 90°C and 50Hz	Phase reactance	Capacity at 50Hz
n° x mm ²	Ω/km	Ω/km	Ω/km	μF/km
3 x 25	0,524	0,669	0,14	0,14
3 x 50	0,387	0,494	0,13	0,15
3 x 70	0,268	0,342	0,13	0,16
3 x 95	0,193	0,247	0,12	0,18
3 x 120	0,153	0,197	0,12	0,19
3 x 150	0,124	0,159	0,11	0,20
3 x 185	0,0991	0,129	0,11	0,22
3 x 240	0,0754	0,0990	0,10	0,24

RG16H1OR12 - 26/45 kV
 U₀/U: 26/45 kV
 U max: 52 kV

Technical characteristics

Formation n° x mm ²	Approx. conductor ∅ mm	Average insulation thickness mm	Approx. external ∅ mm	Approx. cable weight kg/km	Current rating A	
					in air	buried*
3 x 70	9,7	10,3	81,7	8650	255	241
3 x 95	11,4	10,3	85,6	9980	308	288
3 x 120	12,9	10,0	87,8	12395	353	327
3 x 150	14,3	9,5	89,4	13405	398	366

(*) Permissible current rating values are according to:
 - ground thermal resistivity: 1,0 K-m/W
 - ambient temperature 20°C
 - laying depth of 0,8 m for buried cables

Electrical characteristics

Formation n° x mm ²	Max. electrical resistance at 20°C Ω/km	Conductor apparent resistance at 90°C and 50Hz Ω/km	Phase reactance Ω/km	Capacity at 50Hz μF/km
3 x 70	0,268	0,342	0,14	0,15
3 x 95	0,193	0,247	0,13	0,16
3 x 120	0,153	0,196	0,13	0,17
3 x 150	0,124	0,160	0,12	0,21

RG7H1R | RRG7H1OR cable

TRATOS RG7H1R-1,8/3 ÷ 26/45 kV TRATOS RG7H1OR-1,8/3 ÷ 18/30 kV

Suitable for energy transmission between transformer rooms and big power users. For laying on air, into tube or open pass. Can be laid underground, also if not protected, complying with art. 4.3.11 of CEI 11-17 standard.

FEATURES AND PERFORMANCES

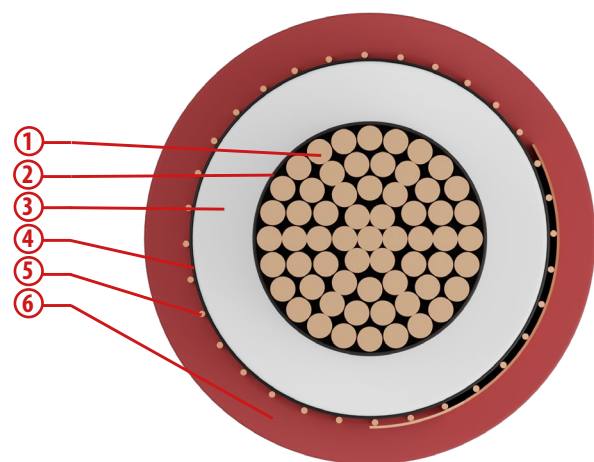

CONSTRUCTION

RG7H1R

Single-core cables, insulated with HEPR rubber of G7 quality, under PVC sheath.

1. CLASS 2, COMPACT STRANDED WIRE, PLAIN COPPER
2. SEMICONDUCTOR LAYER: EXTRUDED (ONLY CABLES UO/U \geq 6/10 KV)
3. HEPR RUBBER, G7 QUALITY, PB FREE
4. SEMICONDUCTOR LAYER: EXTRUDED, COLD STRIPPING (ONLY CABLES UO/U \geq 6/10 KV)
5. PLAIN COPPER WIRES WITH HELICALLY WOUND TAPE
6. PVC BASED COMPOUND, RZ QUALITY

N.B. The cable can be built in the three-pole version with helicallly wound cores. In this case, the initials becomes RG7H1RX, followed by rated voltage.

RG7H1OR

Three-pole cables insulated with HEPR rubber of G7 quality, under PVC sheath.

1. CLASS 2, COMPACT STRANDED WIRE, PLAIN COPPER
2. SEMICONDUCTOR LAYER: EXTRUDED (ONLY CABLES UO/U \geq 6/10 KV)
3. HEPR RUBBER, G7 QUALITY, PB FREE
4. SEMICONDUCTOR LAYER: EXTRUDED, COLD STRIPPING (ONLY CABLES UO/U \geq 6/10 KV)
5. PLAIN COPPER TAPES WRAPPED
6. IDENTIFICATION OF PHASES: THREADS OR COLORED BANDS
7. FILLER: EXTRUDED, PENETRATING BETWEEN THE CORES
8. PVC BASED COMPOUND, RZ QUALITY

The conductor can be made in aluminum and then the initials will be ARG7H1OR followed by rated voltage.

Structure and electrical, physical, mechanical requirements: CEI 20-13 IEC 60502

- Flame propagation EN 60332-1-2
- Measurement of partial discharges CEI 20-16 IEC 60885-3

Cable Marking

Pb free Tratos RG7H1R [rated voltage] [form.] [year] [traceability] [metric]

Pb free Tratos RG7H1OR [rated voltage] [form.] [year] [traceability] [metric]

Installation conditions	
Minimum installation temperature	0°C
Recommended min. bending radius	12 times the cable diameter
Recommended maximum tensile stress	60 N/mm ² of the cross-section of the copper

Functional characteristics	
Rated voltage U ₀ /U	RG7H1R: 1,8/3 ÷ 26/45 kV RG7H1OR: 1,8/3 ÷ 18/30 kV
Max. operating temperature	90°C
Min. operating temperature	-15°C (without mechanical shocks)
Max. short circuit temperature	250°C

RG7H1R - 1,8/3 kV
 U₀/U: 1,8/3 kV
 U max: 3,6 kV

Technical characteristics

Formation n° x mm ²	Approx. conductor Ø mm	Average insulation thickness mm	Max. external Ø mm	Approx. cable weight kg/km	Current rating A			
					in air		buried*	
					trefoil	flat	trefoil	flat
1 x 10	4,0	2,0	14,0	290	87	111	99	104
1 x 16	4,8	2,0	15,0	350	114	145	126	133
1 x 25	6,0	2,0	16,0	450	149	190	162	171
1 x 35	7,0	2,0	17,0	550	181	230	193	204
1 x 50	8,1	2,0	18,5	670	219	276	227	241
1 x 70	9,7	2,0	20,5	880	275	345	278	294
1 x 95	11,4	2,0	22,0	1100	339	422	332	351
1 x 120	12,9	2,0	24,5	1400	393	487	377	399
1 x 150	14,3	2,0	26,0	1650	446	550	421	445
1 x 185	16,0	2,0	27,5	2000	516	635	477	500
1 x 240	18,3	2,0	30,0	2550	617	745	550	580
1 x 300	21,0	2,0	32,5	3150	709	855	621	650
1 x 400	23,2	2,0	35,5	3950	824	990	702	735
1 x 500	26,1	2,2	40,0	5050	954	1140	790	830
1 x 630	30,3	2,4	44,0	6300	1102	1300	885	930

* Ground thermal resistivity 100°C cm/W

Electrical characteristics

Formation n° x mm ²	Max. electrical resistance at 20°C Ω/km	Conductor apparent resistance at 90°C and 50Hz Ω/km		Phase reactance Ω/km		Capacity at 50Hz µF/km
		trefoil	flat	trefoil	flat	
1 x 10	1,83	2,34	2,34	0,13	0,19	0,19
1 x 16	1,15	1,47	1,47	0,12	0,18	0,23
1 x 25	0,727	0,927	0,927	0,12	0,18	0,27
1 x 35	0,524	0,669	0,668	0,11	0,17	0,30
1 x 50	0,387	0,494	0,494	0,11	0,16	0,34
1 x 70	0,268	0,342	0,342	0,10	0,16	0,40
1 x 95	0,193	0,246	0,246	0,098	0,16	0,45
1 x 120	0,153	0,196	0,196	0,095	0,15	0,50
1 x 150	0,124	0,159	0,158	0,092	0,15	0,55
1 x 185	0,0991	0,128	0,127	0,089	0,15	0,60
1 x 240	0,0754	0,0985	0,0974	0,086	0,14	0,68
1 x 300	0,0601	0,0797	0,0781	0,084	0,14	0,75
1 x 400	0,0470	0,0638	0,0628	0,083	0,14	0,83
1 x 500	0,0366	0,0517	0,0492	0,081	0,14	0,88
1 x 630	0,0283	0,0425	0,0392	0,079	0,14	0,92

TRATOS General Cables®

RG7H1R - 3,6/6 kV
 U₀/U: 3,6/6 kV
 U max: 7,2 kV

Technical characteristics

Formation n° x mm ²	Approx. conductor Ø mm	Average insulation thickness mm	Max. external Ø mm	Approx. cable weight kg/km	Current rating A			
					in air		buried*	
					trefoil	flat	trefoil	flat
1 x 10	4,0	3,0	16,0	330	87	105	95	100
1 x 16	4,8	3,0	17,0	410	113	136	122	128
1 x 25	6,0	3,0	18,5	510	150	180	156	165
1 x 35	7,0	3,0	20,0	630	182	220	187	197
1 x 50	8,1	3,0	21,5	750	219	261	220	233
1 x 70	9,7	3,0	23,5	1010	275	328	271	286
1 x 95	11,4	3,0	25,0	1250	337	402	324	342
1 x 120	12,9	3,0	26,5	1500	390	465	370	390
1 x 150	14,3	3,0	28,0	1800	443	525	412	435
1 x 185	16,0	3,0	30,0	2100	512	605	468	491
1 x 240	18,3	3,0	32,5	2650	608	715	540	570
1 x 300	21,0	3,0	35,3	3200	700	820	610	640
1 x 400	23,2	3,0	37,5	4000	813	950	690	725
1 x 500	26,1	3,2	41,6	5100	940	1100	780	820
1 x 630	30,3	3,2	46,0	6500	1082	1260	875	915

* Ground thermal resistivity 100°C cm/W

Electrical characteristics

Formation n° x mm ²	Max. electrical resistance at 20°C Ω/km	Conductor apparent resistance at 90°C and 50Hz Ω/km		Phase reactance Ω/km		Capacity at 50Hz μF/km
		trefoil	flat	trefoil	flat	
1 x 10	1,83	2,34	2,34	0,14	0,20	0,15
1 x 16	1,15	1,47	1,47	0,14	0,19	0,17
1 x 25	0,727	0,927	0,927	0,13	0,18	0,20
1 x 35	0,524	0,669	0,668	0,12	0,18	0,23
1 x 50	0,387	0,494	0,494	0,11	0,17	0,25
1 x 70	0,268	0,342	0,342	0,11	0,17	0,29
1 x 95	0,193	0,246	0,246	0,10	0,16	0,33
1 x 120	0,153	0,196	0,196	0,10	0,16	0,37
1 x 150	0,124	0,159	0,158	0,097	0,16	0,40
1 x 185	0,0991	0,128	0,127	0,094	0,15	0,44
1 x 240	0,0754	0,0985	0,0974	0,091	0,15	0,49
1 x 300	0,0601	0,0797	0,0781	0,089	0,15	0,54
1 x 400	0,0470	0,0638	0,0628	0,087	0,15	0,60
1 x 500	0,0366	0,0517	0,0492	0,084	0,14	0,64
1 x 630	0,0283	0,0425	0,0392	0,082	0,14	0,72

RG7H1R - 6/10 kV
 U₀/U: 6/10 kV
 U max: 12 kV

Technical characteristics

Formation n° x mm ²	Approx. conductor Ø mm	Average insulation thickness mm	Approx. external Ø mm	Approx. cable weight kg/km	Current rating A			
					in air		buried*	
					trefoil	flat	trefoil	flat
1 x 10	4,0	3,4	19,5	420	91	105	93	98
1 x 16	4,8	3,4	21,0	530	117	136	120	128
1 x 25	6,0	3,4	22,2	650	154	178	155	163
1 x 35	7,0	3,4	23,0	760	186	219	185	195
1 x 50	8,1	3,4	24,5	880	223	260	218	231
1 x 70	9,7	3,4	26,5	1100	279	325	270	285
1 x 95	11,4	3,4	28,0	1400	340	398	320	340
1 x 120	12,9	3,4	29,3	1630	395	460	365	385
1 x 150	14,3	3,4	31,0	1900	448	520	410	432
1 x 185	16,0	3,4	33,3	2350	516	600	464	490
1 x 240	18,3	3,4	35,6	2900	610	705	540	565
1 x 300	21,0	3,4	38,5	3500	703	810	605	635
1 x 400	23,2	3,4	41,0	4300	815	935	690	720
1 x 500	26,1	3,4	45,0	5420	945	1080	780	810
1 x 630	30,3	3,4	48,0	6850	1085	1230	875	900

* Ground thermal resistivity 100°C cm/W

Electrical characteristics

Formation n° x mm ²	Max. electrical resistance at 20°C Ω/km	Conductor apparent resistance at 90°C and 50Hz Ω/km		Phase reactance Ω/km		Capacity at 50Hz µF/km
		trefoil	flat	trefoil	flat	
1 x 10	1,83	2,34	2,34	0,16	0,21	0,16
1 x 16	1,15	1,47	1,47	0,15	0,20	0,18
1 x 25	0,727	0,927	0,927	0,14	0,19	0,21
1 x 35	0,524	0,669	0,669	0,13	0,19	0,23
1 x 50	0,387	0,494	0,494	0,12	0,18	0,26
1 x 70	0,268	0,342	0,342	0,12	0,17	0,29
1 x 95	0,193	0,246	0,246	0,11	0,17	0,32
1 x 120	0,153	0,196	0,196	0,11	0,16	0,36
1 x 150	0,124	0,159	0,158	0,10	0,16	0,38
1 x 185	0,0991	0,128	0,127	0,10	0,16	0,42
1 x 240	0,0754	0,0985	0,0973	0,097	0,16	0,47
1 x 300	0,0601	0,0797	0,0780	0,095	0,15	0,52
1 x 400	0,0470	0,0638	0,0617	0,092	0,15	0,57
1 x 500	0,0366	0,0517	0,0490	0,089	0,15	0,64
1 x 630	0,0283	0,0425	0,0390	0,087	0,15	0,73

TRATOS General Cables®

RG7H1R - 8,7/15 kV
 U₀/U: 8,7/15 kV
 U max: 17,5 kV

Technical characteristics

Formation n° x mm ²	Approx. conductor Ø mm	Average insulation thickness mm	Max. external Ø mm	Approx. cable weight kg/km	Current rating A			
					in air		buried*	
					trefoil	flat	trefoil	flat
1 x 16	4,8	4,5	23,3	650	120	135	118	123
1 x 25	6,0	4,5	24,5	750	155	177	152	158
1 x 35	7,0	4,5	25,8	850	190	215	181	190
1 x 50	8,1	4,5	27,0	1000	225	258	213	224
1 x 70	9,7	4,5	28,5	1220	282	323	262	276
1 x 95	11,4	4,5	30,1	1500	345	393	313	330
1 x 120	12,9	4,5	32,5	1900	400	455	358	375
1 x 150	14,3	4,5	33,5	2100	450	515	396	420
1 x 185	16,0	4,5	35,5	2500	518	590	453	475
1 x 240	18,3	4,5	38,0	3030	615	700	525	550
1 x 300	21,0	4,5	41,5	3800	704	800	590	620
1 x 400	23,2	4,5	43,3	4600	816	920	670	700
1 x 500	26,1	4,5	47,4	5700	945	1060	760	785
1 x 630	30,3	4,5	52,6	7100	1088	1210	850	870

* Ground thermal resistivity 100°C cm/W

Electrical characteristics

Formation n° x mm ²	Max. electrical resistance at 20°C Ω/km	Conductor apparent resistance at 90°C and 50Hz Ω/km		Phase reactance Ω/km		Capacity at 50Hz µF/km
		trefoil	flat	trefoil	flat	
1 x 16	1,15	1,47	1,47	0,15	0,21	0,15
1 x 25	0,727	0,927	0,927	0,14	0,20	0,18
1 x 35	0,524	0,669	0,669	0,14	0,19	0,19
1 x 50	0,387	0,494	0,494	0,13	0,19	0,21
1 x 70	0,268	0,342	0,342	0,12	0,18	0,24
1 x 95	0,193	0,246	0,246	0,12	0,17	0,26
1 x 120	0,153	0,196	0,196	0,11	0,17	0,29
1 x 150	0,124	0,159	0,158	0,11	0,17	0,31
1 x 185	0,0991	0,128	0,127	0,11	0,16	0,34
1 x 240	0,0754	0,0985	0,0973	0,10	0,16	0,37
1 x 300	0,0601	0,0797	0,0780	0,099	0,16	0,42
1 x 400	0,0470	0,0638	0,0617	0,096	0,15	0,45
1 x 500	0,0366	0,0517	0,0490	0,092	0,15	0,51
1 x 630	0,0283	0,0425	0,0390	0,090	0,15	0,58

RG7H1R - 12/20 kV
 U₀/U: 12/20 kV
 U max: 24 kV

Technical characteristics

Formation n° x mm ²	Approx. conductor Ø mm	Average insulation thickness mm	Max. external Ø mm	Approx. cable weight kg/km	Current rating A			
					in air		buried*	
					trefoil	flat	trefoil	flat
1 x 25	6,0	5,5	25,0	814	158	176	153	158
1 x 35	7,0	5,5	27,7	960	190	213	182	189
1 x 50	8,1	5,5	29,0	1100	230	255	216	225
1 x 70	9,7	5,5	30,5	1350	285	320	265	275
1 x 95	11,4	5,5	33,0	1650	348	390	315	329
1 x 120	12,9	5,5	34,8	1950	400	450	360	374
1 x 150	14,3	5,5	36,2	2300	450	510	402	416
1 x 185	16,0	5,5	37,6	2600	520	585	455	472
1 x 240	18,3	5,5	40,2	3200	615	690	528	545
1 x 300	21,0	5,5	43,0	3900	705	790	595	611
1 x 400	23,2	5,5	45,8	4800	815	910	674	690
1 x 500	26,1	5,5	50,0	5900	945	1050	762	776
1 x 630	30,3	5,5	54,0	7300	1087	1190	858	875

* Ground thermal resistivity 100°C cm/W

Electrical characteristics

Formation n° x mm ²	Max. electrical resistance at 20°C Ω/km	Conductor apparent resistance at 90°C and 50Hz Ω/km		Phase reactance Ω/km		Capacity at 50Hz µF/km
		trefoil	flat	trefoil	flat	
1 x 25	0,727	0,927	0,927	0,14	0,20	0,16
1 x 35	0,524	0,669	0,669	0,14	0,20	0,17
1 x 50	0,387	0,494	0,494	0,13	0,19	0,18
1 x 70	0,268	0,342	0,342	0,13	0,19	0,21
1 x 95	0,193	0,246	0,246	0,12	0,18	0,23
1 x 120	0,153	0,196	0,196	0,12	0,18	0,25
1 x 150	0,124	0,159	0,158	0,11	0,17	0,27
1 x 185	0,0991	0,128	0,127	0,11	0,17	0,29
1 x 240	0,0754	0,0985	0,0972	0,11	0,16	0,32
1 x 300	0,0601	0,0797	0,0779	0,10	0,16	0,35
1 x 400	0,0470	0,0638	0,0616	0,099	0,16	0,39
1 x 500	0,0366	0,0517	0,0489	0,096	0,15	0,43
1 x 630	0,0283	0,0425	0,0389	0,093	0,15	0,49

TRATOS General Cables®

RG7H1R - 18/30 kV
 U₀/U: 18/30 kV
 U max: 36 kV

Technical characteristics

Formation n° x mm ²	Approx. conductor Ø mm	Average insulation thickness mm	Max. external Ø mm	Approx. cable weight kg/km	Current rating A			
					in air		buried*	
					trefoil	flat	trefoil	flat
1 x 50	8,1	8,0	34,1	1400	229	254	214	222
1 x 70	9,7	8,0	36,2	1700	285	316	263	272
1 x 95	11,4	8,0	38,2	1950	347	387	314	325
1 x 120	12,9	8,0	40,0	2230	401	445	358	370
1 x 150	14,3	8,0	41,0	2550	452	505	400	415
1 x 185	16,0	8,0	43,1	3000	520	580	453	469
1 x 240	18,3	8,0	45,0	3600	615	680	525	540
1 x 300	21,0	8,0	47,0	4300	705	775	593	606
1 x 400	23,2	8,0	51,1	5200	815	895	671	685
1 x 500	26,1	8,0	53,0	6300	943	1030	761	775
1 x 630	30,3	8,0	60,2	7800	1085	1170	860	875

* Ground thermal resistivity 100°C cm/W

Electrical characteristics

Formation n° x mm ²	Max. electrical resistance at 20°C Ω/km	Conductor apparent resistance at 90°C and 50Hz Ω/km		Phase reactance Ω/km		Capacity at 50Hz µF/km
		trefoil	flat	trefoil	flat	
1 x 50	0,387	0,494	0,494	0,15	0,20	0,15
1 x 70	0,268	0,342	0,342	0,14	0,20	0,16
1 x 95	0,193	0,246	0,246	0,13	0,19	0,18
1 x 120	0,153	0,196	0,196	0,13	0,18	0,19
1 x 150	0,124	0,159	0,158	0,12	0,18	0,20
1 x 185	0,0991	0,128	0,127	0,12	0,18	0,22
1 x 240	0,0754	0,0985	0,0972	0,11	0,17	0,24
1 x 300	0,0601	0,0797	0,0779	0,11	0,17	0,27
1 x 400	0,0470	0,0638	0,0616	0,11	0,16	0,29
1 x 500	0,0366	0,0517	0,0489	0,10	0,16	0,32
1 x 630	0,0283	0,0425	0,0389	0,099	0,16	0,36

RG7H1R - 26/45 kV
 U₀/U: 26/45 kV
 U max: 52 kV

Technical characteristics

Formation n° x mm ²	Approx. conductor Ø mm	Average insulation thickness mm	Max. external Ø mm	Approx. cable weight kg/km	Current rating A			
					in air		buried*	
					trefoil	flat	trefoil	flat
1 x 50	8,1	10,3	39,9	1945	225	250	205	212
1 x 70	9,7	10,3	41,9	2150	280	315	255	260
1 x 95	11,4	10,3	43,8	2490	340	380	300	310
1 x 120	12,9	10,0	44,8	2735	395	440	355	365
1 x 150	14,3	9,5	45,1	3020	445	495	385	395
1 x 185	16,0	9,3	47,1	3395	510	570	440	450
1 x 240	18,3	9,3	49,2	4025	600	665	510	520
1 x 300	21,0	9,0	52,2	4725	695	760	570	580
1 x 400	23,2	9,0	54,8	5635	800	875	650	655
1 x 500	26,1	9,0	58,6	6825	930	1010	735	740
1 x 630	30,3	9,0	62,7	8260	1070	1180	835	845

* Ground thermal resistivity 100°C cm/W

Electrical characteristics

Formation n° x mm ²	Max. electrical resistance at 20°C Ω/km	Conductor apparent resistance at 90°C and 50Hz Ω/km		Phase reactance Ω/km		Capacity at 50Hz μF/km
		trefoil	flat	trefoil	flat	
1 x 50	0,387	0,494	0,494	0,15	0,20	0,15
1 x 70	0,268	0,342	0,342	0,15	0,21	0,15
1 x 95	0,193	0,246	0,246	0,14	0,20	0,16
1 x 120	0,153	0,196	0,196	0,14	0,20	0,18
1 x 150	0,124	0,159	0,158	0,13	0,19	0,20
1 x 185	0,0991	0,128	0,127	0,13	0,19	0,21
1 x 240	0,0754	0,0985	0,0972	0,12	0,18	0,23
1 x 300	0,0601	0,0797	0,0779	0,12	0,18	0,26
1 x 400	0,0470	0,0638	0,0616	0,11	0,17	0,28
1 x 500	0,0366	0,0517	0,0489	0,11	0,17	0,31
1 x 630	0,0283	0,0425	0,0389	0,10	0,16	0,34

TRATOS General Cables®

RG7H1OR - 1,8/3 kV
 U₀/U: 1,8/3 kV
 U max: 3,6 kV

Technical characteristics

Formation n° x mm ²	Approx. conductor Ø mm	Average insulation thickness mm	Max. external Ø mm	Approx. cable weight kg/km	Current rating A	
					in air	buried*
3 x 10	4,0	2,0	26,0	1050	85	93
3 x 16	4,8	2,0	28,0	1200	109	120
3 x 25	6,0	2,0	30,2	1600	145	155
3 x 35	7,0	2,0	34,0	2000	175	185
3 x 50	8,1	2,0	36,0	2250	208	216
3 x 70	9,7	2,0	40,0	3200	260	265
3 x 95	11,4	2,0	43,4	4100	318	315
3 x 120	12,9	2,0	48,0	5000	367	360
3 x 150	14,3	2,0	52,0	5960	415	400
3 x 185	16,0	2,0	55,0	7100	476	453
3 x 240	18,3	2,0	62,0	9300	555	520
3 x 300	21,0	2,0	68,0	13000	635	585
3 x 400	23,2	2,0	75,0	14000	716	651

* Ground thermal resistivity 100°C cm/W

Electrical characteristics

Formation n° x mm ²	Max. electrical resistance at 20°C Ω/km	Conductor apparent resistance at 90°C and 50Hz Ω/km	Phase reactance Ω/km	Capacity at 50Hz µF/km
3 x 10	1,83	2,34	0,11	0,19
3 x 16	1,15	1,47	0,10	0,23
3 x 25	0,727	0,927	0,097	0,27
3 x 35	0,524	0,669	0,093	0,30
3 x 50	0,387	0,494	0,088	0,34
3 x 70	0,268	0,342	0,084	0,40
3 x 95	0,193	0,247	0,081	0,45
3 x 120	0,153	0,197	0,079	0,50
3 x 150	0,124	0,159	0,077	0,55
3 x 185	0,0991	0,129	0,076	0,60
3 x 240	0,0754	0,0990	0,074	0,68
3 x 300	0,0601	0,0807	0,072	0,75
3 x 400	0,0470	0,0651	0,071	0,83

RG7H1OR - 3,6/6 kV
 U_o/U: 3,6/6 kV
 U max: 7,2 kV

Technical characteristics

Formation n° x mm ²	Approx. conductor ∅ mm	Average insulation thickness mm	Max. external ∅ mm	Approx. cable weight kg/km	Current rating A	
					in air	buried*
3 x 10	4,0	3,0	30,5	1220	85	93
3 x 16	4,8	3,0	32,5	1500	109	120
3 x 25	6,0	3,0	35,5	1850	145	153
3 x 35	7,0	3,0	37,5	2300	175	183
3 x 50	8,1	3,0	40,5	2800	211	216
3 x 70	9,7	3,0	44,5	3560	262	263
3 x 95	11,4	3,0	48,5	4510	318	315
3 x 120	12,9	3,0	52,0	5500	370	359
3 x 150	14,3	3,0	55,0	6350	415	400
3 x 185	16,0	3,0	59,5	7700	477	451
3 x 240	18,3	3,0	65,5	9700	555	518
3 x 300	21,0	3,0	70,5	11800	635	583
3 x 400	23,2	3,0	77,0	15000	717	651

* Ground thermal resistivity 100°C cm/W

Electrical characteristics

Formation n° x mm ²	Max. electrical resistance at 20°C Ω/km	Conductor apparent resistance at 90°C and 50Hz Ω/km	Phase reactance Ω/km	Capacity at 50Hz μF/km
3 x 10	1,83	2,34	0,12	0,15
3 x 16	1,15	1,47	0,12	0,17
3 x 25	0,727	0,927	0,11	0,20
3 x 35	0,524	0,669	0,10	0,23
3 x 50	0,387	0,494	0,097	0,26
3 x 70	0,268	0,342	0,092	0,30
3 x 95	0,193	0,247	0,089	0,33
3 x 120	0,153	0,197	0,086	0,37
3 x 150	0,124	0,159	0,084	0,40
3 x 185	0,0991	0,129	0,082	0,44
3 x 240	0,0754	0,0990	0,079	0,49
3 x 300	0,0601	0,0807	0,077	0,54
3 x 400	0,0470	0,0651	0,075	0,60

TRATOS General Cables®

RG7H1OR - 6/10 kV
 U₀/U: 6/10 kV
 U max: 12 kV

Technical characteristics

Formation	Approx. conductor Ø	Average insulation thickness	Max. external Ø	Approx. cable weight	Current rating A	
					n° x mm ²	mm
3 x 10	4,0	3,4	37,0	1650	73	78
3 x 16	4,8	3,4	40,0	2100	107	112
3 x 25	6,0	3,4	42,5	2550	145	149
3 x 35	7,0	3,4	45,0	2850	175	178
3 x 50	8,1	3,4	48,0	3600	208	210
3 x 70	9,7	3,4	52,0	4200	260	257
3 x 95	11,4	3,4	56,0	5400	316	307
3 x 120	12,9	3,4	60,0	6300	365	350
3 x 150	14,3	3,4	63,0	7400	407	390
3 x 185	16,0	3,4	68,0	8600	469	440
3 x 240	18,3	3,4	74,0	11000	550	510
3 x 300	21,0	3,4	79,0	13000	630	580
3 x 400	23,2	3,4	85,0	16000	720	655

* Ground thermal resistivity 100°C cm/W

Electrical characteristics

Formation	Max. electrical resistance at 20°C	Conductor apparent resistance at 90°C and 50Hz	Phase reactance	Capacity at 50Hz
n° x mm ²	Ω/km	Ω/km	Ω/km	μF/km
3 x 10	1,83	2,34	0,14	0,16
3 x 16	1,15	1,47	0,13	0,18
3 x 25	0,727	0,927	0,12	0,21
3 x 35	0,524	0,669	0,11	0,23
3 x 50	0,387	0,494	0,11	0,26
3 x 70	0,268	0,342	0,10	0,29
3 x 95	0,193	0,247	0,097	0,32
3 x 120	0,153	0,197	0,094	0,36
3 x 150	0,124	0,159	0,091	0,38
3 x 185	0,0991	0,129	0,088	0,42
3 x 240	0,0754	0,0990	0,085	0,47
3 x 300	0,0601	0,0807	0,084	0,52
3 x 400	0,0470	0,0651	0,082	0,57

RG7H1OR - 8,7/15 kV
 U₀/U: 8,7/15 kV
 U max: 17,5 kV

Technical characteristics

Formation	Approx. conductor Ø	Average insulation thickness	Approx. external Ø	Max. cable weight	Current rating A	
					n° x mm ²	mm
3 x 16	4,8	4,5	46,0	2500	98	101
3 x 25	6,0	4,5	50,0	2900	145	145
3 x 35	7,0	4,5	52,0	3500	177	173
3 x 50	8,1	4,5	54,0	4000	210	204
3 x 70	9,7	4,5	58,0	4800	262	250
3 x 95	11,4	4,5	62,0	5900	315	298
3 x 120	12,9	4,5	66,0	6950	361	339
3 x 150	14,3	4,5	70,0	8000	407	378
3 x 185	16,0	4,5	74,0	9500	470	429
3 x 240	18,3	4,5	78,0	11800	550	500
3 x 300	21,0	4,5	85,0	14200	630	565

* Ground thermal resistivity 100°C cm/W

Electrical characteristics

Formation	Max. electrical resistance at 20°C	Conductor apparent resistance at 90°C and 50Hz	Phase reactance	Capacity at 50Hz
n° x mm ²	Ω/km	Ω/km	Ω/km	μF/km
3 x 16	1,15	1,47	0,14	0,15
3 x 25	0,727	0,927	0,13	0,18
3 x 35	0,524	0,669	0,12	0,19
3 x 50	0,387	0,494	0,12	0,21
3 x 70	0,268	0,342	0,11	0,24
3 x 95	0,193	0,247	0,10	0,26
3 x 120	0,153	0,197	0,10	0,29
3 x 150	0,124	0,159	0,097	0,31
3 x 185	0,0991	0,129	0,094	0,34
3 x 240	0,0754	0,0990	0,090	0,37
3 x 300	0,0601	0,0807	0,088	0,42

TRATOS General Cables®

RG7H1OR - 12/20 kV
 U₀/U: 12/20 kV
 U max: 24 kV

Technical characteristics

Formation	Approx. conductor Ø	Average insulation thickness	Max. external Ø	Approx. cable weight	Current rating A	
					in air	buried*
n° x mm ²	mm	mm	mm	kg/km		
3 x 35	7,0	5,5	56,3	3950	177	175
3 x 50	8,1	5,5	58,0	4500	210	207
3 x 70	9,7	5,5	64,0	5500	262	253
3 x 95	11,4	5,5	67,0	6600	315	301
3 x 120	12,9	5,5	70,5	7600	361	342
3 x 150	14,3	5,5	73,6	8600	407	381
3 x 185	16,0	5,5	78,0	11000	470	431
3 x 240	18,3	5,5	84,0	12500	550	500
3 x 300	21,0	5,5	90,0	15000	630	562

* Ground thermal resistivity 100°C cm/W

Electrical characteristics

Formation	Max. electrical resistance at 20°C	Conductor apparent resistance at 90°C and 50Hz	Phase reactance	Capacity at 50Hz
n° x mm ²	Ω/km	Ω/km	Ω/km	μF/km
3 x 35	0,524	0,669	0,13	0,17
3 x 50	0,387	0,494	0,12	0,18
3 x 70	0,268	0,342	0,11	0,21
3 x 95	0,193	0,247	0,10	0,23
3 x 120	0,153	0,197	0,10	0,25
3 x 150	0,124	0,159	0,10	0,27
3 x 185	0,0991	0,129	0,098	0,29
3 x 240	0,0754	0,0990	0,094	0,32
3 x 300	0,0601	0,0807	0,092	0,35

RG7H1OR - 18/30 kV
 U_o/U: 18/30 kV
 U max: 36 kV

Technical characteristics

Formation n° x mm ²	Approx. conductor ∅ mm	Average insulation thickness mm	Max. external ∅ mm	Approx. cable weight kg/km	Current rating A	
					in air	buried*
3 x 50	8,1	8,0	73,0	5980	210	205
3 x 70	9,7	8,0	76,0	6800	260	250
3 x 95	11,4	8,0	81,0	8400	315	300
3 x 120	12,9	8,0	84,0	9400	360	340
3 x 150	14,3	8,0	86,0	11000	405	380
3 x 185	16,0	8,0	90,0	13000	465	430
3 x 240	18,3	8,0	96,0	15000	545	496

* Ground thermal resistivity 100°C cm/W

Electrical characteristics

Formation n° x mm ²	Max. electrical resistance at 20°C Ω/km	Conductor apparent resistance at 90°C and 50Hz Ω/km	Phase reactance Ω/km	Capacity at 50Hz μF/km
3 x 50	0,387	0,494	0,13	0,15
3 x 70	0,268	0,342	0,13	0,16
3 x 95	0,193	0,247	0,12	0,18
3 x 120	0,153	0,197	0,12	0,19
3 x 150	0,124	0,159	0,11	0,20
3 x 185	0,0991	0,129	0,11	0,22
3 x 240	0,0754	0,0990	0,10	0,24

ARG7H1R | ARG7H1OR cable

TRATOS ARG7H1R -1,8/3 kV, 6/10 kV, 12/20 kV, 18/30 kV TRATOS ARG7H1OR -3,6/6 kV, 6/10 kV, 12/20 kV, 18/30 kV

Suitable for energy transmission between transformer rooms and big power users. For laying on air, into tube or open pass. Can be laid underground, also if not protected, complying with art. 4.3.11 of CEI 11-17 standard.

FEATURES AND PERFORMANCES

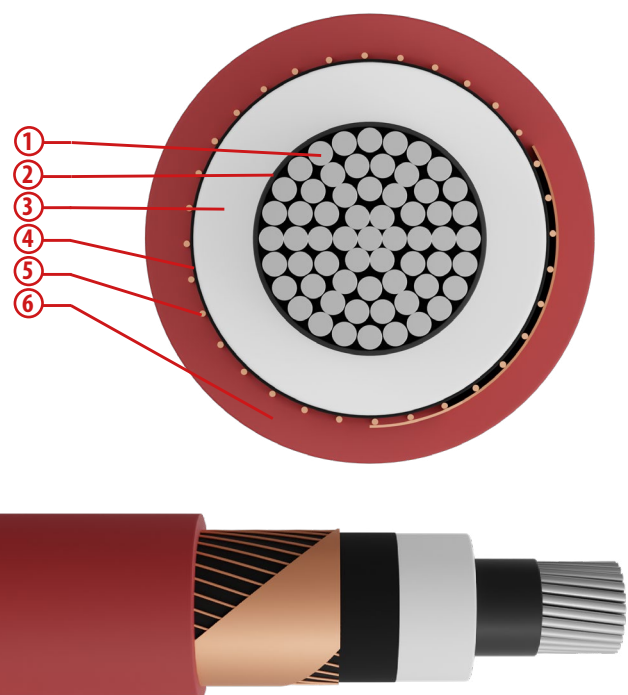

CONSTRUCTION

ARG7H1R

Single-core cables, insulated with HEPR rubber of G7 quality, under PVC sheath.

1. CLASS 2, COMPACT STRANDED WIRE, ALUMINUM
2. SEMICONDUCTOR LAYER: EXTRUDED (ONLY CABLES UO/U \geq 6/10 KV)
3. HEPR RUBBER, G7 QUALITY, PB FREE
4. SEMICONDUCTOR LAYER: EXTRUDED, COLD STRIPPING (ONLY CABLES UO/U \geq 6/10 KV)
5. PLAIN COPPER WIRES WITH HELICALLY WOUND TAPE
6. PVC BASED COMPOUND, RZ QUALITY

N.B. The cable can be built in the three-pole version with helically wound cores. In this case, the initials becomes ARG7H1RX, followed by rated voltage

ARG7H1OR

Three-pole cables insulated with HEPR rubber of G7 quality, under PVC sheath.

1. CLASS 2, COMPACT STRANDED WIRE, PLAIN COPPER
2. SEMICONDUCTOR LAYER: EXTRUDED (ONLY CABLES UO/U \geq 6/10 KV)
3. HEPR RUBBER, G7 QUALITY, PB FREE
4. SEMICONDUCTOR LAYER: EXTRUDED, COLD STRIPPING (ONLY CABLES UO/U \geq 6/10 KV)
5. PLAIN COPPER TAPES WRAPPED
6. IDENTIFICATION OF PHASES: THREADS OR COLORED BANDS
7. FILLER: EXTRUDED, PENETRATING BETWEEN THE CORES
8. PVC BASED COMPOUND, RZ QUALITY

Structure and electrical, physical, mechanical requirements: CEI 20-13 IEC 60502

• Flame propagation	EN 60332-1-2
• Corrosive gases or halogens	EN 50267-2-1
• Measurement of partial discharges	CEI 20-16 IEC 60885-3

Cable Marking

Pb free Tratos ARG7H1R [rated voltage] [form.] [year] [traceability] [metric]

Pb free Tratos ARG7H1OR [rated voltage] [form.] [year] [traceability] [metric]

Installation conditions	
Minimum installation temperature	0°C
Recommended min. bending radius	12 times the cable diameter
Recommended maximum tensile stress	50 N/mm ² of the cross-section of the copper

Functional characteristics	
Rated voltage U ₀ /U	ARG7H1R: 1,8/3 kV, 6/10 kV, 12/20 kV, 18/30 kV ARG7H1OR: 3,6/6 kV, 6/10 kV, 12/20 kV, 18/30 kV
Max. operating temperature	90°C
Min. operating temperature	-15°C (without mechanical shocks)
Max. short circuit temperature	250°C

ARG7H1R - 1,8/3 kV
 U_o/U: 1,8/3 kV
 U max: 3,6 kV

Technical characteristics

Formation n° x mm ²	Approx. conductor Ø mm	Average insulation thickness mm	Max. external Ø mm	Approx. cable weight kg/km	Current rating A			
					in air		buried*	
					trefoil	flat	trefoil	flat
1 x 25	6,0	2,0	16,0	315	119	121	105	109
1 x 35	7,0	2,0	17,0	360	144	147	129	130
1 x 50	8,1	2,0	18,5	410	174	178	149	153
1 x 70	9,7	2,0	20,5	495	218	223	182	188
1 x 95	11,4	2,0	22,0	600	266	273	217	224
1 x 120	12,9	2,0	24,5	700	309	317	247	256
1 x 150	14,3	2,0	26,0	790	352	361	277	287
1 x 185	16,0	2,0	27,5	1225	406	417	314	325
1 x 240	18,3	2,0	30,0	1475	483	495	364	377
1 x 300	21,0	2,0	32,5	1707	556	570	411	426
1 x 400	23,6	2,0	35,5	2260	651	667	471	487
1 x 500	26,5	2,0	40,0	2590	730	746	530	550
1 x 630	30,1	2,0	44,0	3150	810	832	600	622

* Ground thermal resistivity 100°C cm/W

Electrical characteristics

Formation n° x mm ²	Max. electrical resistance at 20°C Ω/km	Conductor apparent resistance at 90°C and 50Hz Ω/km		Phase reactance Ω/km		Capacity at 50Hz µF/km
		trefoil	flat	trefoil	flat	
1 x 25	1,20	0,927	0,927	0,12	0,18	0,27
1 x 35	0,868	0,669	0,668	0,11	0,17	0,30
1 x 50	0,641	0,494	0,494	0,11	0,16	0,34
1 x 70	0,443	0,342	0,342	0,10	0,16	0,40
1 x 95	0,320	0,246	0,246	0,098	0,16	0,45
1 x 120	0,253	0,196	0,196	0,095	0,15	0,50
1 x 150	0,206	0,159	0,158	0,092	0,15	0,55
1 x 185	0,164	0,128	0,127	0,089	0,15	0,60
1 x 240	0,125	0,0985	0,0974	0,086	0,14	0,68
1 x 300	0,100	0,0797	0,0781	0,084	0,14	0,75
1 x 400	0,0778	0,0638	0,0628	0,083	0,14	0,83
1 x 500	0,0605	0,0517	0,0492	0,081	0,14	0,88
1 x 630	0,0469	0,0425	0,0392	0,079	0,14	0,92

TRATOS General Cables®

ARG7H1R - 6/10 kV
 U₀/U: 6/10 kV
 U max: 12 kV

Technical characteristics

Formation n° x mm ²	Approx. conductor Ø mm	Average insulation thickness mm	Approx. external Ø mm	Max. cable weight kg/km	Current rating A			
					in air		buried*	
					trefoil	flat	trefoil	flat
1 x 35	7,0	3,4	23,0	535	144	152	142	149
1 x 50	8,1	3,4	24,5	600	174	183	168	177
1 x 70	9,7	3,4	26,5	700	218	229	207	218
1 x 95	11,4	3,4	28,0	825	266	280	247	260
1 x 120	12,9	3,4	29,3	950	309	325	281	296
1 x 150	14,3	3,4	31,0	1070	352	371	318	335
1 x 185	16,0	3,4	33,3	1225	406	427	361	380
1 x 240	18,3	3,4	35,6	1475	483	508	418	440
1 x 300	21,0	3,4	38,5	1710	547	576	472	497
1 x 400	23,6	3,4	41,0	2260	640	674	543	572
1 x 500	26,5	3,4	45,0	2590	740	779	621	654
1 x 630	30,1	3,4	48,0	3150	862	907	706	743

* Ground thermal resistivity 100°C cm/W

Electrical characteristics

Formation n° x mm ²	Max. electrical resistance at 20°C Ω/km	Conductor apparent resistance at 90°C and 50Hz Ω/km		Phase reactance Ω/km		Capacity at 50Hz µF/km
		trefoil	flat	trefoil	flat	
1 x 35	0,868	0,113	0,113	0,13	0,19	0,23
1 x 50	0,641	0,822	0,822	0,12	0,18	0,26
1 x 70	0,443	0,568	0,568	0,12	0,17	0,29
1 x 95	0,320	0,411	0,411	0,11	0,17	0,32
1 x 120	0,253	0,325	0,325	0,11	0,16	0,36
1 x 150	0,206	0,265	0,265	0,10	0,16	0,38
1 x 185	0,164	0,211	0,211	0,10	0,16	0,42
1 x 240	0,125	0,161	0,161	0,097	0,16	0,47
1 x 300	0,100	0,130	0,129	0,095	0,15	0,52
1 x 400	0,0778	0,102	0,101	0,092	0,15	0,57
1 x 500	0,0605	0,0801	0,0794	0,089	0,15	0,64
1 x 630	0,0469	0,0635	0,0625	0,087	0,15	0,73

ARG7H1R - 12/20 kV

U_o/U: 12/20 kV

U max: 24 kV

Technical characteristics

Formation n° x mm ²	Approx. conductor Ø mm	Average insulation thickness mm	Max. external Ø mm	Approx. cable weight kg/km	Current rating A			
					in air		buried*	
					trefoil	flat	trefoil	flat
1 x 35	7,0	5,5	27,7	750	144	152	142	149
1 x 50	8,1	5,5	29,0	820	174	183	168	177
1 x 70	9,7	5,5	30,5	955	218	229	207	218
1 x 95	11,4	5,5	33,0	1080	266	280	247	260
1 x 120	12,9	5,5	34,8	1255	309	325	281	296
1 x 150	14,3	5,5	36,2	1335	352	371	318	335
1 x 185	16,0	5,5	37,6	1555	406	427	361	380
1 x 240	18,3	5,5	40,2	1840	483	508	418	440
1 x 300	21,0	5,5	43,0	2115	547	576	472	497
1 x 400	23,2	5,5	45,8	2660	640	674	543	572
1 x 500	26,1	5,5	50,0	3185	740	779	621	654
1 x 630	30,3	5,5	54,0	3805	862	907	706	743

* Ground thermal resistivity 100°C cm/W

Electrical characteristics

Formation n° x mm ²	Max. electrical resistance at 20°C Ω/km	Conductor apparent resistance at 90°C and 50Hz Ω/km		Phase reactance Ω/km		Capacity at 50Hz μF/km
		trefoil	flat	trefoil	flat	
1 x 35	0,868	0,113	0,113	0,14	0,20	0,17
1 x 50	0,641	0,822	0,822	0,13	0,19	0,18
1 x 70	0,443	0,568	0,568	0,13	0,19	0,21
1 x 95	0,320	0,411	0,411	0,12	0,18	0,23
1 x 120	0,253	0,325	0,325	0,12	0,18	0,25
1 x 150	0,206	0,265	0,265	0,11	0,17	0,27
1 x 185	0,164	0,211	0,211	0,11	0,17	0,29
1 x 240	0,125	0,161	0,161	0,11	0,16	0,32
1 x 300	0,100	0,130	0,129	0,10	0,16	0,35
1 x 400	0,0778	0,102	0,101	0,099	0,16	0,39
1 x 500	0,0605	0,0801	0,0794	0,096	0,15	0,43
1 x 630	0,0469	0,0635	0,0625	0,093	0,15	0,49

TRATOS General Cables®

ARG7H1R - 18/30 kV
 U₀/U: 18/30 kV
 U max: 36 kV

Technical characteristics

Formation	Approx. conductor Ø	Average insulation thickness	Max. external Ø	Approx. cable weight	Current rating A			
					in air		buried*	
					trefoil	flat	trefoil	flat
n° x mm ²	mm	mm	mm	kg/km				
1 x 35	7,0	8,0	33,5	1045	144	152	142	149
1 x 50	8,1	8,0	34,1	1155	174	183	168	177
1 x 70	9,7	8,0	36,2	1545	218	229	207	218
1 x 95	11,4	8,0	38,2	1290	266	280	247	260
1 x 120	12,9	8,0	40,0	1670	309	325	281	296
1 x 150	14,3	8,0	41,0	1790	352	371	318	335
1 x 185	16,0	8,0	43,1	2005	406	427	361	380
1 x 240	18,3	8,0	45,0	2300	483	508	418	440
1 x 300	21,0	8,0	47,0	2570	547	576	472	497
1 x 400	23,6	8,0	51,1	3145	640	674	543	572
1 x 500	26,5	8,0	53,0	3555	740	779	621	654
1 x 630	30,1	8,0	60,2	4195	862	907	706	743

* Ground thermal resistivity 100°C cm/W

Electrical characteristics

Formation	Max. electrical resistance at 20°C	Conductor apparent resistance at 90°C and 50Hz		Phase reactance		Capacity at 50Hz
		Ω/km		Ω/km		
n° x mm ²	Ω/km	trefoil	flat	trefoil	flat	μF/km
1 x 50	0,387	0,494	0,494	0,15	0,20	0,15
1 x 70	0,268	0,342	0,342	0,14	0,20	0,16
1 x 95	0,193	0,246	0,246	0,13	0,19	0,18
1 x 120	0,153	0,196	0,196	0,13	0,18	0,19
1 x 150	0,124	0,159	0,159	0,12	0,18	0,20
1 x 185	0,0991	0,128	0,127	0,12	0,18	0,22
1 x 240	0,0754	0,0985	0,0972	0,11	0,17	0,24
1 x 300	0,0601	0,0797	0,0972	0,11	0,17	0,27
1 x 400	0,0470	0,0638	0,0616	0,11	0,16	0,29
1 x 500	0,0366	0,0517	0,0489	0,10	0,16	0,32
1 x 630	0,0283	0,0425	0,0389	0,099	0,16	0,36

ARG7H1OR - 3,6/6 kV
 U_o/U: 3,6/6 kV
 U max: 7,2 kV

Technical characteristics

Formation n° x mm ²	Approx. conductor ∅ mm	Average insulation thickness mm	Max. external ∅ mm	Approx. cable weight kg/km	Current rating A	
					in air	buried*
3 x 25	6,10	3,0	31,80	1425	125	125
3 x 35	7,10	3,0	34,06	1635	150	145
3 x 50	8,20	3,0	36,75	1925	164	163
3 x 70	9,90	3,0	40,50	2365	205	204
3 x 95	11,40	3,0	44,45	2885	250	245
3 x 120	13,10	3,0	48,00	3405	288	280
3 x 150	14,40	3,0	51,00	3880	326	312
3 x 185	16,20	3,0	55,15	4535	372	354
3 x 240	18,40	3,0	61,00	5560	438	408
3 x 300	20,65	3,0	65,95	6525	502	460
3 x 400	23,60	3,0	73,25	8505	572	520

* Ground thermal resistivity 100°C cm/W

Electrical characteristics

Formation n° x mm ²	Max. electrical resistance at 20°C Ω/km	Conductor apparent resistance at 90°C and 50Hz Ω/km	Phase reactance Ω/km	Capacity at 50Hz μF/km
3 x 25	1,20	1,270	0,15	0,14
3 x 35	0,868	1,113	0,14	0,15
3 x 50	0,641	0,822	0,13	0,17
3 x 70	0,443	0,568	0,13	0,19
3 x 95	0,320	0,411	0,12	0,21
3 x 120	0,253	0,325	0,12	0,23
3 x 150	0,206	0,265	0,11	0,25
3 x 185	0,164	0,211	0,11	0,27
3 x 240	0,125	0,161	0,10	0,30
3 x 300	0,100	0,130	0,096	0,34
3 x 400	0,0778	0,102	0,093	0,38

TRATOS General Cables®

ARG7H1OR - 6/10 kV

U₀/U: 6/10 kV

U max: 12 kV

Technical characteristics

Formation	Approx. conductor Ø	Average insulation thickness	Max. external Ø	Approx. cable weight	Current rating A		
					n° x mm ²	mm	mm
3 x 25	6,10	3,4	38,10	1985		113	116
3 x 35	7,0	3,4	40,50	2250		137	139
3 x 50	8,1	3,4	42,90	2545		162	164
3 x 70	9,7	3,4	47,10	3105		203	200
3 x 95	11,4	3,4	50,80	3670		246	239
3 x 120	12,9	3,4	54,60	4275		285	273
3 x 150	14,3	3,4	57,60	4785		317	304
3 x 185	16,0	3,4	61,90	5537		366	343
3 x 240	18,3	3,4	68,20	6765		429	398
3 x 300	21,0	3,4	73,20	7825		491	452
3 x 400	23,6	3,4	81,30	10100		562	511

* Ground thermal resistivity 100°C cm/W

Electrical characteristics

Formation	Max. electrical resistance at 20°C	Conductor apparent resistance at 90°C and 50Hz	Phase reactance	Capacity at 50Hz
n° x mm ²	Ω/km	Ω/km	Ω/km	μF/km
3 x 25	1,20	1,222	0,12	0,21
3 x 35	0,868	1,113	0,11	0,23
3 x 50	0,641	0,822	0,11	0,26
3 x 70	0,443	0,568	0,10	0,29
3 x 95	0,320	0,411	0,097	0,32
3 x 120	0,253	0,325	0,094	0,36
3 x 150	0,206	0,265	0,091	0,38
3 x 185	0,164	0,211	0,088	0,42
3 x 240	0,125	0,161	0,085	0,47
3 x 300	0,100	0,130	0,084	0,52
3 x 400	0,0778	0,102	0,082	0,57

ARG7H1OR - 12/20 kV
 U_o/U: 12/20 kV
 U max: 24 kV

Technical characteristics

Formation n° x mm ²	Approx. conductor ∅ mm	Average insulation thickness mm	Max. external ∅ mm	Approx. cable weight kg/km	Current rating A	
					in air	buried*
3 x 25	6,10	5,5	48,10	2980	125	125
3 x 35	7,0	5,5	50,40	3290	150	145
3 x 50	8,1	5,5	52,80	3645	175	175
3 x 70	9,7	5,5	56,45	4210	220	210
3 x 95	11,40	5,5	60,70	4905	265	255
3 x 120	12,9	5,5	64,95	5675	305	290
3 x 150	14,3	5,5	68,05	6180	345	320
3 x 185	16,0	5,5	72,20	7100	406	360
3 x 240	18,3	5,5	78,90	8490	470	420
3 x 300	21,0	5,5	83,95	9685	590	500
3 x 400	23,6	5,5	91,40	11975	640	543

* Ground thermal resistivity 100°C cm/W

Electrical characteristics

Formation n° x mm ²	Max. electrical resistance at 20°C Ω/km	Conductor apparent resistance at 90°C and 50Hz Ω/km	Phase reactance Ω/km	Capacity at 50Hz μF/km
3 x 25	1,20	1,222	0,21	0,17
3 x 35	0,868	1,113	0,20	0,17
3 x 50	0,641	0,822	0,19	0,18
3 x 70	0,443	0,568	0,19	0,21
3 x 95	0,320	0,411	0,18	0,23
3 x 120	0,253	0,325	0,18	0,25
3 x 150	0,206	0,265	0,17	0,27
3 x 185	0,164	0,211	0,17	0,29
3 x 240	0,125	0,161	0,16	0,32
3 x 300	0,100	0,130	0,16	0,35
3 x 400	0,0778	0,102	0,16	0,39

ARG7H1OR - 18/30 kV
 U₀/U: 18/30 kV
 U max: 36 kV

Technical characteristics

Formation	Approx. conductor Ø	Average insulation thickness	Max. external Ø	Approx. cable weight	Current rating A	
					in air	buried*
n° x mm ²	mm	mm	mm	kg/km		
3 x 185	16,0	8,0	85,50	9680	406	361

Electrical characteristics

Formation	Max. electrical resistance at 20°C	Conductor apparent resistance at 90°C and 50Hz	Phase reactance	Capacity at 50Hz
n° x mm ²	Ω/km	Ω/km	Ω/km	μF/km
3 x 185	0,164	0,211	0,12	0,22

CABLES FOR A MOVING WORLD

TRATOS[®] ENERGY DNOs

Tratos Utility cables are designed and tested to meet relevant UK, European and International standards. Manufactured in state of the art manufacturing facilities, the company's purpose-built, in-house Fire, Chemical, Electrical and Physical testing facilities and laboratories deliver peace of mind to customers ensuring their choice of Utility cable products meet all statutory and regulatory requirements.



www.tratosgroup.com



ARG7H1EX cable

TRATOS ARG7H1EX-12/20 kV

Suitable for energy transmission between transformer rooms and big power users. For laying on air, into tube or open pass. Can be laid underground complying with art. 4.3.11 of CEI 11-17 standard.

FEATURES AND PERFORMANCES

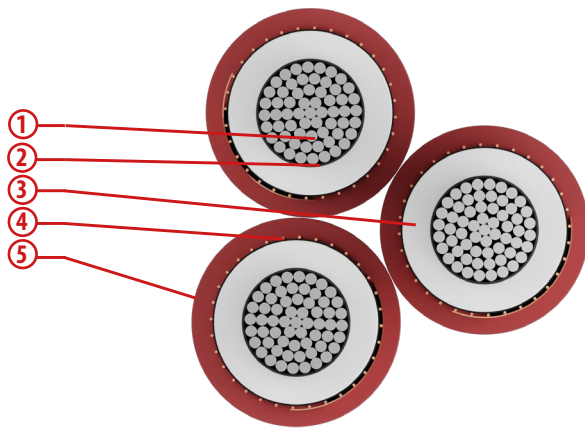

CONSTRUCTION

Bundled three-core cables, insulated with HEPR rubber of G7 quality, under PVC sheath.

1. CLASS 2, COMPACT STRANDED WIRE, ALUMINUM
2. HEPR RUBBER, G7 QUALITY, PB FREE
3. SEMICONDUCTOR LAYER: EXTRUDED, COLD STRIPPING
4. PLAIN COPPER WIRES WITH HELICALLY WOUND TAPE
5. POLYETHYLENE

Structure and electrical, physical, mechanical requirements: CEI 20-13 IEC 60502-2

- **Measurement of partial discharges** CEI 20-16 IEC 60885-3

Cable Marking

Pb free Tratos ARG7H1EX 12/20 kV [form.] [year] [trimester] [metric] FASE 1/2/3

Functional characteristics

Rated voltage	12/20 kV
Maximum operating voltage	24 kV
Max. operating temperature	90°C
Min. operating temperature	-15°C (without mechanical shocks)
Max. short circuit temperature	250°C

Installation conditions

Minimum installation temperature	0°C
Recommended min. bending radius	10 times the cable diameter
Recommended maximum tensile stress	50 N/mm ² of the cross-section of the copper

ARG7H1EX - 12/20 kV
 U_o/U: 12/20 kV
 U max: 24 kV

Technical characteristics

Formation n° x mm ²	Approx. conductor ∅ mm	Average insulation thickness mm	Average sheath thickness	Approx. core ∅	Approx. overall ∅ thickness	Approx. cable weight kg/km	Current rating A	
							in air	buried*
3 x 1 x 50	8,1	5,5	1,8	28,1	60,4	2260	174	168
3 x 1 x 70	9,7	5,5	1,8	29,8	64,1	2620	218	207
3 x 1 x 95	11,4	5,5	1,9	31,9	68,5	3010	266	247
3 x 1 x 120	12,9	5,5	2,0	34,2	73,5	3500	309	281
3 x 1 x 150	14,3	5,5	2,0	35,8	77,0	3730	352	318
3 x 1 x 185	16,0	5,5	2,1	37,8	81,3	4360	406	361
3 x 1 x 240	18,3	5,5	2,2	41,0	88,2	5175	483	418
3 x 1 x 300	21,0	5,5	2,3	44,0	94,5	5955	556	472

* Ground thermal resistivity 1 K-m/W

Electrical characteristics

Formation n° x mm ²	Max. electrical resistance at 20°C Ω/km	Conductor apparent resistance at 90°C and 50Hz Ω/km	Phase reactance Ω/km	Capacity at 50Hz μF/km
3 x 1 x 50	0,641	0,822	0,13	0,18
3 x 1 x 70	0,443	0,568	0,13	0,21
3 x 1 x 95	0,320	0,411	0,12	0,23
3 x 1 x 120	0,253	0,325	0,12	0,25
3 x 1 x 150	0,206	0,265	0,11	0,27
3 x 1 x 185	0,164	0,211	0,11	0,29
3 x 1 x 240	0,125	0,161	0,11	0,32
3 x 1 x 300	0,100	0,130	0,10	0,35

ARG7H1X cable

TRATOS ARG7H1RX-12/20 kV TRATOS ARG7H1RX-18/30 kV

Suitable for energy transmission between transformer rooms and big power users. For laying on air, into tube or open pass. Can be laid underground complying with art. 4.3.11 of CEI 11-17 standard.

FEATURES AND PERFORMANCES

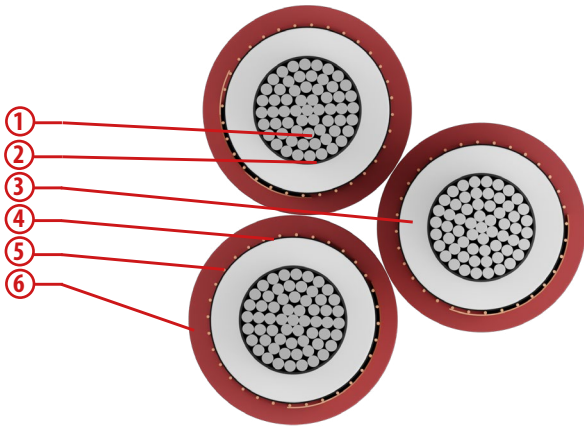

CONSTRUCTION

Bundled three-core cables, insulated with HEPR rubber of G7 quality, under PVC sheath.

1. CLASS 2, COMPACT STRANDED WIRE, ALUMINUM
2. SEMICONDUCTOR LAYER: EXTRUDED
3. HEPR RUBBER, G7 QUALITY, PB FREE
4. SEMICONDUCTOR LAYER: EXTRUDED, COLD STRIPPING
5. PLAIN COPPER WIRES WITH HELICALLY WOUND TAPE
6. PVC BASED COMPOUND, RZ QUALITY

Structure and electrical, physical, mechanical requirements: CEI 20-13 IEC 60502-2

- **Measurement of partial discharges** CEI 20-16 IEC 60885-3

Cable Marking

Pb free Tratos ARG7H1RX [rated voltage] [form.] [year] [traceability] [metric] FASE 1/2/3

Functional characteristics

Rated voltage	ARG7H1RX -12/20 kV: 12/20 kV ARG7H1RX -18/30 kV: 18/30 kV
Maximum operating voltage	ARG7H1RX -12/20 kV: 24 kV ARG7H1RX -18/30 kV: 36 kV
Max. operating temperature	90°C
Min. operating temperature	-15°C (without mechanical shocks)
Max. short circuit temperature	250°C

Installation conditions

Minimum installation temperature	0°C
Recommended min. bending radius	10 times the cable diameter
Recommended maximum tensile stress	50 N/mm ² of the cross-section of the copper

ARG7H1RX - 12/20 kV

U_o/U: 12/20 kV

U max: 24 kV

Technical characteristics

Formation n° x mm ²	Approx. conductor ∅ mm	Average insulation thickness mm	Average sheath thickness	Approx. core ∅	Approx. overall ∅ thickness	Approx. cable weight kg/km	Current rating A	
							in air	buried*
3 x 1 x 35	7,0	5,5	1,8	26,9	57,8	2250	144	142
3 x 1 x 50	8,1	5,5	1,8	28,1	60,4	2465	174	168
3 x 1 x 70	9,7	5,5	1,8	29,8	64,1	2875	218	207
3 x 1 x 95	11,4	5,5	1,9	31,9	68,5	3255	266	247
3 x 1 x 120	12,9	5,5	2,0	34,2	73,5	3780	309	281
3 x 1 x 150	14,3	5,5	2,0	35,8	77,0	4025	352	318
3 x 1 x 185	16,0	5,5	2,1	37,8	81,3	4685	406	361
3 x 1 x 240	18,3	5,5	2,2	41,0	88,2	5540	483	418
3 x 1 x 300	21,0	5,5	2,3	44,0	94,5	6365	556	472
3 x 1 x 400	23,6	5,5	2,4	43,7	96,8	7913	640	543

* Ground thermal resistivity 1 K·m/W

Electrical characteristics

Formation n° x mm ²	Max. electrical resistance at 20°C Ω/km	Conductor apparent resistance at 90°C and 50Hz Ω/km	Phase reactance Ω/km	Capacity at 50Hz μF/km
3 x 1 x 35	0,868	1,113	0,14	0,17
3 x 1 x 50	0,641	0,822	0,13	0,18
3 x 1 x 70	0,443	0,568	0,13	0,21
3 x 1 x 95	0,320	0,411	0,12	0,23
3 x 1 x 120	0,253	0,325	0,12	0,25
3 x 1 x 150	0,206	0,265	0,11	0,27
3 x 1 x 185	0,164	0,211	0,11	0,29
3 x 1 x 240	0,125	0,161	0,11	0,32
3 x 1 x 300	0,100	0,130	0,10	0,35
3 x 1 x 400	0,0778	0,102	0,099	0,39

TRATOS General Cables®

ARG7H1RX - 18/30 kV
 U₀/U: 18/30 kV
 U max: 36 kV

Technical characteristics

Formation n° x mm ²	Approx. conductor ∅ mm	Average insulation thickness mm	Average sheath thickness	Approx. core ∅	Approx. overall ∅ thickness	Approx. cable weight kg/km	Current rating A	
							in air	buried*
3 x 1 x 35	7,0	8,0	1,9	33,5	72,0	3150	144	142
3 x 1 x 50	8,1	8,0	2,0	34,1	73,3	3480	174	168
3 x 1 x 70	9,7	8,0	2,0	36,2	77,8	3880	218	207
3 x 1 x 95	11,4	8,0	2,1	38,2	82,1	4355	266	247
3 x 1 x 120	12,9	8,0	2,2	40,0	86,0	5020	309	281
3 x 1 x 150	14,3	8,0	2,2	41,0	88,2	5385	352	318
3 x 1 x 185	16,0	8,0	2,3	43,1	92,7	6040	406	361
3 x 1 x 240	18,3	8,0	2,4	45,0	96,8	6910	483	418

* Ground thermal resistivity 1 K-m/W

Electrical characteristics

Formation n° x mm ²	Max. electrical resistance at 20°C Ω/km	Conductor apparent resistance at 90°C and 50Hz Ω/km	Phase reactance Ω/km	Capacity at 50Hz μF/km
3 x 1 x 35	0,868	1,113	0,14	0,17
3 x 1 x 50	0,641	0,822	0,13	0,18
3 x 1 x 70	0,443	0,568	0,13	0,21
3 x 1 x 95	0,320	0,411	0,12	0,23
3 x 1 x 120	0,253	0,325	0,12	0,25
3 x 1 x 150	0,206	0,265	0,11	0,27
3 x 1 x 185	0,164	0,211	0,11	0,29
3 x 1 x 240	0,125	0,161	0,11	0,32

C A B L E S F O R A M O V I N G W O R L D

TRATOS[®] ENERGY DNOs

Tratos Utility cables are designed and tested to meet relevant UK, European and International standards. Manufactured in state of the art manufacturing facilities, the company's purpose-built, in-house Fire, Chemical, Electrical and Physical testing facilities and laboratories deliver peace of mind to customers ensuring their choice of Utility cable products meet all statutory and regulatory requirements.



www.tratosgroup.com



RG7OZR | RG7H1OZR cable

TRATOS RG7OZR-1,8/3 ÷ 3,6/6 kV TRATOS RG7H1OZR-6/10 ÷ 18/30 kV

Suitable for energy transmission between transformer rooms and big power users. For laying on air, into tube or open pass. Can be laid underground, also if not protected, complying with art. 4.3.11 of CEI 11-17 standard.

FEATURES AND PERFORMANCES

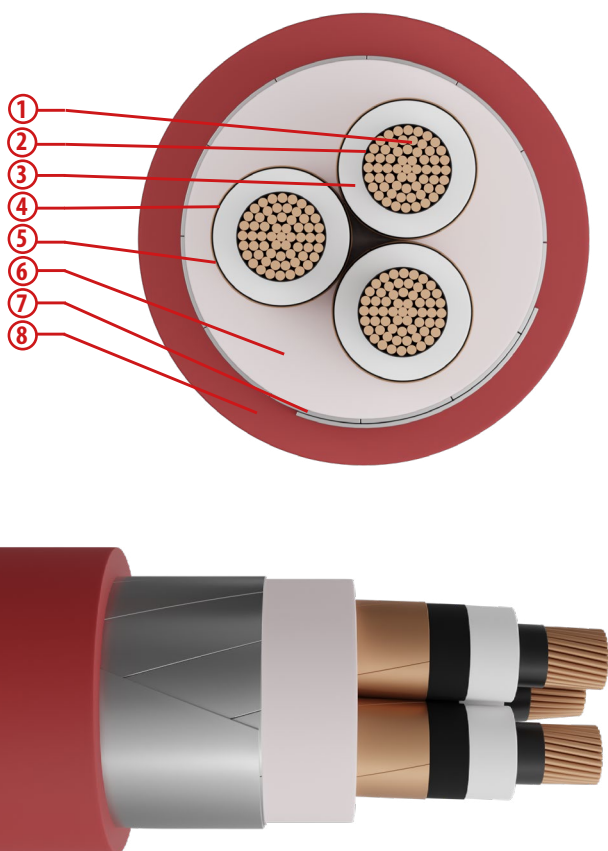

CONSTRUCTION

Three-pole cables, insulated with HEPR rubber of G7 quality, armed with galvanized flat steel wires, under PVC sheath.

1. CLASS 2, COMPACT STRANDED WIRE, PLAIN COPPER
2. SEMICONDUCTOR LAYER: EXTRUDED (ONLY CABLES UO/U ≥ 6/10 KV)
3. HEPR RUBBER, G7 QUALITY, PB FREE
4. SEMICONDUCTOR LAYER: EXTRUDED, COLD STRIPPING (ONLY CABLES UO/U ≥ 6/10 KV)
5. SCREEN(*): PLAIN COPPER TAPES WRAPPED (ONLY CABLES RG7H1OZR)
6. PVC BASED COMPOUND EXTRUDED, PENETRATING BETWEEN THE CORES
7. ARMOUR(*): GALVANIZED FLAT STEEL WIRES, WITH HELICALLY WOUNDED TAPE
8. PVC BASED COMPOUND, RZ QUALITY

Structure and electrical, physical, mechanical requirements: CEI 20-13 IEC 60502

- **Measurement of partial discharges** CEI 20-16
- **Flame propagation** EN 60332-1-2
- **Fire propagation** EN 60332-3-24
- **Corrosive gases or halogens** EN 50267-2-1

Cable Marking

Pb free Tratos RG7OZR [rated voltage] [form.] [year] [traceability] [metric]

Pb free Tratos RG7H1OZR [rated voltage] [form.] [year] [traceability] [metric]

Functional characteristics

Rated voltage U _o /U	RG7OZR: 1,8/3 - 3,6/6 kV RG7H1OZR: 6/10 ÷ 18/30 kV
Max. operating temperature	90°C
Min. operating temperature	-15°C (without mechanical shocks)
Max. short circuit temperature	250°C

Installation conditions

Minimum installation temperature	0°C
Recommended min. bending radius	16 times the cable diameter
Recommended maximum tensile stress	60 N/mm ² of the cross-section of the copper

RG7OZR - 1,8/3 kV
 U_o/U: 1,8/3 kV
 U max: 3,6 kV

Technical characteristics

Formation n° x mm ²	Approx. conductor Ø mm	Average insulation thickness mm	Max. external Ø mm	Approx. cable weight kg/km	Current rating A	
					in air	buried*
3 x 10	4,0	2,0	29,0	1370	81	89
3 x 16	4,8	2,0	31,0	1690	105	115
3 x 25	6,0	2,0	34,0	2100	138	148
3 x 35	7,0	2,0	36,5	2500	166	175
3 x 50	8,1	2,0	39,5	3035	200	208
3 x 70	9,7	2,0	43,0	3880	250	255
3 x 95	11,4	2,0	47,5	4900	305	303
3 x 120	12,9	2,0	51,5	5900	351	345
3 x 150	14,3	2,0	54,5	6850	398	385
3 x 185	16,0	2,0	58,5	8180	455	435
3 x 240	18,3	2,0	64,5	10300	540	505
3 x 300	21,0	2,0	77,0	12500	615	565
3 x 400	23,2	2,0	78,5	15500	715	645

* Ground thermal resistivity 100°C cm/W

Electrical characteristics

Formation n° x mm ²	Max. electrical resistance at 20°C Ω/km	Conductor apparent resistance at 90°C and 50Hz Ω/km	Phase reactance Ω/km	Capacity at 50Hz µF/km
3 x 10	1,83	2,34	0,11	0,19
3 x 16	1,15	1,47	0,10	0,23
3 x 25	0,727	0,927	0,097	0,27
3 x 35	0,524	0,669	0,093	0,30
3 x 50	0,387	0,494	0,088	0,34
3 x 70	0,268	0,342	0,084	0,40
3 x 95	0,193	0,247	0,081	0,45
3 x 120	0,153	0,197	0,079	0,50
3 x 150	0,124	0,159	0,077	0,55
3 x 185	0,0991	0,129	0,076	0,60
3 x 240	0,0754	0,0990	0,074	0,68
3 x 300	0,0601	0,0807	0,072	0,75
3 x 400	0,0470	0,0651	0,071	0,83

TRATOS General Cables®

RG7OZR - 3,6/6 kV
 U₀/U: 3,6/6 kV
 U max: 7,2 kV

Technical characteristics

Formation n° x mm ²	Approx. conductor Ø mm	Average insulation thickness mm	Max. external Ø mm	Approx. cable weight kg/km	Current rating A	
					in air	buried*
3 x 10	4,0	3,0	33,5	1695	78	85
3 x 16	4,8	3,0	36,5	1970	103	108
3 x 25	6,0	3,0	39,0	2580	130	138
3 x 35	7,0	3,0	41,5	3040	160	165
3 x 50	8,1	3,0	44,0	3500	190	195
3 x 70	9,7	3,0	48,5	4400	235	240
3 x 95	11,4	3,0	52,5	5555	285	285
3 x 120	12,9	3,0	56,5	6545	330	330
3 x 150	14,3	3,0	59,5	7450	373	365
3 x 185	16,0	3,0	64,5	8900	430	415
3 x 240	18,3	3,0	69,5	11000	503	480
3 x 300	21,0	3,0	76,5	13250	577	540
3 x 400	23,2	3,0	83,5	16200	670	620

* Ground thermal resistivity 100°C cm/W

Electrical characteristics

Formation n° x mm ²	Max. electrical resistance at 20°C Ω/km	Conductor apparent resistance at 90°C and 50Hz Ω/km	Phase reactance Ω/km	Capacity at 50Hz µF/km
3 x 10	1,83	2,34	0,12	0,15
3 x 16	1,15	1,47	0,12	0,17
3 x 25	0,727	0,927	0,11	0,20
3 x 35	0,524	0,669	0,10	0,23
3 x 50	0,387	0,494	0,097	0,26
3 x 70	0,268	0,342	0,092	0,30
3 x 95	0,193	0,247	0,089	0,33
3 x 120	0,153	0,197	0,086	0,37
3 x 150	0,124	0,159	0,084	0,40
3 x 185	0,0991	0,129	0,082	0,44
3 x 240	0,0754	0,0990	0,079	0,49
3 x 300	0,0601	0,0807	0,077	0,54
3 x 400	0,0470	0,0651	0,075	0,60

RG7H1OZR - 6/10 kV

U_o/U: 6/10 kV

U max: 12 kV

Technical characteristics

Formation n° x mm ²	Approx. conductor Ø mm	Average insulation thickness mm	Max. external Ø mm	Approx. cable weight kg/km	Current rating A	
					in air	buried*
3 x 10	4,0	3,4	41,5	2665	71	77
3 x 16	4,8	3,4	44,0	3065	105	111
3 x 25	6,0	3,4	47,3	3555	143	145
3 x 35	7,0	3,4	50,0	4080	170	172
3 x 50	8,1	3,4	53,0	4735	205	203
3 x 70	9,7	3,4	57,4	5685	253	250
3 x 95	11,4	3,4	60,3	6880	305	296
3 x 120	12,9	3,4	65,3	8135	353	337
3 x 150	14,3	3,4	68,5	9360	393	375
3 x 185	16,0	3,4	72,5	10920	447	425
3 x 240	18,3	3,4	78,6	13480	525	490
3 x 300	21,0	3,4	84,6	16020	595	550
3 x 400	23,2	3,4	90,6	16865	677	620

* Ground thermal resistivity 100°C cm/W

Electrical characteristics

Formation n° x mm ²	Max. electrical resistance at 20°C Ω/km	Conductor apparent resistance at 90°C and 50Hz Ω/km	Phase reactance Ω/km	Capacity at 50Hz μF/km
3 x 10	1,83	2,34	0,14	0,16
3 x 16	1,15	1,47	0,13	0,18
3 x 25	0,727	0,927	0,12	0,21
3 x 35	0,524	0,669	0,11	0,23
3 x 50	0,387	0,494	0,11	0,26
3 x 70	0,268	0,342	0,10	0,29
3 x 95	0,193	0,247	0,097	0,32
3 x 120	0,153	0,197	0,094	0,36
3 x 150	0,124	0,159	0,091	0,38
3 x 185	0,0991	0,129	0,088	0,42
3 x 240	0,0754	0,0990	0,085	0,47
3 x 300	0,0601	0,0807	0,084	0,52
3 x 400	0,0470	0,0651	0,082	0,57

RG7H1OZR - 8,7/15 kV
 U₀/U: 8,7/15 kV
 U max: 17,5 kV

Technical characteristics

Formation n° x mm ²	Approx. conductor Ø mm	Average insulation thickness mm	Max. external Ø mm	Approx. cable weight kg/km	Current rating A	
					in air	buried*
3 x 16	4,8	4,5	49,5	3700	95	98
3 x 25	6,0	4,5	52,5	4295	142	140
3 x 35	7,0	4,5	55,0	4805	171	168
3 x 50	8,1	4,5	57,3	5500	205	200
3 x 70	9,7	4,5	61,5	6559	252	245
3 x 95	11,4	4,5	65,5	7785	303	290
3 x 120	12,9	4,5	69,5	9080	347	327
3 x 150	14,3	4,5	72,5	10355	390	365
3 x 185	16,0	4,5	76,5	11050	446	413
3 x 240	18,3	4,5	82,5	13300	520	476
3 x 300	21,0	4,5	88,6	15850	595	535

* Ground thermal resistivity 100°C cm/W

Electrical characteristics

Formation n° x mm ²	Max. electrical resistance at 20°C Ω/km	Conductor apparent resistance at 90°C and 50Hz Ω/km	Phase reactance Ω/km	Capacity at 50Hz µF/km
3 x 16	1,15	1,47	0,14	0,15
3 x 25	0,727	0,927	0,13	0,18
3 x 35	0,524	0,669	0,12	0,19
3 x 50	0,387	0,494	0,12	0,21
3 x 70	0,268	0,342	0,11	0,24
3 x 95	0,193	0,247	0,10	0,26
3 x 120	0,153	0,197	0,10	0,29
3 x 150	0,124	0,159	0,097	0,31
3 x 185	0,0991	0,129	0,094	0,34
3 x 240	0,0754	0,0990	0,090	0,37
3 x 300	0,0601	0,0807	0,088	0,42

RG7H1OZR - 12/20 kV
 U_o/U: 12/20 kV
 U max: 24 kV

Technical characteristics

Formation n° x mm ²	Approx. conductor ∅ mm	Average insulation thickness mm	Max. external ∅ mm	Approx. cable weight kg/km	Current rating A	
					in air	buried*
3 x 35	7,0	5,5	59,5	4975	173	177
3 x 50	8,1	5,5	62,5	6175	203	208
3 x 70	9,7	5,5	67,0	7305	251	255
3 x 95	11,4	5,5	70,5	8540	303	301
3 x 120	12,9	5,5	75,0	9925	348	342
3 x 150	14,3	5,5	78,0	11270	393	381
3 x 185	16,0	5,5	81,5	12935	448	431
3 x 240	18,3	5,5	88,0	15625	520	495
3 x 300	21,0	5,5	94,0	18300	595	550

* Ground thermal resistivity 100°C cm/W

Electrical characteristics

Formation n° x mm ²	Max. electrical resistance at 20°C Ω/km	Conductor apparent resistance at 90°C and 50Hz Ω/km	Phase reactance Ω/km	Capacity at 50Hz μF/km
3 x 35	0,524	0,669	0,13	0,17
3 x 50	0,387	0,494	0,12	0,18
3 x 70	0,268	0,342	0,11	0,21
3 x 95	0,193	0,247	0,10	0,23
3 x 120	0,153	0,197	0,10	0,25
3 x 150	0,124	0,159	0,10	0,27
3 x 185	0,0991	0,129	0,098	0,29
3 x 240	0,0754	0,0990	0,094	0,32
3 x 300	0,0601	0,0807	0,092	0,35

TRATOS General Cables®

RG7H1OZR - 18/30 kV
 U₀/U: 18/30 kV
 U max: 36 kV

Technical characteristics

Formation n° x mm ²	Approx. conductor ∅ mm	Average insulation thickness mm	Max. external ∅ mm	Approx. cable weight kg/km	Current rating A	
					in air	buried*
3 x 35	7,0	5,5	74,5	7525	171	168
3 x 50	8,1	8,0	76,0	8450	202	205
3 x 70	9,7	8,0	79,5	9610	250	252
3 x 95	11,4	8,0	83,5	10980	302	300
3 x 120	12,9	8,0	88,0	12680	345	340
3 x 150	14,3	8,0	90,0	14130	390	378
3 x 185	16,0	8,0	95,0	15645	445	428

* Ground thermal resistivity 1 K-m/W

Electrical characteristics

Formation n° x mm ²	Max. electrical resistance at 20°C Ω/km	Conductor apparent resistance at 90°C and 50Hz Ω/km	Phase reactance Ω/km	Capacity at 50Hz μF/km
3 x 35	0,524	0,669	0,13	0,17
3 x 50	0,387	0,494	0,13	0,15
3 x 70	0,268	0,342	0,13	0,16
3 x 95	0,193	0,247	0,12	0,18
3 x 120	0,153	0,197	0,12	0,19
3 x 150	0,124	0,159	0,11	0,20
3 x 185	0,0991	0,129	0,11	0,22

C A B L E S F O R A M O V I N G W O R L D

TRATOS[®] ENERGY DNOs

Tratos Utility cables are designed and tested to meet relevant UK, European and International standards. Manufactured in state of the art manufacturing facilities, the company's purpose-built, in-house Fire, Chemical, Electrical and Physical testing facilities and laboratories deliver peace of mind to customers ensuring their choice of Utility cable products meet all statutory and regulatory requirements.



www.tratosgroup.com



RG7H1ONR cable

TRATOS RG7H1ONR- 6/10 kV & 12/20 kV

Suitable for energy transmission between transformer rooms and big power users. For laying on air, into tube or open pass. Can be laid underground, also if not protected, complying with art. 4.3.11 of CEI 11-17 standard.

FEATURES AND PERFORMANCES

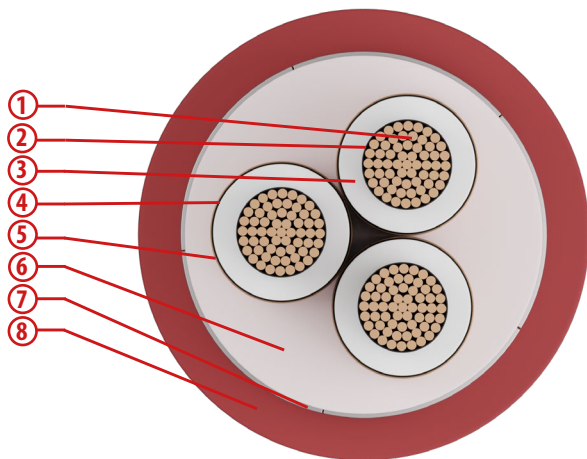

CONSTRUCTION

Three-pole cables, insulated with HEPR rubber of G7 quality, armed with galvanized flat steel tapes, under PVC sheath.

1. CLASS 2, COMPACT STRANDED WIRE, PLAIN COPPER
2. SEMICONDUCTOR LAYER: EXTRUDED
3. HEPR RUBBER, G7 QUALITY, PB FREE
4. SEMICONDUCTOR LAYER: EXTRUDED, COLD STRIPPING
5. PLAIN ANNEALED COPPER TAPES
6. PVC BASED COMPOUND EXTRUDED, PENETRATING BETWEEN THE CORES
7. GALVANIZED STEEL TAPES
8. PVC BASED COMPOUND, RZ QUALITY, RESISTANT TO HYDROCARBONS

Structure and electrical, physical, mechanical requirements: CEI 20-13 IEC 60502-2

- **Measurement of partial discharges** CEI 20-16
- **Flame propagation** EN 60332-1-2

Cable Marking

Pb free Tratos RG7H1ONR [rated voltage] [form.] [year] [traceability] [metric]

Functional characteristics

Rated voltage U ₀ /U	6/10
Max. U voltage	12 kV
Max. operating temperature	90°C
Min. operating temperature	-15°C (without mechanical shocks)
Max. short circuit temperature	250°C

Installation conditions

Minimum installation temperature	0°C
Recommended min. bending radius	16 times the cable diameter
Recommended maximum tensile stress	60 N/mm ² of the cross-section of the copper

RG7H1ONR - 6/10 kV
 U_o/U: 6/10 kV
 U max: 12 kV

Technical characteristics

Formation n° x mm ²	Approx. conductor ∅ mm	Average insulation thickness mm	Approx. external ∅ mm	Approx. cable weight kg/km	Current rating A	
					in air	buried*
3 x 16	4,8	3,4	39,5	2805	105	111
3 x 25	6,0	3,4	41,4	3055	143	145
3 x 35	7,0	3,4	44,9	3805	170	172
3 x 50	8,1	3,4	47,4	4415	205	203
3 x 70	9,7	3,4	51,5	5415	253	250
3 x 95	11,4	3,4	55,5	6545	305	296
3 x 120	12,9	3,4	60,1	7855	353	375
3 x 150	14,3	3,4	63,8	9000	393	375
3 x 185	16,0	3,4	67,9	10510	447	425
3 x 240	18,3	3,4	74,9	13005	525	490
3 x 300	21,0	3,4	80,5	15460	595	550

* Ground thermal resistivity 100°C cm/W

Electrical characteristics

Formation n° x mm ²	Max. electrical resistance at 20°C Ω/km	Conductor apparent resistance at 90°C and 50Hz Ω/km	Phase reactance Ω/km	Capacity at 50Hz μF/km
3 x 16	1,15	1,47	0,13	0,18
3 x 25	0,727	0,927	0,12	0,21
3 x 35	0,524	0,669	0,11	0,23
3 x 50	0,387	0,494	0,11	0,26
3 x 70	0,268	0,342	0,10	0,29
3 x 95	0,193	0,247	0,097	0,32
3 x 120	0,153	0,197	0,094	0,36
3 x 150	0,124	0,159	0,091	0,38
3 x 185	0,0991	0,129	0,088	0,42
3 x 240	0,0754	0,0990	0,085	0,47
3 x 300	0,0601	0,0807	0,084	0,52

TRATOS General Cables®

RG7H1ONR - 12/20 kV
 U₀/U: 12/20 kV
 U max: 24 kV

Technical characteristics

Formation n° x mm ²	Approx. conductor Ø mm	Average insulation thickness mm	Approx. external Ø mm	Approx. cable weight kg/km	Current rating A	
					in air	buried*
3 x 35	7,0	5,5	49,3	5300	173	177
3 x 50	8,1	5,5	51,7	5970	203	208
3 x 70	9,7	5,5	55,3	7060	251	255
3 x 95	11,4	5,5	59,2	8340	303	301
3 x 120	12,9	5,5	63,4	9710	348	342
3 x 150	14,3	5,5	66,8	11010	393	381
3 x 185	16,0	5,5	70,5	12670	448	431
3 x 240	18,3	5,5	76,8	15450	520	495
3 x 300	21,0	5,5	82,3	18275	595	555

* Ground thermal resistivity 100°C cm/W

Electrical characteristics

Formation n° x mm ²	Max. electrical resistance at 20°C Ω/km	Conductor apparent resistance at 90°C and 50Hz Ω/km	Phase reactance Ω/km	Capacity at 50Hz µF/km
3 x 35	0,524	0,669	0,13	0,17
3 x 50	0,387	0,494	0,12	0,18
3 x 70	0,268	0,342	0,11	0,21
3 x 95	0,193	0,247	0,10	0,23
3 x 120	0,153	0,197	0,10	0,25
3 x 150	0,124	0,159	0,10	0,27
3 x 185	0,0991	0,129	0,098	0,29
3 x 240	0,0754	0,0990	0,094	0,32
3 x 300	0,0601	0,0807	0,092	0,35

C A B L E S F O R A M O V I N G W O R L D

TRATOS[®] ENERGY DNOs

Tratos Utility cables are designed and tested to meet relevant UK, European and International standards. Manufactured in state of the art manufacturing facilities, the company's purpose-built, in-house Fire, Chemical, Electrical and Physical testing facilities and laboratories deliver peace of mind to customers ensuring their choice of Utility cable products meet all statutory and regulatory requirements.



www.tratosgroup.com



RG7H1RNRX cable

TRATOS RG7H1RNRX-12/20 kV

Suitable for energy transmission between transformer rooms and big power users. For laying on air, into tube or open pass. Can be laid underground, also if not protected, complying with art. 4.3.11 of CEI 11-17 standard.

FEATURES AND PERFORMANCES

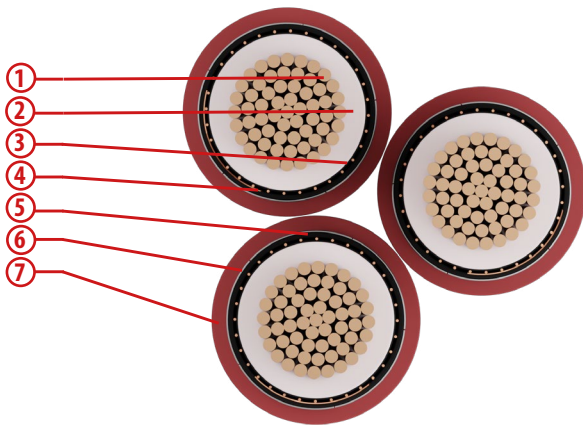

CONSTRUCTION

1. COPPER, COMPACT STRANDED WIRE, CLASS 2
2. SEMICONDUCTOR LAYER: EXTRUDED
3. HEPR RUBBER, G7 QUALITY, PB FREE
4. SEMICONDUCTOR LAYER: EXTRUDED, COLD STRIPPING
5. PLAIN COPPER WIRES WITH HELICALLY WOUND TAPE
6. ALUMINUM TAPES WRAPPED
7. PVC BASED COMPOUND, RZ QUALITY

Structure and electrical, physical, mechanical requirements: CEI 20-13 IEC 60502 EN 60228

- Flame propagation EN 60332-1-2
- Fire propagation CEI 20-22 III

Cable Marking

Pb free Tratos RG7H1RNRX [rated voltage] [form.] [year] [traceability] [metric] FASE 1/2/3

Functional characteristics

Rated voltage U ₀ /U	12/20 kV
Maximum operating voltage	24 kV
Max. operating temperature	90°C
Min. operating temperature	-15°C (without mechanical shocks)
Max. short circuit temperature	250°C

Installation conditions

Minimum installation temperature	0°C
Recommended min. bending radius	10 times the cable diameter
Recommended maximum tensile stress	50 N/mm ² of the cross-section of the copper

Technical characteristics

Formation n° x mm ²	Approx. conductor Ø mm	Average insulation thickness mm	Average sheath thickness mm	Approx. external Ø mm	Approx. cable weight kg/km	Current rating A	
						in air	buried*
3 x 1 x 50	8,1	5,5	1,9	65,2	4050	230	216
3 x 1 x 70	9,7	5,5	2,0	69,5	4935	285	265
3 x 1 x 95	11,4	5,5	2,1	75,7	6175	348	315

(*) Permissible current rating values are according to:

- Ground thermal resistivity: 1 K.m/W
- Ambient temperature 20°C
- laying depth of 0,8 m

Electrical characteristics

Formation n° x mm ²	Max. electrical resistance at 20°C Ω/km	Conductor apparent resistance at 90°C and 50Hz Ω/km	Phase reactance Ω/km	Capacity at 50Hz µF/km
3 x 1 x 50	0,387	0,494	0,13	0,18
3 x 1 x 70	0,268	0,342	0,13	0,21
3 x 1 x 95	0,193	0,247	0,12	0,23

ARG7H1RNR | ARG7H1RNRX cable

TRATOS ARG7H1RNR-12/20 kV ÷ 18/30 kV TRATOS ARG7H1RNRX-12/20 kV ÷ 18/30 kV

Suitable for energy transmission between transformer rooms and big power users. For laying on air, into tube or open pass. Can be laid underground, also if not protected, complying with art. 4.3.11 of CEI 11-17 standard.

FEATURES AND PERFORMANCES

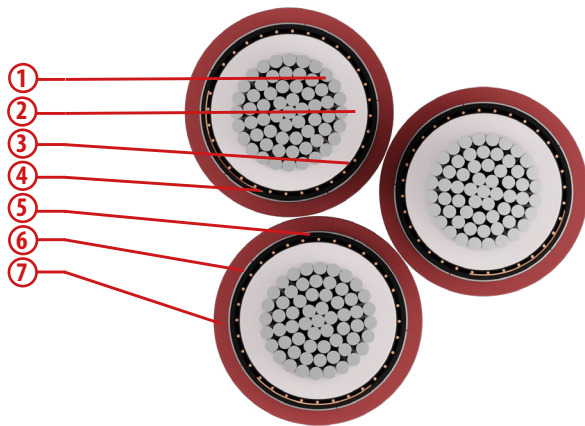

CONSTRUCTION

ARG7H1RNR

Single-core cables, insulated with HEPR rubber of G7 quality, under PVC sheath.

ARG7H1RNRX

Bundled three-core cables, insulated with HEPR rubber of G7 quality, under PVC sheath

1. CLASS 2, COMPACT STRANDED WIRE, ALUMINUM
2. SEMICONDUCTOR LAYER: EXTRUDED
3. HEPR RUBBER, G7 QUALITY, PB FREE
4. SEMICONDUCTOR LAYER: EXTRUDED, COLD STRIPPING
5. PLAIN COPPER WIRES WITH HELICALLY WOUND TAPE
6. ALUMINUM TAPES WRAPPED
7. PVC BASED COMPOUND, RZ QUALITY

Structure and electrical, physical, mechanical requirements: CEI 20-13 IEC 60502 EN 60228

- Flame propagation EN 60332-1-2
- Fire propagation CEI 20-22 III

Cable Marking

Pb free Tratos ARG7H1RNR [rated voltage] [form.] [year] [traceability] [metric]

Pb free Tratos ARG7H1RNRX [rated voltage] [form.] [year] [traceability] [metric] FASE 1/2/3

Functional characteristics	
Rated voltage U ₀ /U	ARG7H1RNR -12/20 kV 12/20 kV ARG7H1RNR -18/30 kV 18/30 kV ARG7H1RNRX -12/20 kV: 12/20 kV ARG7H1RNRX -18/30 kV: 18/30 kV
Maximum operating voltage	ARG7H1RNR -12/20 kV 24 kV ARG7H1RNR -18/30 kV 36 kV ARG7H1RNRX -12/20 kV: 24 kV ARG7H1RNRX -18/30 kV: 36 kV
Max. operating temperature	90°C
Min. operating temperature	-15°C (without mechanical shocks)
Max. short circuit temperature	250°C

ARG7H1RNR Installation conditions	
Minimum installation temperature	0°C
Recommended min. bending radius	14 times the cable diameter
Recommended maximum tensile stress	50 N/mm ² of the cross-section of the copper

ARG7H1RNRX Installation conditions	
Minimum installation temperature	0°C
Recommended min. bending radius	10 times the cable diameter
Recommended maximum tensile stress	50 N/mm ² of the cross-section of the copper

ARG7H1RNR - 12/20 kV

U_o/U: 12/20 kV

U max: 24 kV

Technical characteristics

Formation	Approx. conductor Ø	Average insulation thickness	Max. external Ø	Approx. cable weight	Current rating			
					in air		buried*	
n° x mm ²	mm	mm	mm	kg/km	trefoil	flat	trefoil	flat
1 x 50	8,2	5,5	29,5	1100	174	183	168	177
1 x 70	9,8	5,5	31,5	1275	218	229	207	218
1 x 95	11,45	5,5	34,35	1535	266	280	247	260
1 x 120	12,9	5,5	36,2	1720	309	325	281	296
1 x 150	14,2	5,5	37,7	1840	352	371	318	335
1 x 185	16,0	5,5	39,5	2070	406	427	361	380
1 x 240	18,4	5,5	42,7	2420	483	508	418	440
1 x 300	20,5	5,5	45,0	2725	547	576	472	497
1 x 400	23,6	5,5	48,7	3355	640	674	543	572
1 x 500	26,55	5,5	53,15	4010	740	779	621	654
1 x 630	30,1	5,5	57,1	4690	862	907	706	743

* Ground thermal resistivity 100°C cm/W

Electrical characteristics

Formation	Max. electrical resistance at 20°C	Conductor apparent resistance at 90°C and 50Hz		Phase reactance		Capacity at 50Hz
		Ω/km		Ω/km		
n° x mm ²	Ω/km	trefoil	flat	trefoil	flat	μF/km
1 x 50	0,641	0,822	0,822	0,13	0,19	0,18
1 x 70	0,443	0,568	0,568	0,13	0,19	0,21
1 x 95	0,320	0,411	0,411	0,12	0,18	0,23
1 x 120	0,253	0,325	0,325	0,12	0,18	0,25
1 x 150	0,206	0,265	0,265	0,11	0,17	0,27
1 x 185	0,164	0,211	0,211	0,11	0,17	0,29
1 x 240	0,125	0,161	0,161	0,11	0,16	0,32
1 x 300	0,100	0,130	0,129	0,10	0,16	0,35
1 x 400	0,0778	0,102	0,101	0,099	0,16	0,39
1 x 500	0,0605	0,0801	0,0794	0,096	0,15	0,43
1 x 630	0,0469	0,0635	0,0625	0,093	0,15	0,49

TRATOS General Cables®

ARG7H1RNR - 18/30 kV
 U₀/U: 18/30 kV
 U max: 36 kV

Technical characteristics

Formation	Approx. conductor Ø	Average insulation thickness	Max. external Ø	Approx. cable weight	Current rating			
					in air		buried*	
					trefoil	flat	trefoil	flat
n° x mm ²	mm	mm	mm	kg/km				
1 x 50	8,2	8,0	36,1	1600	174	183	168	177
1 x 70	9,8	8,0	38,2	1795	218	229	207	218
1 x 95	11,45	8,0	39,7	1960	266	280	247	260
1 x 120	12,9	8,0	42,4	2245	309	325	281	296
1 x 150	14,2	8,0	43,7	2405	352	371	318	335
1 x 185	16,0	8,0	45,7	2625	406	427	361	380
1 x 240	18,4	8,0	48,3	2985	483	508	418	440
1 x 300	20,5	8,0	51,8	3345	547	576	472	497
1 x 400	23,6	8,0	55,2	4005	640	674	543	572
1 x 500	26,55	8,0	58,35	4440	740	779	621	654
1 x 630	30,1	8,0	62,8	5135	862	907	706	743

* Ground thermal resistivity 100°C cm/W

Electrical characteristics

Formation	Max. electrical resistance at 20°C	Conductor apparent resistance at 90°C and 50Hz		Phase reactance		Capacity at 50Hz
		Ω/km		Ω/km		
n° x mm ²	Ω/km	trefoil	flat	trefoil	flat	μF/km
1 x 50	0,641	0,822	0,822	0,15	0,20	0,15
1 x 70	0,443	0,568	0,568	0,14	0,20	0,16
1 x 95	0,320	0,411	0,411	0,13	0,19	0,18
1 x 120	0,253	0,325	0,325	0,13	0,18	0,19
1 x 150	0,206	0,265	0,265	0,12	0,18	0,20
1 x 185	0,164	0,211	0,211	0,12	0,12	0,22
1 x 240	0,125	0,161	0,161	0,11	0,17	0,24
1 x 300	0,100	0,130	0,129	0,11	0,17	0,27
1 x 400	0,0778	0,102	0,101	0,11	0,16	0,29
1 x 500	0,0605	0,0801	0,0794	0,10	0,16	0,32
1 x 630	0,0469	0,0635	0,0625	0,099	0,16	0,36

ARG7H1RNRX - 12/20 kV
 U₀/U: 12/20 kV
 U max: 24 kV

Technical characteristics

Formation	Approx. conductor Ø	Average insulation thickness	Average sheath thickness	Max. external Ø	Approx. cable weight	Current rating	
						in air	buried*
n° x mm ²	mm	mm	mm	mm	kg/km	A	A
3 x 1 x 50	8,2	5,5	1,9	63,5	3315	174	168
3 x 1 x 70	9,8	5,5	2,0	67,8	3835	218	207
3 x 1 x 95	11,45	5,5	2,1	73,9	4620	266	247
3 x 1 x 120	12,9	5,5	2,1	77,9	5175	309	281
3 x 1 x 150	14,2	5,5	2,2	81,1	5535	352	318
3 x 1 x 185	16,0	5,5	2,2	85,0	6225	406	361
3 x 1 x 240	18,4	5,5	2,3	91,9	7290	483	418

(*) Permissible current rating values are according to:
 - Ground thermal resistivity: 1 K·m/W
 - Ambient temperature 20°C
 - laying depth of 0,8 m

Electrical characteristics

Formation	Max. electrical resistance at 20°C	Conductor apparent resistance at 90°C and 50Hz	Phase reactance	Capacity at 50Hz	Thermal current of circuit (*)
n° x mm ²	Ω/km	Ω/km	Ω/km	μF/km	kA
3 x 1 x 50	0,641	0,822	0,13	0,18	6,5
3 x 1 x 70	0,443	0,568	0,13	0,21	9,1
3 x 1 x 95	0,320	0,411	0,12	0,23	12,3
3 x 1 x 120	0,253	0,325	0,12	0,25	15,6
3 x 1 x 150	0,206	0,265	0,11	0,27	19,5
3 x 1 x 185	0,164	0,211	0,11	0,29	24,0
3 x 1 x 240	0,125	0,161	0,11	0,32	31,2

(*) Short circuit duration 0,5 seconds

TRATOS General Cables®

ARG7H1RNRX - 18/30 kV
 U₀/U: 18/30 kV
 U max: 36 kV

Technical characteristics

Formation	Approx. conductor Ø	Average insulation thickness	Average sheath thickness	Max. external Ø	Approx. cable weight	Current rating	
						in air	buried*
n° x mm ²	mm	mm	mm	mm	kg/km	A	A
3 x 1 x 50	8,2	8,0	2,1	77,7	4810	174	168
3 x 1 x 70	9,8	8,0	2,2	82,2	5400	218	207
3 x 1 x 95	11,45	8,0	2,2	85,4	5895	266	247
3 x 1 x 120	12,9	8,0	2,3	91,2	6755	309	281
3 x 1 x 150	14,2	8,0	2,4	94,0	7235	352	318
3 x 1 x 185	16,0	8,0	2,4	98,3	7910	406	361
3 x 1 x 240	18,4	8,0	2,5	103,9	8980	483	418

(*) Permissible current rating values are according to:
 - Ground thermal resistivity: 1 K-m/W
 - Ambient temperature 20°C
 - laying depth of 0,8 m

Electrical characteristics

Formation	Max. electrical resistance at 20°C	Conductor apparent resistance at 90°C and 50Hz	Phase reactance	Capacity at 50Hz	Thermal current of circuit (*)
n° x mm ²	Ω/km	Ω/km	Ω/km	μF/km	kA
3 x 1 x 50	0,641	0,822	0,15	0,15	6,5
3 x 1 x 70	0,443	0,568	0,14	0,16	9,1
3 x 1 x 95	0,320	0,411	0,13	0,18	12,3
3 x 1 x 120	0,253	0,325	0,13	0,19	15,6
3 x 1 x 150	0,206	0,265	0,12	0,22	19,5
3 x 1 x 185	0,164	0,211	0,12	0,22	24,0
3 x 1 x 240	0,125	0,161	0,11	0,24	31,2

(*) Short circuit duration 0,5 seconds

C A B L E S F O R A M O V I N G W O R L D

TRATOS[®] ENERGY DNOs

Tratos Utility cables are designed and tested to meet relevant UK, European and International standards. Manufactured in state of the art manufacturing facilities, the company's purpose-built, in-house Fire, Chemical, Electrical and Physical testing facilities and laboratories deliver peace of mind to customers ensuring their choice of Utility cable products meet all statutory and regulatory requirements.



www.tratosgroup.com



RE4H1(AF)R cable

TRATOS RE4H1(AF)R-6/10 kV

Suitable for energy transmission between transformer rooms and big power users. For laying on air, into tube or open pass. Can be laid underground, also if not protected, complying with art. 4.3.11 of CEI 11-17 standard.

FEATURES AND PERFORMANCES

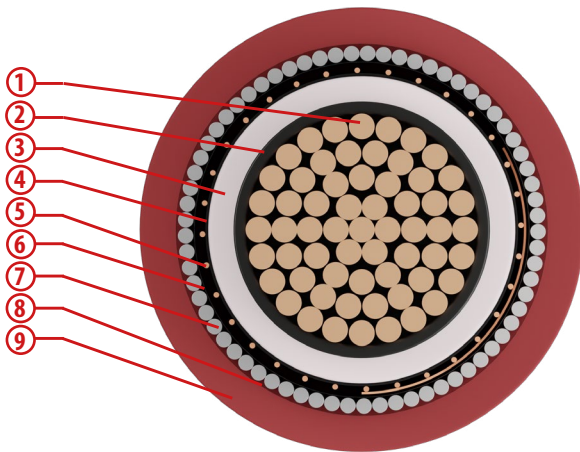

CONSTRUCTION

1. CLASS 2, COMPACT STRANDED WIRE, PLAIN COPPER
2. CROSS-LINKED POLYETHYLENE XLPE
3. INSULATION SCREEN: EXTRUDED SEMICONDUCTIVE LAYER, STRIPPABLE
4. PLAIN COPPER WIRES WITH COPPER TAPE
5. POLYESTER TAPE
6. THERMOPLASTIC FILLING COMPOUND
7. ALUMINIUM WIRES
8. POLYESTER TAPE
9. PVC, TYPE ST2 (UV RESISTANT, MOISTURE RESISTANT, ANTI-VERMIN AND ANTI-RODENT)

Structure and electrical, physical, mechanical requirements: CEI 20-13 IEC 60502

- **Measurement of partial discharges** CEI 20-16 IEC 60885-3
- **Fire propagation** EN 60332-1-2

Functional characteristics

Rated voltage U ₀ /U	6/10 kV
Maximum U voltage	12 kV
Max. operating temperature	90°C
Min. operating temperature	-15°C (without mechanical shocks)
Max. short circuit temperature	250°C

Installation conditions

Minimum installation temperature	0°C
Recommended min. bending radius	12 times the cable diameter
Recommended maximum tensile stress	60 N/mm ² of the cross-section of the copper

Technical characteristics

Formation	Approx. conductor \emptyset	Average insulation thickness	Approx. external \emptyset	Approx. cable weight	Current rating			
					in air		buried*	
					trefoil	flat	trefoil	flat
$n^\circ \times \text{mm}^2$	mm	mm	mm	kg/km				
1 x 150	14,3	3,4	36,0	2645	448	520	410	432
1 x 185	16,0	3,4	38,1	3090	516	600	464	490
1 x 240	18,3	3,4	40,6	3710	610	705	540	565
1 x 300	21,0	3,4	43,2	4410	703	810	605	635

* Ground thermal resistivity 100°C cm/W

Electrical characteristics

Formation	Max. electrical resistance at 20°C	Conductor apparent resistance at 90°C and 50Hz		Phase reactance		Capacity at 50Hz
		Ω/km		Ω/km		
$n^\circ \times \text{mm}^2$	Ω/km	trefoil	flat	trefoil	flat	$\mu\text{F}/\text{km}$
1 x 150	0,124	0,159	0,158	0,10	0,16	0,38
1 x 185	0,0991	0,128	0,127	0,10	0,16	0,42
1 x 240	0,0754	0,0985	0,0973	0,097	0,16	0,47
1 x 300	0,0601	0,0797	0,0780	0,095	0,15	0,52

U-1000 R2V cable

TRATOS U-1000 R2V

For use on industrial sites. Particularly suited in cases of high operating temperatures and when high resistance to UV radiation and atmospheric agents is required. Good resistance to low temperatures and chemical agents. Can be used without additional mechanical protection in the open air, fixed to walls or in channels, inside gangways or in empty spaces in constructions in general. Can be laid underground with mechanical protection constructed from slabs, tiles, or bricks. It is not recommend to lay this cable in ground flooded for more than two months per year. With appropriate mechanical protection, it can be used in areas subject to the risk of explosion, but in this case the permitted current load is reduced by 15%.

Reference Construction Products Regulation 305/2011 EU and Standard EN 50575:

The cable is suitable for the supply of electricity in buildings and other civil engineering works.

FEATURES AND PERFORMANCES

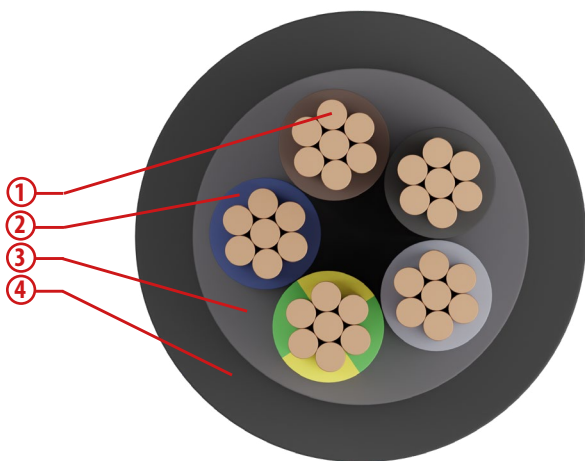

CONSTRUCTION

1. - CLASS 1, SOLID, PLAIN COPPER (CROSS-SECTION $\leq 4\text{MM}^2$)
- CLASS 2, STRANDED WIRE, PLAIN COPPER (CROSS-SECTION $\geq 6\text{MM}^2$)
2. XLPE (CROSS-LINKED POLYETHYLENE)
3. THERMOPLASTIC
4. PVC

Structure and electrical, physical, mechanical requirements: NF C 32-321

- Low Voltage Directive 2014/35/EU
- RoHS Directive 2011/65/EU

Special features

Excellent resistance to UV rays. (class AN3 according to NF C 15-100)

Cable Marking

Tratos NF-USE U-1000 R2V 337 [form.] 0,6/1 kV [year] LOT [traceability] [metric]

Tratos U-1000 R2V 337 [form.] 0,6/1 kV [year] LOT [traceability] [metric]

Colours

SINGLE-CORE



TWO-CORE



THREE-CORE



or for cross-section 1,5-2,5mm²



or for cross-section 1,5-2,5mm²



FOUR-CORE



or



SYMMETRIC VERSION



or



The cores in multiple cables for signal and control are black, numbered, with or without GREEN/YELLOW

Functional characteristics	
Rated voltage U ₀ /U	6/10 kV
Max. operating temperature	90°C
Min. operating temperature	-15°C (without mechanical shocks)
Max. short circuit temperature	250°C

Installation conditions	
Minimum installation temperature	-10°C
Recommended min. bending radius	6 times the cable diameter
Recommended maximum tensile stress	50 N/mm ² of the cross-section of the copper

U-1000 R2V - Single-core

Formation	Approx. conductor \emptyset	Average insulation thickness	Min. sheath thickness	Max. external \emptyset	Max. electrical resistance at 20°C	Approx. cable weight	Current rating A	
							n° x mm ²	mm
1 x 1,5	1,4	0,7	0,92	6,6	12,1	34	24	31
1 x 2,5	1,8	0,7	0,92	7,0	7,41	45	33	41
1 x 4	2,3	0,7	0,92	7,6	4,61	61	45	53
1 x 6	3,1	0,7	0,92	8,2	3,08	85	58	66
1 x 10	4,0	0,7	0,92	9,2	1,83	126	80	87
1 x 16	4,8	0,7	0,92	10,5	1,15	180	107	113
1 x 25	6,0	0,9	0,92	12,5	0,727	279	138	144
1 x 35	7,0	0,9	0,92	13,5	0,524	371	169	174
1 x 50	8,1	1,0	0,92	15,0	0,387	504	207	206
1 x 70	9,7	1,1	0,92	17,0	0,268	714	268	254
1 x 95	11,4	1,1	1,00	19,0	0,193	970	328	301
1 x 120	13,1	1,2	1,00	21,0	0,153	1218	382	343
1 x 150	14,6	1,4	1,08	23,0	0,124	1479	441	387
1 x 185	16,5	1,6	1,08	25,5	0,0991	1878	506	434
1 x 240	18,5	1,7	1,16	28,5	0,0754	2416	599	501
1 x 300	21,0	1,8	1,24	31,0	0,0601	3026	693	565
1 x 400 *	24,0	2,0	1,32	-	0,0470	3625	779	690
1 x 500 *	26,7	2,2	2,2	-	0,0366	5040	870	780
1 x 630 *	30,0	2,4	2,0	-	0,0283	6510	995	880

* Without NF USE mark

Permissible current rating values are according to:

- three conductors charged

- a buried cable with thermal resistivity of the ground equal to 1 K-m/W and laying depth of 600 mm

If conditions are different, apply correction factors of NF C 15-100 (tables 52G - 52N - 52O - 52P - 52Q - 52R - 52S - 52T).

U-1000 R2V - Two-core and three-core

Formation n° x mm ²	Approx. conductor Ø mm	Average insulation thickness mm	Min. sheath thickness mm	Max. external Ø mm	Max. electrical resistance at 20°C Ω/km	Approx. cable weight kg/km	Current rating A	
							free air at 30°C	buried at 20°C
2 x 1,5	1,4	0,7	1,24	10,5	12,1	92	26	37
2 x 2,5	1,6	0,7	1,24	11,5	7,41	128	36	48
2 x 4	2,3	0,7	1,24	13,0	4,61	167	49	63
2 x 6	3,1	0,7	1,24	14,0	3,08	236	63	80
2 x 10	4,0	0,7	1,24	16,0	1,83	342	86	104
2 x 16	4,8	0,7	1,24	18,5	1,15	490	115	136
2 x 25	6,0	0,9	1,24	22,0	0,727	761	149	173
2 x 35	7,0	0,9	1,24	24,5	0,524	999	185	208
2 x 50 *	8,1	1,0	1,24	27,5	0,387	1337	225	247
3 x 1,5	1,4	0,7	1,24	11,0	12,1	107	23	31
3 x 2,5	1,8	0,7	1,24	12,5	7,41	143	31	41
3 x 4	2,3	0,7	1,24	13,5	4,61	202	42	53
3 x 6	3,1	0,7	1,24	15,0	3,08	289	54	66
3 x 10	4,0	0,7	1,24	17,0	1,83	432	75	87
3 x 16	4,8	0,7	1,24	19,5	1,15	635	100	113
3 x 25	6,0	0,9	1,24	23,5	0,727	961	127	144
3 x 35	7,0	0,9	1,24	26,0	0,524	1279	158	174
3 x 50	8,1	1,0	1,24	29,0	0,387	1714	192	206
3 x 70	9,7	1,1	1,32	34,0	0,268	2436	246	254
3 x 95	11,4	1,1	1,40	38,5	0,193	3302	298	301
3 x 120	13,1	1,2	1,48	42,5	0,153	4181	346	343
3 x 150	14,6	1,4	1,64	47,5	0,124	5123	395	387
3 x 185	16,5	1,6	1,72	53,0	0,0991	6549	450	434
3 x 240	18,4	1,7	1,88	59,5	0,0754	8433	538	501
3 x 300	21,0	1,8	2,04	66,0	0,0601	10941	621	565

* without NF USE mark

Permissible current rating values are according to:

- two conductors charged for two-core cables
- three conductors charged for three-core cables
- a buried cable with thermal resistivity of the ground equal to 1 K-m/W and laying depth of 600 mm

If conditions are different, apply correction factors of NF C 15-100 (tables 52G - 52N - 52O - 52P - 52Q - 52R - 52S - 52T).

U-1000 R2V - Four-core and five-core

Formation	Approx. conductor \emptyset	Average insulation thickness	Min. sheath thickness	Max. external \emptyset	Max. electrical resistance at 20°C	Approx. cable weight	Current rating A	
							n° x mm ²	mm
4 x 1,5	1,4	0,7	1,24	12,0	12,1	127	23	31
4 x 2,5	1,8	0,7	1,24	13,0	7,41	174	31	41
4 x 4	2,3	0,7	1,24	14,5	4,61	247	42	53
4 x 6	3,1	0,7	1,24	16,0	3,08	358	54	66
4 x 10	4,0	0,7	1,24	18,5	1,83	539	75	87
4 x 16	4,8	0,7	1,24	21,0	1,15	794	100	113
4 x 25	6,0	0,9	1,24	25,5	0,727	1240	127	144
4 x 35	7,0	0,9	1,24	28,5	0,524	1642	158	174
4 x 50	8,1	1,0	1,32	32,5	0,387	2208	192	206
4 x 70	9,7	1,1	1,40	37,5	0,268	3112	246	254
4 x 95	11,4	1,1	1,48	42,5	0,193	4253	298	301
4 x 120	13,1	1,2	1,64	47,5	0,153	5371	346	343
4 x 150	14,6	1,4	1,72	52,5	0,124	6547	395	387
4 x 185	16,5	1,6	1,88	59,0	0,0991	8732	450	434
4 x 240	18,5	1,7	2,04	66,5	0,0754	10806	538	501
4 x 300	21,0	1,8	2,20	73,5	0,0601	14069	621	565
5 x 1,5	1,4	0,7	1,24	13,0	12,1	150	23	31
5 x 2,5	1,8	0,7	1,24	14,5	7,41	205	31	41
5 x 4	2,3	0,7	1,24	17,5	4,61	291	42	53
5 x 6	3,1	0,7	1,24	20,0	3,08	423	54	66
5 x 10	4,0	0,7	1,24	23,0	1,83	645	75	87
5 x 16	4,8	0,7	1,24	28,0	1,15	974	100	113
5 x 25	6,0	0,9	1,24	/	0,727	1519	127	144
5 x 35 *	7,0	0,9	1,24	/	0,524	2030	158	174
5 x 50 *	8,1	1,0	1,32	/	0,387	2760	192	206
5 x 70 *	9,7	1,1	1,40	/	0,268	3945	246	254

* Without NF USE mark

Permissible current rating values are according to:

- three conductors charged

- a buried cable with thermal resistivity of the ground equal to 1 K·m/W and laying depth of 600 mm

If conditions are different, apply correction factors of NF C 15-100 (tables 52G - 52N - 52O - 52P - 52Q - 52R - 52S - 52T).

U-1000 R2V - Four-core with reduced cross-section

Formation	Approx. conductor \emptyset	Average insulation thickness	Min. sheath thickness	Max. external \emptyset	Max. electrical resistance at 20°C	Approx. cable weight	Current rating A	
							free air at 30°C	buried at 20°C
n° x mm ²	mm	mm	mm	mm	Ω /km	kg/km		
3 x 35 + 25 *	7,0/6,0	0,9/0,9	1,24	-	0,524/0,727	1530	158	174
3 x 50 + 35	8,1/7,0	1,0/0,9	1,24	31,1	0,387/0,524	2051	192	206
3 x 70 + 50	9,7/8,1	1,1/1,0	1,40	36,2	0,268/0,387	2905	246	254
3 x 95 + 50	11,4/8,1	1,1/1,0	1,48	40,6	0,193/0,387	3769	298	301
3 x 120 + 70	13,1/9,7	1,2/1,1	1,56	45,4	0,153/0,268	4851	346	343
3 x 120 + 70	14,6/9,7	1,4/1,1	1,64	49,5	0,124/0,268	5625	395	387
3 x 185 + 70	16,5/9,7	1,6/1,1	1,80	54,4	0,0991/0,268	7228	450	434
3 x 240 + 95	18,5/11,4	1,7/1,1	1,96	61,5	0,0754/0,193	9359	538	501

* Without NF USE mark

Permissible current rating values are according to:

- three conductors charged

- a buried cable with thermal resistivity of the ground equal to 1 K-m/W and laying depth of 600 mm

If conditions are different, apply correction factors of NF C 15-100 (tables 52G - 52N - 52O - 52P - 52Q - 52R - 52S - 52T).

U-1000 R2V - Multi-core

Formation	Approx. conductor \emptyset	Average insulation thickness	Min. sheath thickness	Max. external \emptyset	Max. electrical resistance at 20°C	Approx. cable weight	Current rating A	
							free air at 30°C	buried at 20°C
n° x mm ²	mm	mm	mm	mm	Ω /km	kg/km		
7 x 1,5	1,4	0,7	1,24	13,5	12,1	194	15	22
8 x 1,5	1,4	0,7	1,24	14,5	12,1	220	14	20
10 x 1,5	1,4	0,7	1,24	16,5	12,1	268	13	18,5
12 x 1,5	1,4	0,7	1,24	17,0	12,1	305	12,5	18
14 x 1,5	1,4	0,7	1,24	18,0	12,1	346	12	17
19 x 1,5	1,4	0,7	1,24	19,5	12,1	441	10,5	15
24 x 1,5	1,4	0,7	1,24	22,5	12,1	552	10	14
30 x 1,5	1,4	0,7	1,24	24,0	12,1	643	9	12,5
37 x 1,5	1,4	0,7	1,24	25,5	12,1	793	8	12
7 x 2,5	1,8	0,7	1,24	15,0	7,41	272	20,5	28
8 x 2,5	1,8	0,7	1,24	16,5	7,41	304	19	27
10 x 2,5	1,8	0,7	1,24	19,0	7,41	380	18	24,5
12 x 2,5	1,8	0,7	1,24	19,5	7,41	435	17	24
14 x 2,5	1,8	0,7	1,24	20,5	7,41	494	16	22
19 x 2,5	1,8	0,7	1,24	22,5	7,41	642	14,5	19,5
24 x 2,5	1,8	0,7	1,24	25,5	7,41	805	13	18
30 x 2,5	1,8	0,7	1,24	27,5	7,41	883	12	16,5
37 x 2,5	1,8	0,7	1,24	29,5	7,41	1175	11	15,5

Permissible current rating values are according to:

- all conductors are charged (except for the green/yellow)

- a buried cable with thermal resistivity of the ground equal to 1 K-m/W and laying depth of 600 mm

If conditions are different, apply correction factors of NF C 15-100 (tables 52G - 52N - 52O - 52P - 52Q - 52R - 52S - 52T).

C A B L E S F O R A M O V I N G W O R L D

TRATOS[®] ENERGY DNOs

Tratos Utility cables are designed and tested to meet relevant UK, European and International standards. Manufactured in state of the art manufacturing facilities, the company's purpose-built, in-house Fire, Chemical, Electrical and Physical testing facilities and laboratories deliver peace of mind to customers ensuring their choice of Utility cable products meet all statutory and regulatory requirements.



www.tratosgroup.com



U-1000 AR2V cable

TRATOS U-1000 AR2V

For use on industrial sites. Particularly suited in cases of high operating temperatures and when high resistance to solar radiation and atmospheric agents is required. Good resistance to low temperatures and chemical agents. Can be used without additional mechanical protection in the open air, fixed to walls or in raceways, inside gangways or in empty spaces in constructions in general. Can be laid underground with mechanical protection constructed from slabs, tiles, or bricks. It is not recommend to lay this cable in ground flooded for more than two months per year. With appropriate mechanical protection, it can be used in areas subject to the risk of explosion, but in this case the permitted current load is reduced by 15%.

N.B. For applications not covered by Regulation EU 305/2011.

FEATURES AND PERFORMANCES

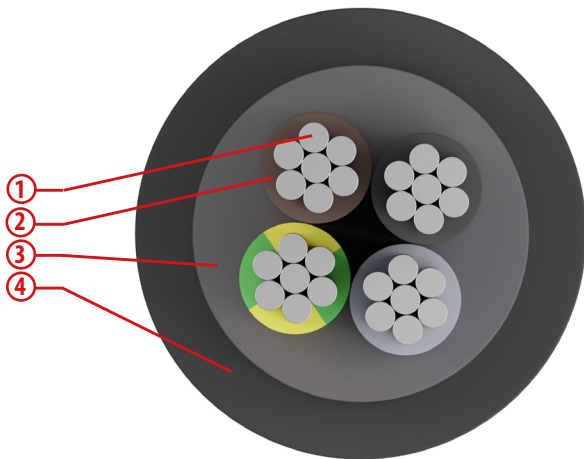

CONSTRUCTION

1. CLASS 2, STRANDED WIRE, ALUMINIUM
2. XLPE (CROSS-LINKED POLYETHYLENE)
3. THERMOPLASTIC
4. PVC

Structure and electrical, physical, mechanical requirements: NF C 32-321

- **Flame propagation** EN 60332-1-2
- **Low Voltage Directive** 2014/35/EU
- **RoHS Directive** 2011/65/EU

Cable Marking

Tratos NF-USE U-1000 AR2V 337 [form.] 0,6/1 kV [year] LOT [traceability] [metric]

Colours

SINGLE-CORE



TWO-CORE



THREE-CORE



FOUR-CORE

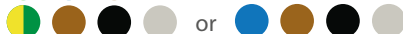

SYMMETRIC VERSION

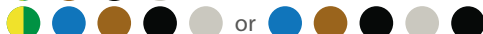

The cores in multiple cables for signal and control are black, numbered, with or without GREEN/YELLOW

Functional characteristics

Rated voltage U ₀ /U	0,6/1 kV
Max. operating temperature	90°C
Min. operating temperature	-15°C (without mechanical shocks)
Max. short circuit temperature	250°C

Installation conditions

Minimum installation temperature	-10°C
Recommended min. bending radius	8 times the cable diameter
Recommended maximum tensile stress	50 N/mm ² of the cross-section of the copper

U-1000 AR2V - Single-core

Formation	Approx. conductor \emptyset	Average insulation thickness	Min. sheath thickness	Max. external \emptyset	Max. electrical resistance at 20°C	Approx. cable weight	Current rating A	
							free air at 30°C	buried at 20°C
n° x mm ²	mm	mm	mm	mm	Ω /km	kg/km		
1 x 10	4,1	0,7	1,09	9,2	3,08	85	62	67
1 x 16	4,9	0,7	1,09	10,5	1,91	115	84	87
1 x 25	6,1	0,9	1,09	12,5	1,20	150	101	111
1 x 35	7,1	0,9	1,09	13,5	0,868	185	126	134
1 x 50	8,2	1,0	1,09	15,0	0,641	230	126	160
1 x 70	9,9	1,1	1,09	17,0	0,443	310	198	197
1 x 95	11,4	1,1	1,18	19,0	0,320	400	241	234
1 x 120	13,1	1,2	1,18	21,0	0,253	505	280	266
1 x 150	14,4	1,4	1,26	23,0	0,206	620	324	300
1 x 185	16,2	1,6	1,26	25,5	0,164	770	371	337
1 x 240	18,4	1,7	1,35	28,5	0,125	980	439	388
1 x 300	20,7	1,8	1,43	31,0	0,100	1195	508	440

Permissible current rating values are according to:

- three conductors charged

- a buried cable with thermal resistivity of the ground equal to 1 K-m/W and laying depth of 600 mm

If conditions are different, apply correction factors of NF C 15-100 (tables 52G - 52N - 52O - 52P - 52Q - 52R - 52S - 52T).

U-1000 AR2V - Two-core and three-core

Formation	Approx. conductor \emptyset	Average insulation thickness	Min. sheath thickness	Max. external \emptyset	Max. electrical resistance at 20°C	Approx. cable weight	Current rating A	
							free air at 30°C	buried at 20°C
n° x mm ²	mm	mm	mm	mm	Ω /km	kg/km		
2 x 10	4,1	0,7	1,43	16,0	3,08	290	62	67
2 x 16	4,9	0,7	1,43	18,5	1,91	330	84	104
2 x 25	6,1	0,9	1,43	22,0	1,20	520	101	133
2 x 35	7,1	0,9	1,43	24,5	0,868	650	126	160
3 x 16	4,9	0,7	1,43	19,5	1,91	405	126	87
3 x 25	6,1	0,9	1,43	23,5	1,20	590	198	111
3 x 35	7,1	0,9	1,43	26,0	0,868	725	241	134
3 x 50	8,2	1,0	1,43	29,0	0,641	930	280	160
3 x 70	9,9	1,1	1,52	34,0	0,443	1290	324	197
3 x 95	11,4	1,1	1,60	38,5	0,320	1650	371	234
3 x 120	13,1	1,2	1,69	42,5	0,253	2030	439	266
3 x 150	14,4	1,4	1,86	47,5	0,206	2510	508	300
3 x 185	16,2	1,6	1,94	53,0	0,164	3220		337
3 x 240	18,4	1,7	2,11	59,5	0,125	4990		388
3 x 300	20,7	1,8	2,28	66,0	0,100	6650		440

Permissible current rating values are according to:

- two conductors charged for two-core cables

- three conductors charged for three-core cables

- a buried cable with thermal resistivity of the ground equal to 1 K-m/W and laying depth of 600 mm

If conditions are different, apply correction factors of NF C 15-100 (tables 52G - 52N - 52O - 52P - 52Q - 52R - 52S - 52T).

U-1000 AR2V - Four-core with reduced cross-section

Formation n° x mm ²	Approx. conductor Ø mm	Average insulation thickness mm	Min. sheath thickness mm	Max. external Ø mm	Max. electrical resistance at 20°C Ω/km	Approx. cable weight kg/km	Current rating A	
							free air at 30°C	buried at 20°C
3 x 50 + 35	8,2/7,1	1,0/0,9	1,43	31,1	0,641/0,868	1040	146	160
3 x 70 + 50	9,9/8,2	1,1/1,0	1,60	36,2	0,443/0,641	1450	187	197
3 x 95 + 50	11,4/8,2	1,1/1,0	1,69	40,6	0,320/0,641	1780	227	234
3 x 120 + 70	13,1/9,9	1,2/1,1	1,77	45,4	0,253/0,443	2305	263	266
3 x 120 + 70	14,6/9,9	1,4/1,1	1,86	49,5	0,206/0,443	2305	304	300
3 x 185 + 70	16,2/9,9	1,6/1,1	2,03	54,4	0,164/0,443	3240	347	337
3 x 240 + 95	18,4/11,4	1,7/1,1	2,20	61,5	0,125/0,320	3240	409	388

* Without NF USE mark

Permissible current rating values are according to:

- three conductors charged

- a buried cable with thermal resistivity of the ground equal to 1 K-m/W and laying depth of 600 mm

If conditions are different, apply correction factors of NF C 15-100 (tables 52G - 52N - 52O - 52P - 52Q - 52R - 52S - 52T).

U-1000 AR2V - Four-core and five-core

Formation n° x mm ²	Approx. conductor Ø mm	Average insulation thickness mm	Min. sheath thickness mm	Max. external Ø mm	Max. electrical resistance at 20°C Ω/km	Approx. cable weight kg/km	Current rating A	
							free air at 30°C	buried at 20°C
4 x 10	4,1	0,7	1,43	18,5	3,08	370	58	67
4 x 16	4,9	0,7	1,43	21,0	1,91	480	77	87
4 x 25	6,1	0,9	1,43	25,5	1,20	710	97	111
4 x 35	7,1	0,9	1,43	28,5	0,868	880	120	134
4 x 50	8,2	1,0	1,52	32,5	0,641	1115	146	160
4 x 70	9,9	1,1	1,60	37,5	0,443	1560	187	197
4 x 95	11,4	1,1	1,69	42,5	0,320	1985	227	234
4 x 120	13,1	1,2	1,86	47,5	0,253	2410	263	266
4 x 150	14,4	1,4	1,94	52,5	0,206	3010	304	300
4 x 185	16,2	1,6	2,11	59,0	0,164	3930	347	337
4 x 240	18,4	1,7	2,45	66,5	0,125	4900	409	388
4 x 300	20,7	1,8	1,43	73,5	0,100	6120	471	440
5 x 16	4,9	0,7	1,43	23,0	1,91	580	77	87
5 x 25	6,1	0,9	1,43	28,0	1,20	845	97	111

Permissible current rating values are according to:

- all conductors are charged (except for the green/yellow)

- a buried cable with thermal resistivity of the ground equal to 1 K-m/W and laying depth of 600 mm

If conditions are different, apply correction factors of NF C 15-100 (tables 52G - 52N - 52O - 52P - 52Q - 52R - 52S - 52T).

C A B L E S F O R A M O V I N G W O R L D

TRATOS[®] ENERGY DNOs

Tratos Utility cables are designed and tested to meet relevant UK, European and International standards. Manufactured in state of the art manufacturing facilities, the company's purpose-built, in-house Fire, Chemical, Electrical and Physical testing facilities and laboratories deliver peace of mind to customers ensuring their choice of Utility cable products meet all statutory and regulatory requirements.



www.tratosgroup.com



TRATOS General Cables®

FR-N1X1G1-U/R cable

TRATOS FR-N1X1G1-U/R

This cable is recommended for use in public and industrial settings whenever good fire retardant qualities, reduced fumes, toxic and corrosive gases emissions are required in the case of fire. For use in industrial settings, in the upright columns of buildings when strict safety standards have to be respected. It offers good resistance to low temperatures, chemical agents, solar radiation, and mechanical forces in general. Can be used for static applications in the open air, in pipes, or in cable trenches. The cable can be laid directly in the ground for short periods on the condition that the ground is not flooded and that it is provided with suitable mechanical protection. With appropriate mechanical protection, it can be used in areas subject to the risk of explosion, but in this case the permitted current load is reduced by 15%.

Reference Construction Products Regulation 305/2011 EU and Standard EN 50575:

Given its properties of limiting the development of fire, heat emission and noxious fumes, the cable is suitable for the supply of electricity in buildings and other civil engineering works.

FEATURES AND PERFORMANCES

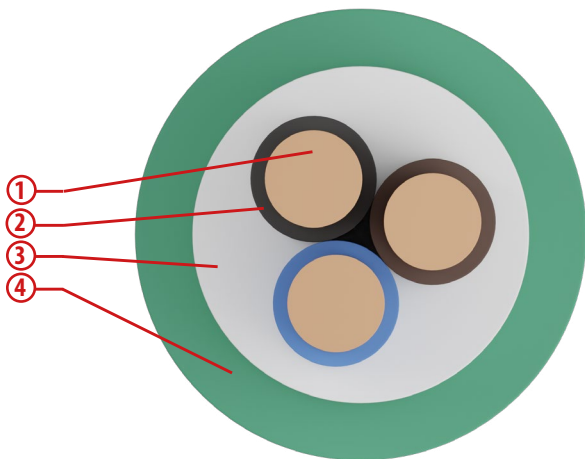

CONSTRUCTION

1. CLASS 1, SOLID, PLAIN COPPER (CROSS-SECTION $\leq 4\text{MM}^2$)
CLASS 2, STRANDED WIRE, PLAIN COPPER (CROSS-SECTION $\geq 6\text{MM}^2$)
2. XLPE (CROSS-LINKED POLYETHYLENE)
3. LSOH THERMOPLASTIC
4. LSOH POLYOLEFIN

LSOH = Low Smoke Zero Halogen

Structure and electrical, physical, mechanical requirements: NF C 32-323 NF C 32-323/A1

• Fire propagation	EN 60332-3-24 NF C 32-070 C1 IEC 60332-3-24 C
• Corrosive gases or halogens	EN 50267-2-1 EN 50267-2-2
• Smoke density (transmittance)	EN 61034-2
• Low Voltage Directive	2014/35/EU
• RoHS Directive	2011/65/EU

Cable Marking

Tratos NF-USE 337 FR-N1X1G1-U/R 0,6/1 kV Cca-s1,d1,a1 [form.] NF C 32-323 [year] [traceability] [metric]

Colours

SINGLE-CORE	●								
TWO-CORE	● ●								
THREE-CORE	● ● ●								
FOUR-CORE	● ● ● ●								
FIVE-CORE	● ● ● ● ●								

or for cross-section 1,5-2,5mm² ● ● ● ● ● or for cross-section $\geq 4\text{mm}^2$ ● ● ● ● ●

The cores in multiple cables for signal and control are black, numbered, with or without GREEN/YELLOW

Functional characteristics	
Rated voltage U ₀ /U	0,6/1 kV
Max. operating temperature	90°C
Min. operating temperature	-15°C (without mechanical shocks)
Max. short circuit temperature	250°C

Installation conditions	
Minimum installation temperature	0°C
Recommended min. bending radius	12 times the cable diameter
Recommended maximum tensile stress	50 N/mm ² of the cross-section of the copper

FR-N1X1G1 - Single-core

Formation	Approx. conductor Ø	Average insulation thickness	Average sheath thickness	Max. external Ø	Max. electrical resistance at 20°C	Approx. cable weight	Current rating A		
							n° x mm ²	mm	mm
1 x 35	7,0	0,9	1,09	13,5	0,524	430		169	174
1 x 50	8,1	1,0	1,09	15,0	0,387	555		207	206
1 x 70	9,7	1,1	1,09	17,0	0,268	765		268	254
1 x 95	11,4	1,1	1,18	19,0	0,193	1015		328	301
1 x 120	13,1	1,2	1,18	21,0	0,153	1375		382	343
1 x 150	14,6	1,4	1,26	23,0	0,124	1630		441	387
1 x 185	16,5	1,6	1,26	25,5	0,0991	2035		506	434
1 x 240	18,5	1,7	1,35	28,5	0,0754	2575		599	501
1 x 300	21,0	1,8	1,43	31,0	0,0601	3170		693	565

Permissible current rating values are according to:

- three conductors charged for single-core cables buried with thermal resistivity of the ground equal to 1 K-m/W and laying depth of 600 mm
- two conductors charged for two-core cables, three conductors charged for three-core cables buried with thermal resistivity of the ground equal to 1 K-m/W and laying depth of 600 mm

If conditions are different, apply correction factors of NF C 15-100 (tables 52G - 52N - 52O - 52P - 52Q - 52R - 52S - 52T).

FR-N1X1G1 - Two-core and three-core

Formation n° x mm ²	Approx. conductor Ø mm	Average insulation thickness mm	Average sheath thickness mm	Max. external Ø mm	Max. electrical resistance at 20°C Ω/km	Approx. cable weight kg/km	Current rating A	
							free air at 30°C	buried at 20°C
2 x 1,5	1,4	0,7	1,43	10,5	12,1	125	26	37
2 x 2,5	1,8	0,7	1,43	11,5	7,41	155	36	48
2 x 4	2,3	0,7	1,43	13,0	4,61	200	49	63
2 x 6	3,1	0,7	1,43	14,0	3,08	275	63	80
2 x 10	4,0	0,7	1,43	16,0	1,83	385	86	104
2 x 16	4,8	0,7	1,43	18,5	1,15	600	115	136
2 x 25	6,0	0,9	1,43	22,0	0,727	880	149	173
2 x 35	7,0	0,9	1,43	24,5	0,524	1150	185	208
3 x 1,5	1,4	0,7	1,43	11,0	12,1	140	23	31
3 x 2,5	1,8	0,7	1,43	12,5	7,41	180	31	41
3 x 4	2,3	0,7	1,43	13,5	4,61	235	42	53
3 x 6	3,1	0,7	1,43	15,0	3,08	350	54	66
3 x 10	4,0	0,7	1,43	17,0	1,83	470	75	87
3 x 16	4,8	0,7	1,43	19,5	1,15	740	100	113
3 x 25	6,0	0,9	1,43	23,5	0,727	1090	127	144
3 x 35	7,0	0,9	1,43	26,0	0,524	1445	158	174
3 x 50	8,1	1,0	1,43	29,0	0,387	1890	192	206
3 x 70	9,7	1,1	1,52	34,0	0,268	2655	246	254

Permissible current rating values are according to:

- three conductors charged for single-core cables buried with thermal resistivity of the ground equal to 1 K·m/W and laying depth of 600 mm

- two conductors charged for two-core cables, three conductors charged for three-core cables buried with thermal resistivity of the ground equal to 1 K·m/W and laying depth of 600 mm

If conditions are different, apply correction factors of NF C 15-100 (tables 52G - 52N - 52O - 52P - 52Q - 52R - 52S - 52T).

FR-N1X1G1 - Four-core and five-core

Formation	Approx. conductor \emptyset	Average insulation thickness	Average sheath thickness	Max. external \emptyset	Max. electrical resistance at 20°C	Approx. cable weight	Current rating A	
							n° x mm ²	mm
4 x 1,5	1,4	0,7	1,43	12,0	12,1	165	23	31
4 x 2,5	1,8	0,7	1,43	13,0	7,41	215	31	41
4 x 4	2,3	0,7	1,43	14,5	4,61	285	42	53
4 x 6	3,1	0,7	1,43	16,0	3,08	395	54	66
4 x 10	4,0	0,7	1,43	18,5	1,83	580	75	87
4 x 16	4,8	0,7	1,43	21,0	1,15	905	100	113
4 x 25	6,0	0,9	1,43	25,5	0,727	1365	127	144
4 x 35	7,0	0,9	1,43	28,5	0,524	1845	158	174
4 x 50	8,1	1,0	1,52	32,5	0,387	2390	192	206
4 x 70	9,7	1,1	1,60	37,5	0,268	3325	246	254
4 x 95	11,4	1,1	1,69	42,5	0,193	4460	298	301
5 x 1,5	1,4	0,7	1,43	13,0	12,1	200	23	31
5 x 2,5	1,8	0,7	1,43	14,5	7,41	260	31	41
5 x 4	2,3	0,7	1,43	16,0	4,61	330	42	53
5 x 6	3,1	0,7	1,43	17,5	3,08	456	54	66
5 x 10	4,0	0,7	1,43	20,0	1,83	690	75	87
5 x 16	4,8	0,7	1,43	23,0	1,15	1100	100	113
5 x 25	4,8	0,7	1,43	28,0	0,727	1650	127	144

Permissible current rating values are according to:

- three conductors charged

- a buried cable with thermal resistivity of the ground equal to 1 K-m/W and laying depth of 600 mm

If conditions are different, apply correction factors of NF C 15-100 (tables 52G - 52N - 52O - 52P - 52Q - 52R - 52S - 52T)

FR-N1X1G1 - Multi-core

Formation	Approx. conductor \emptyset	Average insulation thickness	Average sheath thickness	Max. external \emptyset	Max. electrical resistance at 20°C	Approx. cable weight	Current rating A	
							n° x mm ²	mm
7 x 1,5	1,4	0,7	1,43	13,5	12,1	290	15	22
12 x 1,5	1,4	0,7	1,43	17,0	12,1	430	12,5	18
19 x 1,5	1,4	0,7	1,43	19,5	12,1	580	10,5	15

Permissible current rating values are according to:

- a single-phase circuit and all cores loaded

- a buried cable with thermal resistivity of the ground equal to 1 K-m/W and laying depth of 600 mm

If conditions are different, apply correction factors of NF C 15-100 (tables 52G - 52N - 52O - 52P - 52Q - 52R - 52S - 52T).

SYT+DIGITAL cable

TRATOS SYT+DIGITAL

For the connection of indoor telephone systems and digital data transmission lines (Internet, ADSL etc.) up to 2 Mbit/s. The screen acts as protection against electromagnetic interference.

Reference Construction Products Regulation 305/2011 EU and Standard EN 50575:

The cable is suitable for the supply of electricity in buildings and other civil engineering works.

FEATURES AND PERFORMANCES

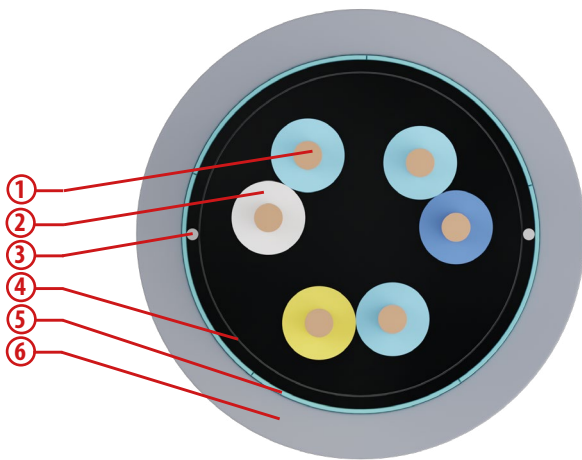

CONSTRUCTION

1. CLASS 1, SOLID, PLAIN COPPER
2. POLYETHYLENE
3. CABLING: SUB UNIT EACH 7 OR 14 PAIRS FOR CABLES HAVING 21 OR MORE PAIRS, CONCENTRIC LAYERS FOR CABLES HAVING LESS THAN 20 PAIRS LSOH POLYOLEFIN
4. POLYESTER FOIL
5. ALUMINIUM/POLYESTER FOIL AND TINNED COPPER DRAIN-WIRE
6. PVC

Structure and electrical, physical, mechanical requirements: UTE C 93-529-2

- Low Voltage Directive 2014/35/EU
- RoHS Directive 2011/65/EU

Cable Marking

Tratos SYT PLUS 1 NUM ww/yy [form.] [traceability]

Installation conditions

Minimum installation temperature	0°C
Recommended min. bending radius	16 times the cable diameter
Recommended maximum tensile stress	50 N/mm ² of the cross-section of the copper

Functional characteristics

Electrical resistance at 20°C (loop)	- AWG24 ≤ 192Ω /km - AWG20 ≤ 75 Ω/km
Insulation resistance at 20°C	min. 1500 M Ω·km
Mutual capacity (800 Hz)	max. 80 nF/km
Capacity unbalance (800 Hz)	max. 300 pF/500 m
Characteristic impedance (1 MHz)	100±20 Ω

Typical attenuation dB/100 m		
	AWG 24	AWG 20
(40 kHz)	0,65	0,30
(150 kHz)	0,85	0,65
(300 kHz)	1,30	1,30
(1 kHz)	3,00	2,50
(2 kHz)	4,20	3,50

Min. near-end crosstalk NEXT	
	AWG 24-AWG 20
(40 kHz)	0,65
(150 kHz)	0,85
(300 kHz)	1,30
(1 kHz)	3,00
(2 kHz)	4,20

AWG 24

Pairs n°	Approx. conductor Ø mm	Min. insulation thickness mm	Average sheath thickness mm	Approx. external Ø mm	Approx. cable weight kg/km
1	0,51	0,10	0,6	3,8	18
2	0,51	0,10	0,6	4,7	24
3	0,51	0,10	0,6	5,2	29
5	0,51	0,10	0,6	5,8	39
7	0,51	0,10	0,8	7,1	59
10	0,51	0,10	0,8	7,8	74
15	0,51	0,10	0,8	8,7	99
21	0,51	0,10	0,9	10,4	135
30	0,51	0,10	0,9	11,6	180
42	0,51	0,10	0,9	13,0	255
56	0,51	0,10	1,0	15,2	310
112	0,51	0,10	1,0	20,6	590

AWG 20

Pairs n°	Approx. conductor Ø mm	Min. insulation thickness mm	Average sheath thickness mm	Approx. external Ø mm	Approx. cable weight kg/km
1	0,81	0,15	0,6	5,0	32
2	0,81	0,15	0,8	4,7	43
3	0,81	0,15	0,8	5,2	56
5	0,81	0,15	0,8	5,8	81
7	0,81	0,15	0,9	7,1	115
10	0,81	0,15	0,9	7,8	145
15	0,81	0,15	0,9	8,7	215
21	0,81	0,15	1,0	10,4	295
30	0,81	0,15	1,0	11,6	395
42	0,81	0,15	1,0	13,0	545
56	0,81	0,15	1,0	15,2	705
112	0,81	0,15	1,0	20,6	1305

SYS cable

TRATOS SYS

For the connection of indoor telephone systems and digital data transmission lines (Internet, ADSL etc.) up to 2 Mbit/s.

N.B. For applications not covered by Regulation EU 305/2011.

FEATURES AND PERFORMANCES

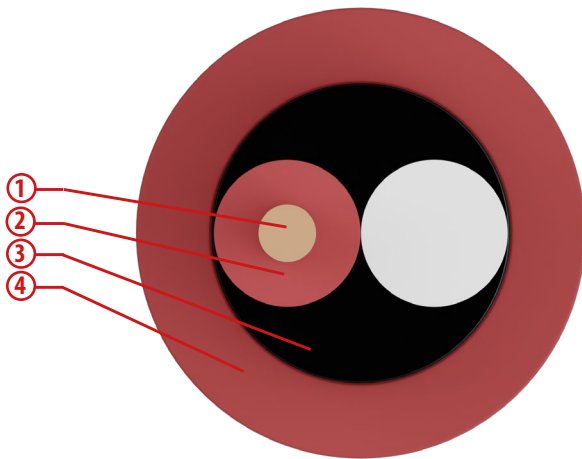

CONSTRUCTION

1. CLASS 1, SOLID, PLAIN COPPER
2. POLYETHYLENE
3. POLYESTER FOIL
4. PVC

Structure and electrical, physical, mechanical requirements: UTE C 93-529-2

- **Flame propagation** IEC 60332-1
- **Low Voltage Directive** 2014/35/EU
- **RoHS Directive** 2011/65/EU

Cable Marking

Tratos SYS [traceability] [year]

Installation conditions

Minimum installation temperature	0°C
Recommended min. bending radius	10 times the cable diameter
Recommended maximum tensile stress	50 N/mm ² of the cross-section of the copper

Functional characteristics

Rated voltage U ₀ /U	300 V
Insulation resistance at 20°C	min. 500 M Ω·km
Mutual capacity (800 Hz)	max. 70 nF/km
Characteristic impedance (1 MHz)	100±20 Ω
Attenuation (2 MHz)	max. 3,5 dB/100 m
Near-end crosstalk NEXT (2 MHz)	min. 41 dB

Formation n° x mm ²	Approx. conductor ∅ mm	Average insulation thickness mm	Average sheath thickness mm	Max. external ∅ mm	Max. electrical resistance at 20°C Ω/km	Approx. cable weight kg/km
1P0,8 (1x2xAWG20)	0,81	0,3	0,8	4,3	37,0	25

CABLES FOR A MOVING WORLD

TRATOS[®] ENERGY DNOs

Tratos Utility cables are designed and tested to meet relevant UK, European and International standards. Manufactured in state of the art manufacturing facilities, the company's purpose-built, in-house Fire, Chemical, Electrical and Physical testing facilities and laboratories deliver peace of mind to customers ensuring their choice of Utility cable products meet all statutory and regulatory requirements.



www.tratosgroup.com



NYM-J cable

TRATOS NYM-J

For use in industrial electrical systems. Can be laid outdoor in humid, dry or rainy environments, and indoor in brickwork and concrete structures. It is not permitted under compressed, solidified reinforced concrete. Outdoor use is only permitted with protection from solar radiation. It must not be laid underground.

Reference Construction Products Regulation 305/2011 EU and Standard EN 50575:

The cable is suitable for the supply of electricity in buildings and other civil engineering works.

FEATURES AND PERFORMANCES

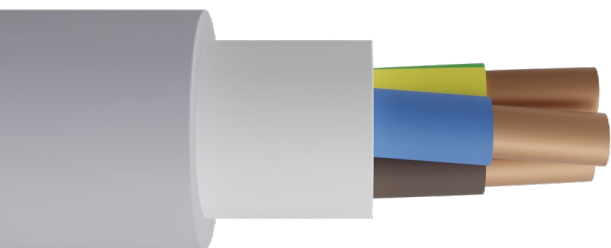
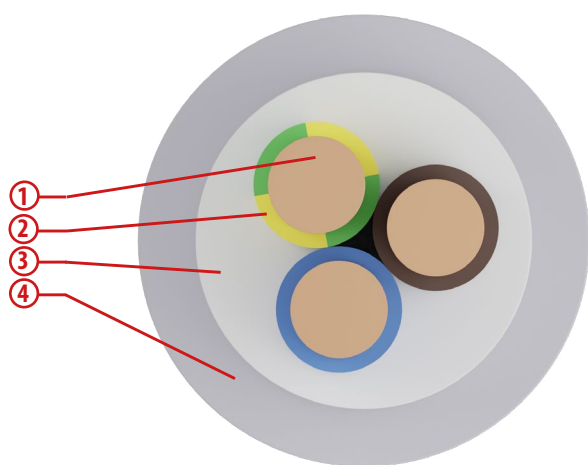

CONSTRUCTION

1. CLASS 1, SOLID, PLAIN COPPER (CROSS-SECTION $\leq 10 \text{ MM}^2$)
CLASS 2, STRANDED WIRE, PLAIN COPPER (CROSS-SECTION $\geq 16 \text{ MM}^2$)
2. PVC
3. THERMOPLASTIC
4. PVC

Structure and electrical, physical, mechanical requirements: VDE 0250 Part 204

- **Low Voltage Directive** 2014/35/EU
- **RoHS Directive** 2011/65/EU

Installation conditions

Minimum installation temperature	5°C
Recommended min. bending radius	6 times the cable diameter
Recommended maximum tensile stress	50 N/mm ² of the cross-section of the copper

Functional characteristics

Rated voltage U ₀ /U	300/500 V
Max. operating temperature	70°C
Min. operating temperature	-10°C (without mechanical shocks)
Max. short circuit temperature	160°C

Colours

- SINGLE-CORE 
- THREE-CORE 
- FOUR-CORE 
- FIVE-CORE 

The cores in multiple cables for signal and control are black, numbered, with or without GREEN/YELLOW

Single-core NYM-J with conductor green/yellow

Formation	Approx. conductor \emptyset	Average insulation thickness	Average sheath thickness	Max. external \emptyset	Max. electrical resistance at 20°C	Approx. cable weight	Current rating A	
							free air at 30°C	buried at 20°C
n° x mm ²	mm	mm	mm	mm	Ω /km	kg/km		
1 x 1,5	1,4	0,6	1,4	6,2	12,1	44	17,5	15,5
1 x 2,5	1,8	0,7	1,4	7,0	7,41	60	24	21
1 x 4	2,3	0,8	1,4	7,7	4,61	78	32	28
1 x 6	2,8	0,8	1,4	8,2	3,08	100	41	36
1 x 10	3,5	1,0	1,4	9,6	1,83	150	57	50
1 x 16	4,8	1,0	1,4	11,0	1,15	220	76	68

Permissible current rating values are according to:
- three-phase circuit

Multi-core NYM-J with conductor green/yellow

Formation	Approx. conductor \emptyset	Average insulation thickness	Average sheath thickness	Max. external \emptyset	Max. electrical resistance at 20°C	Approx. cable weight	Current rating A	
							free air at 30°C	buried at 20°C
n° x mm ²	mm	mm	mm	mm	Ω /km	kg/km		
3 x 1,5	1,4	0,6	1,4	9,9	12,1	120	17,5	15
3 x 2,5	1,8	0,7	1,4	11,4	7,41	165	24	20
3 x 4	2,3	0,8	1,4	13,0	4,61	235	32	27
3 x 6	2,8	0,8	1,6	14,7	3,08	320	41	34
3 x 10	3,5	1,0	1,6	17,7	1,83	500	57	46
3 x 16	4,8	1,0	1,6	21,0	1,15	735	76	62
4 x 1,5	1,4	0,6	1,4	10,7	12,1	150	17,5	15
4 x 2,5	1,8	0,7	1,4	12,3	7,41	205	24	20
4 x 4	2,3	0,8	1,6	14,6	4,61	295	32	27
4 x 6	2,8	0,8	1,6	16,1	3,08	390	41	34
4 x 10	3,5	1,0	1,6	19,5	1,83	620	57	46
4 x 16	4,8	1,0	1,6	23,0	1,15	910	76	62
4 x 25	6,0	1,2	1,8	28,3	0,727	1430	96	80
4 x 35	7,0	1,2	1,8	31,1	0,524	1860	119	99
5 x 1,5	1,4	0,6	1,4	11,5	12,1	165	17,5	15
5 x 2,5	1,8	0,7	1,4	13,3	7,41	240	24	20
5 x 4	2,3	0,8	1,6	16,0	4,61	360	32	27
5 x 6	2,8	0,8	1,6	17,5	3,08	475	41	34
5 x 10	3,5	1,0	1,6	21,3	1,83	750	57	46
5 x 16	4,8	1,0	1,8	25,6	1,15	1135	76	62
5 x 25	6,0	1,2	1,8	31,1	0,727	1735	96	80
5 x 35	7,0	1,2	1,8	34,3	0,524	2285	119	99
7 x 1,5	1,4	0,6	1,4	12,6	12,1	220	12	10,5
7 x 2,5	1,8	0,7	1,6	15,2	7,41	330	17	14

Permissible current rating values are according to:
- two-phase circuit for two-core cables
- three-phase circuit for three-core, four-core, five-core and multi-core cables

TRATOS General Cables®

NHXMH-J | NHXMH-O cable

TRATOS NHXMH-J TRATOS NHXMH-O

For use electrical circuits located in fire risk areas and with large number of people, including industrial plants, hotel, airports, underground stations, train stations and department stores. Can be used in uncomfortable climatic conditions, subject to rain and fog, and laid on or under plaster and brickwork structures. Not be used for direct installation under reinforced, vibrated or compressed concrete. It must not be laid underground.

Reference Construction Products Regulation 305/2011 EU and Standard EN 50575:

Given its properties of limiting the development of fire, heat emission and noxious fumes, the cable is suitable for the supply of electricity in buildings and other civil engineering works.

FEATURES AND PERFORMANCES

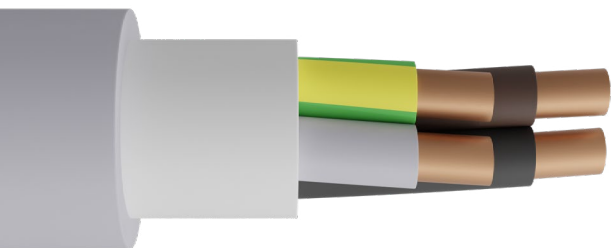
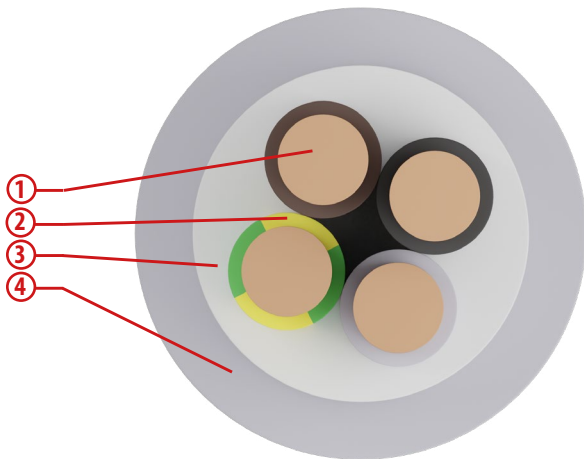

CONSTRUCTION

1. CLASS 1, SOLID, PLAIN COPPER (CROSS-SECTION $\leq 10 \text{ MM}^2$)
CLASS 2, STRANDED WIRE, PLAIN COPPER (CROSS-SECTION $\geq 16 \text{ MM}^2$)
2. XLPE (CROSS-LINKED POLYETHYLENE)
3. LSOH THERMOPLASTIC
4. LSOH POLYOLEFIN

LSOH = Low Smoke Zero Halogen

Structure and electrical, physical, mechanical requirements: VDE 0250 Part 214

• Fire propagation	EN 60332-3-24
• Corrosive gases or halogens	EN 50267-2-2
• Smoke density (transmittance)	EN 61034-2
• Low Voltage Directive	2014/35/EU
• RoHS Directive	2011/65/EU

Installation conditions	
Minimum installation temperature	-5°C
Recommended min. bending radius	15 times the cable diameter for single-core cables, 10 times the cable diameter for multi-core cables
Recommended maximum tensile stress	50 N/mm ² of the cross-section of the copper

Functional characteristics	
Rated voltage U ₀ /U	300/500 V
Max. operating temperature	70°C
Min. operating temperature	-20°C (without mechanical shocks)
Max. short circuit temperature	250°C

Marking

Tratos <VDE> [company] NHXMH-J Cca-s1,d2,a1 [form.] [year] [traceability]

Colours

TWO-CORE	● ●
THREE-CORE	● ● ● or ● ● ●
FOUR-CORE	● ● ● ● or ● ● ● ●
FIVE-CORE	● ● ● ● ● or ● ● ● ● ●

Multi-core
 NHXMH-J with conductor green/yellow
 NHXMH-O without conductor green/yellow

Formation	Approx. conductor Ø	Average insulation thickness	Average sheath thickness	Max. external Ø	Max. electrical resistance at 20°C	Approx. cable weight
n° x mm ²	mm	mm	mm	mm	Ω/km	kg/km
2 x 1,5	1,4	0,5	1,4	9,2	12,1	110
2 x 2,5	1,8	0,5	1,4	10,1	7,41	150
2 x 4	2,2	0,6	1,4	11,6	4,61	200
3 x 1,5	1,4	0,5	1,4	9,6	12,1	130
3 x 2,5	1,8	0,5	1,4	10,6	7,41	170
3 x 4	2,2	0,6	1,4	12,2	4,61	235
3 x 6	2,7	0,6	1,6	13,9	3,08	320
3 x 10	3,6	0,7	1,6	16,7	1,83	485
4 x 1,5	1,4	0,5	1,4	10,3	12,1	155
4 x 2,5	1,8	0,5	1,4	11,5	7,41	205
4 x 4	2,2	0,6	1,6	13,7	4,61	300
4 x 6	2,7	0,6	1,6	15,3	3,08	395
4 x 10	3,6	0,7	1,6	18,2	1,83	605
4 x 16	4,7	0,7	1,6	21,8	1,15	855
5 x 1,5	1,4	0,5	1,4	11,0	12,1	180
5 x 2,5	1,8	0,5	1,4	12,3	7,41	240
5 x 4	2,2	0,6	1,6	15,1	4,61	355
5 x 6	2,7	0,6	1,6	16,6	3,08	470
5 x 10	3,6	0,7	1,6	19,7	1,83	745
5 x 16	4,7	0,7	1,8	23,8	1,15	1120

TRATOS General Cables®

YSLY-JZ | YSLY-OZ cable

TRATOS YSLY-JZ-300/500 V TRATOS YSLY-OZ-300/500 V

For use in dry, humid or wet environments subject to moderate mechanical loads. Can be used outdoor only if protected from UV radiation and within the foreseen temperature range. Suitable for the connection of machine tools, control equipment and assembly lines, adjustment and measuring instruments and computer units. Suitable both for fixed and for mobile installation if there are no high mechanical stresses.

Reference Construction Products Regulation 305/2011 EU and Standard EN 50575:
The cable is suitable for the supply of electricity in buildings and other civil engineering works.

FEATURES AND PERFORMANCES

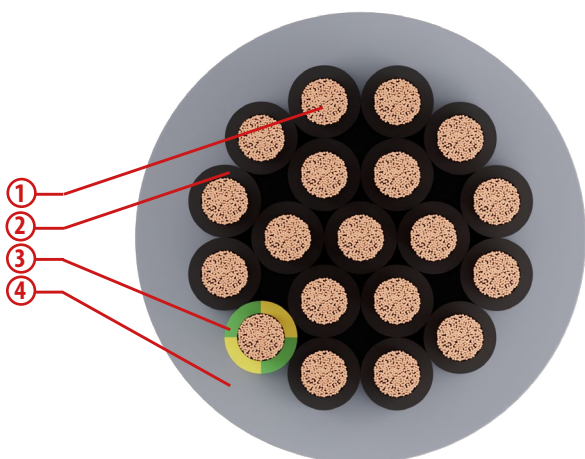

CONSTRUCTION

1. CLASS 5, FLEXIBLE, PLAIN COPPER WIRE
2. SPECIAL PVC
3. THERMOPLASTIC (OPTIONAL)
4. PVC

Structure and electrical, physical, mechanical requirements: VDE Reg. n°7509 according to EN 50525-2-51

- Low Voltage Directive 2014/35/EU
- RoHS Directive 2011/65/EU

Installation conditions	
Minimum installation temperature	-5°C
Recommended min. bending radius	6 times the cable diameter for static use, 15 times the cable diameter for mobile use
Recommended maximum tensile stress	50 N/mm ² of the cross-section of the copper

Functional characteristics	
Rated voltage U _o /U	300/500 V
Max. operating temperature	70°C
Min. operating temperature	-40°C (without mechanical shocks)
Max. short circuit temperature	150°C

Marking

Tratos YSLY-JZ/OZ [form.] Eca <VDE-REG 7509> [year] [metric]

Colours

TWO-CORE



THREE-CORE



FOUR-CORE



FIVE-CORE



MULTI-CORE (>5 CORES)



YSLY-JZ numbered cores with conductor green/yellow
YSLY-OZ numbered cores without conductor green/yellow

Formation	Approx. conductor Ø	Average insulation thickness	Average sheath thickness	Max. external Ø	Max. electrical resistance at 20°C	Approx. cable weight
n° x mm ²	mm	mm	mm	mm	Ω/km	kg/km
2 x 0,5	0,9	0,4	0,7	4,5	39,0	30
3 x 0,5	0,9	0,4	0,7	4,8	39,0	36
4 x 0,5	0,9	0,4	0,7	5,1	39,0	43
5 x 0,5	0,9	0,4	0,7	5,6	39,0	53
6 x 0,5	0,9	0,4	0,8	6,3	39,0	65
7 x 0,5	0,9	0,4	0,8	6,2	39,0	69
10 x 0,5	0,9	0,4	0,9	7,6	39,0	96
12 x 0,5	0,9	0,4	0,9	8,1	39,0	110
14 x 0,5	0,9	0,4	1,0	9,0	39,0	130
16 x 0,5	0,9	0,4	1,0	9,4	39,0	148
18 x 0,5	0,9	0,4	1,0	9,9	39,0	165
21 x 0,5	0,9	0,4	1,1	10,6	39,0	195
25 x 0,5	0,9	0,4	1,2	11,4	39,0	220
27 x 0,5	0,9	0,4	1,2	12,2	39,0	239
34 x 0,5	0,9	0,4	1,3	13,2	39,0	295
40 x 0,5	0,9	0,4	1,3	14,2	39,0	350
41 x 0,5	0,9	0,4	1,4	15,0	39,0	365
42 x 0,5	0,9	0,4	1,4	15,0	39,0	370
52 x 0,5	0,9	0,4	1,5	16,0	39,0	445
61 x 0,5	0,9	0,4	1,6	17,5	39,0	515
65 x 0,5	0,9	0,4	1,6	18,1	39,0	560

Formation	Approx. conductor Ø	Average insulation thickness	Average sheath thickness	Max. external Ø	Max. electrical resistance at 20°C	Approx. cable weight
n° x mm ²	mm	mm	mm	mm	Ω/km	kg/km
2 x 0,75	1,1	0,4	0,7	4,9	26,0	38
3 x 0,75	1,1	0,4	0,7	5,2	26,0	46
4 x 0,75	1,1	0,4	0,7	5,7	26,0	56
5 x 0,75	1,1	0,4	0,8	6,2	26,0	71
6 x 0,75	1,1	0,4	0,8	6,9	26,0	84
7 x 0,75	1,1	0,4	0,8	6,9	26,0	88
10 x 0,75	1,1	0,4	1,0	8,5	26,0	130
12 x 0,75	1,1	0,4	1,0	9,1	26,0	150
14 x 0,75	1,1	0,4	1,0	9,6	26,0	170
16 x 0,75	1,1	0,4	1,1	10,6	26,0	200
18 x 0,75	1,1	0,4	1,1	11,1	26,0	220
21 x 0,75	1,1	0,4	1,2	11,9	26,0	250
25 x 0,75	1,1	0,4	1,3	12,7	26,0	295
27 x 0,75	1,1	0,4	1,3	13,6	26,0	320
32 x 0,75	1,1	0,4	1,4	14,4	26,0	385
34 x 0,75	1,1	0,4	1,4	14,8	26,0	395
42 x 0,75	1,1	0,4	1,5	16,7	26,0	495
52 x 0,75	1,1	0,4	1,6	17,8	26,0	590
61 x 0,75	1,1	0,4	1,7	19,5	26,0	690

TRATOS General Cables®

Formation	Approx. conductor Ø	Average insulation thickness	Average sheath thickness	Approx. external Ø	Max. electrical resistance at 20°C	Approx. cable weight
n° x mm ²	mm	mm	mm	mm	Ω/km	kg/km
2 x 1	1,3	0,4	0,7	5,2	19,5	45
3 x 1	1,3	0,4	0,7	5,5	19,5	55
4 x 1	1,3	0,4	0,8	6,2	19,5	70
5 x 1	1,3	0,4	0,8	6,8	19,5	85
6 x 1	1,3	0,4	0,9	7,6	19,5	105
7 x 1	1,3	0,4	0,9	7,6	19,5	110
10 x 1	1,3	0,4	1,0	9,7	19,5	155
12 x 1	1,3	0,4	1,0	9,7	19,5	180
14 x 1	1,3	0,4	1,1	10,7	19,5	210
16 x 1	1,3	0,4	1,1	11,3	19,5	240
18 x 1	1,3	0,4	1,2	12,1	19,5	275
21 x 1	1,3	0,4	1,2	12,7	19,5	320
25 x 1	1,3	0,4	1,3	13,6	19,5	360
27 x 1	1,3	0,4	1,3	14,5	19,5	390
32 x 1	1,3	0,4	1,4	15,8	19,5	470
34 x 1	1,3	0,4	1,5	16,0	19,5	490
42 x 1	1,3	0,4	1,6	18,1	19,5	615
52 x 1	1,3	0,4	1,7	19,3	19,5	735
61 x 1	1,3	0,4	1,8	21,1	19,5	855

Formation	Approx. conductor Ø	Average insulation thickness	Average sheath thickness	Approx. external Ø	Max. electrical resistance at 20°C	Approx. cable weight
n° x mm ²	mm	mm	mm	mm	Ω/km	kg/km
2 x 1,5	1,5	0,4	0,8	6,0	13,3	60
3 x 1,5	1,5	0,4	0,8	6,4	13,3	75
4 x 1,5	1,5	0,4	0,8	7,0	13,3	93
5 x 1,5	1,5	0,4	0,9	7,8	13,3	120
6 x 1,5	1,5	0,4	0,9	8,4	13,3	140
7 x 1,5	1,5	0,4	0,9	8,4	13,3	150
10 x 1,5	1,5	0,4	1,1	10,6	13,3	215
12 x 1,5	1,5	0,4	1,1	11,1	13,3	250
14 x 1,5	1,5	0,4	1,2	12,2	13,3	290
16 x 1,5	1,5	0,4	1,2	12,9	13,3	330
18 x 1,5	1,5	0,4	1,3	13,7	13,3	375
21 x 1,5	1,5	0,4	1,3	14,5	13,3	440
25 x 1,5	1,5	0,4	1,5	15,6	13,3	505
27 x 1,5	1,5	0,4	1,5	16,7	13,3	550
32 x 1,5	1,5	0,4	1,6	18,2	13,3	650
34 x 1,5	1,5	0,4	1,6	18,2	13,3	670
42 x 1,5	1,5	0,4	1,7	20,5	13,3	840
52 x 1,5	1,5	0,4	1,9	21,8	13,3	1020
61 x 1,5	1,5	0,4	2,0	24,1	13,3	1185

Formation	Approx. conductor Ø	Average insulation thickness	Average sheath thickness	Approx. external Ø	Max. electrical resistance at 20°C	Approx. cable weight
n° x mm ²	mm	mm	mm	mm	Ω/km	kg/km
2 x 2,5	2,0	0,5	0,8	7,2	7,98	91
3 x 2,5	2,0	0,5	0,9	7,9	7,98	120
4 x 2,5	2,0	0,5	0,9	8,6	7,98	145
5 x 2,5	2,0	0,5	1,0	9,6	7,98	185
7 x 2,5	2,0	0,5	1,1	10,6	7,98	240
12 x 2,5	2,0	0,5	1,3	13,9	7,98	395
18 x 2,5	2,0	0,5	1,5	17,1	7,98	595
25 x 2,5	2,0	0,5	1,7	19,4	7,98	795
32 x 2,5	2,0	0,5	1,9	22,8	7,98	1040
2 x 4	2,5	0,5	0,9	8,4	4,95	135
3 x 4	2,5	0,5	1,0	9,1	4,95	170
4 x 4	2,5	0,5	1,0	10,0	4,95	215
5 x 4	2,5	0,5	1,1	11,1	4,95	270
7 x 4	2,5	0,5	1,2	12,4	4,95	355
3 x 6	3,0	0,6	1,1	11,0	3,30	250
4 x 6	3,0	0,6	1,2	12,3	3,30	320
5 x 6	3,0	0,6	1,3	13,6	3,30	405
7 x 6	3,0	0,6	1,4	15,0	3,30	525

Formation	Approx. conductor Ø	Average insulation thickness	Average sheath thickness	Approx. external Ø	Max. electrical resistance at 20°C	Approx. cable weight
n° x mm ²	mm	mm	mm	mm	Ω/km	kg/km
4 x 10	4,0	0,7	1,4	15,2	1,91	540
5 x 10	4,0	0,7	1,5	17,0	1,91	670
7 x 10	4,0	0,7	1,6	18,7	1,91	875
4 x 16	5,0	0,7	1,5	17,9	1,21	790
5 x 16	5,0	0,7	1,7	20,0	1,21	990
4 x 25	6,2	0,8	1,8	21,7	0,780	1225
5 x 25	6,2	0,8	2,0	24,2	0,780	1515
4 x 35	7,4	0,8	2,0	25,2	0,554	1670
5 x 35	7,4	0,8	2,2	28,1	0,554	2065
4 x 50	8,9	1,0	2,3	30,2	0,386	2390
4 x 70	10,5	1,0	2,4	34,6	0,272	3292
4 x 95	12,2	1,2	2,4	40,2	0,206	4395
4 x 120	13,8	1,2	2,4	45,0	0,196	5530

TRATOS General Cables®

YSLY-JB | YSLY-OB cable

TRATOS YSLY-JB TRATOS YSLY-OB

For use in dry, humid or wet environments subject to moderate mechanical loads. Can be use outdoor only if protected from UV radiation and within the foreseen temperature range. Suitable for the connection of machine tools, control equipment and assembly lines, adjustment and measuring instruments and computer units. Suitable both for fixed and for mobile installation if there are no high mechanical stresses.

Reference Construction Products Regulation 305/2011 EU and Standard EN 50575:
The cable is suitable for the supply of electricity in buildings and other civil engineering works.

FEATURES AND PERFORMANCES

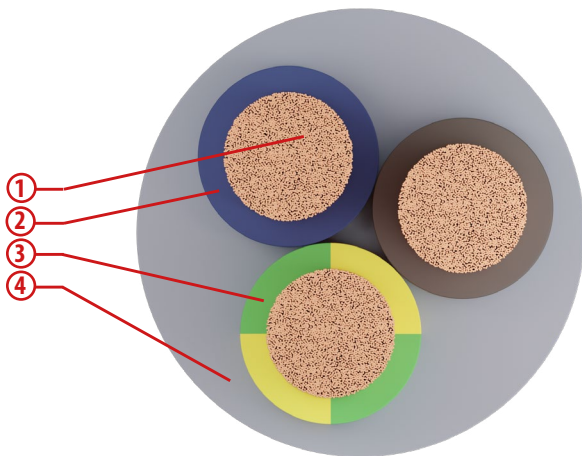

CONSTRUCTION

1. CLASS 5, FLEXIBLE, PLAIN COPPER WIRE
2. SPECIAL PVC
3. THERMOPLASTIC (OPTIONAL)
4. PVC

Structure and electrical, physical, mechanical requirements: VDE Reg. n° 7509 (formations with section $\geq 6 \text{ mm}^2$) according to EN 50525-2-51

- Low Voltage Directive 2014/35/EU
- RoHS Directive 2011/65/EU

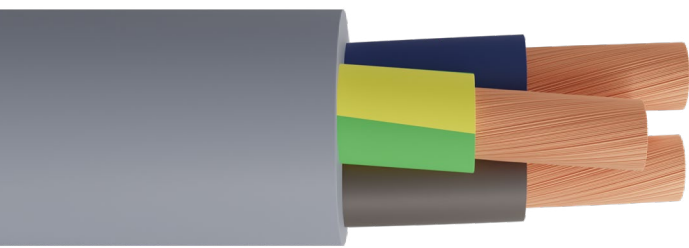

Installation conditions

Minimum installation temperature	-5°C
Recommended min. bending radius	6 times the cable diameter for static use, 15 times the cable diameter for mobile use (only for formations $\leq 5 \times 4$)
Recommended maximum tensile stress	50 N/mm ² of the cross-section of the copper

Marking

Tratos YSLY-JB/OB [form.] Eca [year] [metric]

Tratos YSLY-JB/OB [form.] Eca <VDE-REG 7509> [year] [metric]

Colours

TWO-CORE



THREE-CORE



FOUR-CORE



FIVE-CORE



MULTI-CORE (>5CORES)



Functional characteristics

Rated voltage U ₀ /U	300/500 V
Test voltage	4000 V
Max. operating temperature	70°C
Min. operating temperature	-40°C (without mechanical shocks)
Max. short circuit temperature	150°C

YSLY-JB colored cores with conductor green/yellow
YSLY-OB colored cores without conductor green/yellow

Formation	Approx. conductor Ø	Average insulation thickness	Average sheath thickness	Max. external Ø	Max. electrical resistance at 20°C	Approx. cable weight
n° x mm ²	mm	mm	mm	mm	Ω/km	kg/km
3 x 0,5 *	0,9	0,4	0,7	5,1	39,0	36
4 x 0,5 *	0,9	0,4	0,7	5,5	39,0	44
5 x 0,5 *	0,9	0,4	0,7	6,0	39,0	54
7 x 0,5 *	0,9	0,4	0,8	6,8	39,0	69
2 x 0,75 *	1,1	0,4	0,7	5,2	26,0	38
3 x 0,75 *	1,1	0,4	0,7	5,5	26,0	46
4 x 0,75 *	1,1	0,4	0,7	6,0	26,0	56
5 x 0,75 *	1,1	0,4	0,8	6,8	26,0	71
7 x 0,75 *	1,1	0,4	0,8	7,3	26,0	88
2 x 1 *	1,3	0,4	0,7	5,5	19,5	45
3 x 1 *	1,3	0,4	0,7	5,8	19,5	55
4 x 1 *	1,3	0,4	0,8	6,6	19,5	71
5 x 1 *	1,3	0,4	0,8	7,2	19,5	87
7 x 1 *	1,3	0,4	0,9	8,0	19,5	110
2 x 1,5 *	1,5	0,4	0,8	6,2	13,3	61
3 x 1,5 *	1,5	0,4	0,8	6,7	13,3	75
4 x 1,5 *	1,5	0,4	0,8	7,3	13,3	93
5 x 1,5 *	1,5	0,4	0,9	8,3	13,3	120
7 x 1,5 *	1,5	0,4	0,9	8,9	13,3	150

* FORMATIONS WITHOUT CERTIFICATION

TRATOS General Cables®

YSLY-JB colored cores with conductor green/yellow
YSLY-OB colored cores without conductor green/yellow

Formation n° x mm ²	Approx. conductor Ø mm	Average insulation thickness mm	Average sheath thickness mm	Approx. external Ø mm	Max. electrical resistance at 20°C Ω/km	Approx. cable weight kg/km
2 x 2,5 *	2,0	0,5	0,8	7,6	7,98	92
3 x 2,5 *	2,0	0,5	0,9	8,2	7,98	120
4 x 2,5 *	2,0	0,5	0,9	9,0	7,98	150
5 x 2,5 *	2,0	0,5	1,0	10,0	7,98	185
7 x 2,5 *	2,0	0,5	1,1	11,1	7,98	240
2 x 4 *	2,5	0,5	0,9	8,8	4,95	135
3 x 4 *	2,5	0,5	1,0	9,5	4,95	175
4 x 4 *	2,5	0,5	1,0	10,5	4,95	215
5 x 4 *	2,5	0,5	1,1	11,7	4,95	270
2 x 6	3,0	0,6	1,0	10,4	3,30	195
3 x 6	3,0	0,6	1,1	11,4	3,30	250
4 x 6	3,0	0,6	1,2	12,8	3,30	320
5 x 6	3,0	0,6	1,3	14,3	3,30	405
4 x 10	4,0	0,7	1,4	15,8	1,91	540
5 x 10	4,0	0,7	1,7	17,5	1,91	670
3 x 16	5,0	0,7	1,4	16,6	1,21	630
4 x 16	5,0	0,7	1,5	18,4	1,21	790
5 x 16	5,0	0,7	1,7	20,7	1,21	990
4 x 25	6,2	0,8	1,8	22,4	0,78	1225
5 x 25	6,2	0,8	2,0	25,0	0,78	1515
3 x 35	7,4	0,8	1,8	23,0	0,554	1300
4 x 35	7,4	0,8	2,0	25,8	0,554	1670
5 x 35	7,4	0,8	2,2	28,7	0,554	2065
4 x 50	8,9	1,0	2,3	31,0	0,386	2390
5 x 50	8,9	1,0	2,6	34,6	0,386	3000
4 x 70	10,5	1,0	2,6	35,7	0,272	3305
5 x 70	10,5	1,0	2,9	40,1	0,272	4110
4 x 95	12,2	1,2	3,0	41,3	0,206	4400
5 x 95	12,2	1,2	3,3	46,4	0,206	5380
4 x 120	13,6	1,2	3,3	45,0	0,196	5530
5 x 120	13,6	1,2	3,6	50,8	0,196	7000

* FORMATIONS WITHOUT CERTIFICATION

CABLES FOR A MOVING WORLD

TRATOS[®] ENERGY DNOs

Tratos Utility cables are designed and tested to meet relevant UK, European and International standards. Manufactured in state of the art manufacturing facilities, the company's purpose-built, in-house Fire, Chemical, Electrical and Physical testing facilities and laboratories deliver peace of mind to customers ensuring their choice of Utility cable products meet all statutory and regulatory requirements.



www.tratosgroup.com



TRATOS General Cables®

YSLY-JZ | YSLY-OZ cable

TRATOS YSLY-JZ-300/500 V TRATOS YSLY-OZ-300/500 V

For use in dry, humid or wet environments subject to moderate mechanical loads. Can be use outdoor only if protected from UV radiation and within the foreseen temperature range. Suitable for the connection of machine tools, control equipment and assembly lines, adjustment and measuring instruments and computer units. Suitable both for fixed and for mobile installation if there are no high mechanical stresses.

Reference Construction Products Regulation 305/2011 EU and Standard EN 50575:
The cable is suitable for the supply of electricity in buildings and other civil engineering works.

FEATURES AND PERFORMANCES

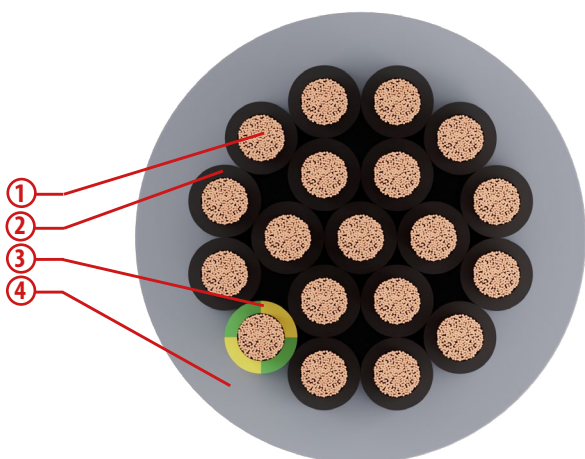

CONSTRUCTION

1. CLASS 5, FLEXIBLE, PLAIN COPPER WIRE
2. SPECIAL PVC
3. THERMOPLASTIC (OPTIONAL)
4. PVC

Structure and electrical, physical, mechanical requirements: VDE Reg. n°7509 according to EN 50525-2-51



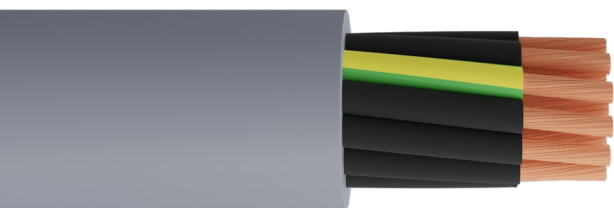

- Low Voltage Directive 2014/35/EU
- RoHS Directive 2011/65/EU



Marking

Tratos YSLY-JZ/OZ [form.] Eca <VDE-REG 7509> [year] [metric]

Colours

- TWO-CORE 
- THREE-CORE  or 
- FOUR-CORE  or 
- FIVE-CORE  or 

Installation conditions

Minimum installation temperature	-5°C
Recommended min. bending radius	6 times the cable diameter for static use, 15 times the cable diameter for mobile use
Recommended maximum tensile stress	50 N/mm ² of the cross-section of the copper

Functional characteristics

Rated voltage U ₀ /U	300/500 V
Max. operating temperature	70°C
Min. operating temperature	-40°C (without mechanical shocks)
Max. short circuit temperature	150°C

YSLY-JZ numbered cores with conductor green/yellow
YSLY-OZ numbered cores without conductor green/yellow

Formation	Approx. conductor Ø	Average insulation thickness	Average sheath thickness	Max. external Ø	Max. electrical resistance at 20°C	Approx. cable weight
n° x mm ²	mm	mm	mm	mm	Ω/km	kg/km
2 x 0,5	0,9	0,4	0,7	4,5	39,0	30
3 x 0,5	0,9	0,4	0,7	4,8	39,0	36
4 x 0,5	0,9	0,4	0,7	5,1	39,0	43
5 x 0,5	0,9	0,4	0,7	5,6	39,0	43
6 x 0,5	0,9	0,4	0,8	6,3	39,0	65
7 x 0,5	0,9	0,4	0,8	6,2	39,0	69
10 x 0,5	0,9	0,4	0,9	7,6	39,0	96
12 x 0,5	0,9	0,4	0,9	8,1	39,0	110
14 x 0,5	0,9	0,4	1,0	9,0	39,0	130
16 x 0,5	0,9	0,4	1,0	9,4	39,0	148
18 x 0,5	0,9	0,4	1,0	9,9	39,0	165
21 x 0,5	0,9	0,4	1,1	10,6	39,0	195
25 x 0,5	0,9	0,4	1,2	11,4	39,0	220
27 x 0,5	0,9	0,4	1,2	12,2	39,0	239
34 x 0,5	0,9	0,4	1,3	13,2	39,0	295
40 x 0,5	0,9	0,4	1,3	14,2	39,0	350
41 x 0,5	0,9	0,4	1,4	15,0	39,0	365
42 x 0,5	0,9	0,4	1,4	15,0	39,0	370
52 x 0,5	0,9	0,4	1,5	16,0	39,0	445
61 x 0,5	0,9	0,4	1,6	17,5	39,0	515
65 x 0,5	0,9	0,4	1,6	18,1	39,0	560

Formation	Approx. conductor Ø	Average insulation thickness	Average sheath thickness	Max. external Ø	Max. electrical resistance at 20°C	Approx. cable weight
n° x mm ²	mm	mm	mm	mm	Ω/km	kg/km
2 x 0,75	1,1	0,4	0,7	4,9	26,0	38
3 x 0,75	1,1	0,4	0,7	5,2	26,0	46
4 x 0,75	1,1	0,4	0,7	5,7	26,0	56
5 x 0,75	1,1	0,4	0,8	6,2	26,0	71
6 x 0,75	1,1	0,4	0,8	6,9	26,0	84
7 x 0,75	1,1	0,4	0,8	6,9	26,0	88
10 x 0,75	1,1	0,4	1,0	8,5	26,0	130
12 x 0,75	1,1	0,4	1,0	9,1	26,0	150
14 x 0,75	1,1	0,4	1,0	9,6	26,0	170
16 x 0,75	1,1	0,4	1,1	10,6	26,0	200
18 x 0,75	1,1	0,4	1,1	11,1	26,0	220
21 x 0,75	1,1	0,4	1,2	11,9	26,0	250
25 x 0,75	1,1	0,4	1,3	12,7	26,0	295
27 x 0,75	1,1	0,4	1,3	13,6	26,0	320
32 x 0,75	1,1	0,4	1,4	14,4	26,0	385
34 x 0,75	1,1	0,4	1,4	14,8	26,0	395
42 x 0,75	1,1	0,4	1,5	16,7	26,0	495
52 x 0,75	1,1	0,4	1,6	17,8	26,0	590
61 x 0,75	1,1	0,4	1,7	19,5	26,0	690

TRATOS General Cables®

Formation n° x mm ²	Approx. conductor Ø mm	Average insulation thickness mm	Average sheath thickness mm	Max. external Ø mm	Max. electrical resistance at 20°C Ω/km	Approx. cable weight kg/km
2 x 1	1,3	0,4	0,7	5,2	19,5	45
3 x 1	1,3	0,4	0,7	5,5	19,5	55
4 x 1	1,3	0,4	0,8	6,2	19,5	70
5 x 1	1,3	0,4	0,8	6,8	19,5	85
6 x 1	1,3	0,4	0,9	7,6	19,5	105
7 x 1	1,3	0,4	0,9	7,6	19,5	110
10 x 1	1,3	0,4	1,0	9,7	19,5	155
12 x 1	1,3	0,4	1,0	9,7	19,5	180
14 x 1	1,3	0,4	1,1	10,7	19,5	210
16 x 1	1,3	0,4	1,1	11,3	19,5	240
18 x 1	1,3	0,4	1,2	12,1	19,5	275
21 x 1	1,3	0,4	1,2	12,7	19,5	320
25 x 1	1,3	0,4	1,3	13,6	19,5	360
27 x 1	1,3	0,4	1,3	14,5	19,5	390
32 x 1	1,3	0,4	1,4	15,8	19,5	470
34 x 1	1,3	0,4	1,5	16,0	19,5	490
42 x 1	1,3	0,4	1,6	18,1	19,5	615
52 x 1	1,3	0,4	1,7	19,3	19,5	735
61 x 1	1,3	0,4	1,8	21,1	19,5	855

Formation n° x mm ²	Approx. conductor Ø mm	Average insulation thickness mm	Average sheath thickness mm	Max. external Ø mm	Max. electrical resistance at 20°C Ω/km	Approx. cable weight kg/km
2 x 1,5	1,5	0,4	0,8	6,0	13,3	60
3 x 1,5	1,5	0,4	0,8	6,4	13,3	75
4 x 1,5	1,5	0,4	0,8	7,0	13,3	93
5 x 1,5	1,5	0,4	0,9	7,8	13,3	120
6 x 1,5	1,5	0,4	0,9	8,4	13,3	140
7 x 1,5	1,5	0,4	0,9	8,4	13,3	150
10 x 1,5	1,5	0,4	1,1	10,6	13,3	215
12 x 1,5	1,5	0,4	1,1	11,1	13,3	250
14 x 1,5	1,5	0,4	1,2	12,2	13,3	290
16 x 1,5	1,5	0,4	1,2	12,9	13,3	330
18 x 1,5	1,5	0,4	1,3	13,7	13,3	375
21 x 1,5	1,5	0,4	1,3	14,5	13,3	440
25 x 1,5	1,5	0,4	1,5	15,6	13,3	505
27 x 1,5	1,5	0,4	1,5	16,7	13,3	550
32 x 1,5	1,5	0,4	1,6	18,2	13,3	650
34 x 1,5	1,5	0,4	1,6	18,2	13,3	670
42 x 1,5	1,5	0,4	1,7	20,5	13,3	840
52 x 1,5	1,5	0,4	1,9	21,8	13,3	1020
61 x 1,5	1,5	0,4	2,0	24,1	13,3	1185

Formation	Approx. conductor Ø	Average insulation thickness	Average sheath thickness	Max. external Ø	Max. electrical resistance at 20°C	Approx. cable weight
n° x mm ²	mm	mm	mm	mm	Ω/km	kg/km
2 x 2,5	2,0	0,5	0,8	7,2	7,98	91
3 x 2,5	2,0	0,5	0,9	7,9	7,98	120
4 x 2,5	2,0	0,5	0,9	8,6	7,98	145
5 x 2,5	2,0	0,5	1,0	9,6	7,98	185
7 x 2,5	2,0	0,5	1,1	10,6	7,98	240
12 x 2,5	2,0	0,5	1,3	13,9	7,98	395
18 x 2,5	2,0	0,5	1,5	17,1	7,98	595
25 x 2,5	2,0	0,5	1,7	19,4	7,98	795
32 x 2,5	2,0	0,5	1,9	22,8	7,98	1040
2 x 4	2,5	0,5	0,9	8,4	4,95	135
3 x 4	2,5	0,5	1,0	9,1	4,95	170
4 x 4	2,5	0,5	1,0	10,0	4,95	215
5 x 4	2,5	0,5	1,1	11,1	4,95	270
7 x 4	2,5	0,5	1,2	12,4	4,95	355
3 x 6	3,0	0,6	1,1	11,0	3,30	250
4 x 6	3,0	0,6	1,2	12,3	3,30	320
5 x 6	3,0	0,6	1,3	13,6	3,30	405
7 x 6	3,0	0,6	1,4	15,0	3,30	525

Formation	Approx. conductor Ø	Average insulation thickness	Average sheath thickness	Max. external Ø	Max. electrical resistance at 20°C	Approx. cable weight
n° x mm ²	mm	mm	mm	mm	Ω/km	kg/km
4 x 10	4,0	0,7	1,4	15,2	1,91	540
5 x 10	4,0	0,7	1,5	17,0	1,91	670
7 x 10	4,0	0,7	1,6	18,7	1,91	875
4 x 16	5,0	0,7	1,5	17,9	1,21	790
5 x 16	5,0	0,7	1,7	20,0	1,21	990
4 x 25	6,2	0,8	1,8	21,7	0,780	1225
5 x 25	6,2	0,8	2,0	24,2	0,780	1515
4 x 35	7,4	0,8	2,0	25,2	0,554	1670
5 x 35	7,4	0,8	2,2	28,1	0,554	2065
4 x 50	8,9	1,0	2,3	30,2	0,386	2390
4 x 70	10,5	1,0	2,4	34,6	0,272	3292
4 x 95	12,2	1,2	2,4	40,2	0,206	4395
4 x 120	13,8	1,2	2,4	45,0	0,196	5530

TRATOS General Cables®

YSLY CY-JB | YSLY-OZ cable

TRATOS YSLY CY-JB TRATOS YSLY CY-OB

For use in dry, humid or wet environments subject to moderate mechanical loads. Can be use outdoor only if protected from UV radiation and within the foreseen temperature range. Suitable for the connection of machine tools, control equipment and assembly lines, adjustment and measuring instruments and computer units. Suitable both for fixed and for mobile installation if there are no high mechanical stresses. The screen offers protection from electromagnetic interference.

Reference Construction Products Regulation 305/2011 EU and Standard EN 50575:
The cable is suitable for the supply of electricity in buildings and other civil engineering works.

FEATURES AND PERFORMANCES

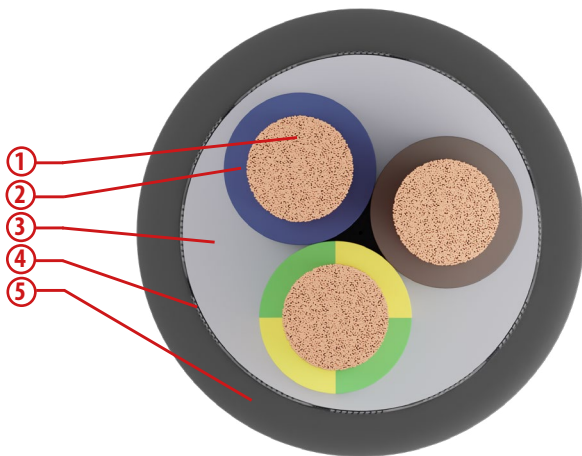

CONSTRUCTION

1. CLASS 5, FLEXIBLE, PLAIN COPPER WIRE
2. SPECIAL PVC
3. THERMOPLASTIC
4. TINNED COPPER BRAID
5. PVC

Structure and electrical, physical, mechanical requirements: EN 50363-4-1 ref. to EN 50525-2-51

- **Low Voltage Directive** 2014/35/EU
- **RoHS Directive** 2011/65/EU

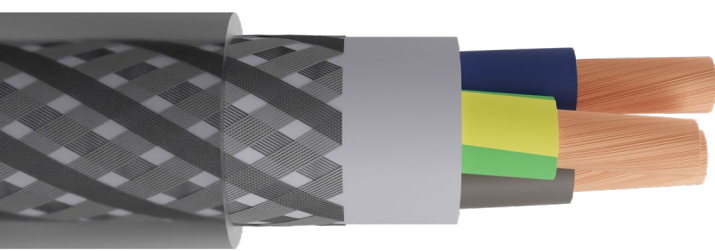

Installation conditions	
Minimum installation temperature	-5°C
Recommended min. bending radius	10 times the cable diameter for static use, 20 times the cable diameter for mobile use
Recommended maximum tensile stress	50 N/mm ² of the cross-section of the copper

Functional characteristics	
Rated voltage U ₀ /U	300/500 V
Max. operating temperature	70°C
Min. operating temperature	-40°C (without mechanical shocks)
Max. short circuit temperature	150°C

Marking

Tratos YSLY CY-JB/OB [form.] Eca [year] [metric]
Tratos YSLY CY-JB/OB [form.] Eca <VDE-REG 7509> [year] [metric]

Colours

- TWO-CORE
- THREE-CORE or
- FOUR-CORE or
- FIVE-CORE or

YSLY CY-JB colored cores with conductor green/yellow
YSLY CY-OB colored cores without conductor green/yellow

Formation	Approx. conductor Ø	Average insulation thickness	Average sheath thickness	Approx. external Ø	Max. electrical resistance at 20°C	Approx. cable weight
n° x mm ²	mm	mm	mm	mm	Ω/km	kg/km
2 x 0,5 *	0,9	0,4	0,8	6,9	39,0	68
3 x 0,5 *	0,9	0,4	0,8	7,2	39,0	70
4 x 0,5 *	0,9	0,4	0,9	7,8	39,0	90
5 x 0,5 *	0,9	0,4	0,9	8,3	39,0	100
2 x 0,75 *	1,1	0,4	0,8	7,3	26,0	80
3 x 0,75 *	1,1	0,4	0,9	7,8	26,0	95
4 x 0,75 *	1,1	0,4	0,9	8,3	26,0	110
5 x 0,75 *	1,1	0,4	0,9	8,9	26,0	125
2 x 1 *	1,3	0,4	0,9	7,8	19,5	90
3 x 1 *	1,3	0,4	0,9	8,1	19,5	105
4 x 1 *	1,3	0,4	0,9	8,7	19,5	125
5 x 1 *	1,3	0,4	1,0	9,5	19,5	145
2 x 1,5 *	1,5	0,4	0,9	8,4	13,3	115
3 x 1,5 *	1,5	0,4	0,9	8,8	13,3	130
4 x 1,5 *	1,5	0,4	1,0	9,6	13,3	155
5 x 1,5 *	1,5	0,4	1,0	10,4	13,3	185
2 x 2,5 *	2,0	0,5	1,0	9,9	7,98	130
3 x 2,5 *	2,0	0,5	1,0	10,3	7,98	180
4 x 2,5 *	2,0	0,5	1,1	11,3	7,98	220
5 x 2,5 *	2,0	0,5	1,2	12,6	7,98	280
2 x 4 *	2,5	0,5	1,1	11,1	4,95	180
3 x 4 *	2,5	0,5	1,1	11,6	4,95	250
4 x 4 *	2,5	0,5	1,2	13,1	4,95	315
5 x 4 *	2,5	0,5	1,3	14,3	4,95	385

* Formations without VDE certification

Formation	Approx. conductor Ø	Average insulation thickness	Average sheath thickness	Approx. external Ø	Max. electrical resistance at 20°C	Approx. cable weight
n° x mm ²	mm	mm	mm	mm	Ω/km	kg/km
3 x 6	3,0	0,6	1,3	14,1	3,30	340
4 x 6	3,0	0,6	1,4	15,6	3,30	455
5 x 6	3,0	0,6	1,5	17,1	3,30	555
3 x 10	4,0	0,7	1,5	17,5	1,91	605
4 x 10	4,0	0,7	1,6	18,6	1,91	705
5 x 10	4,0	0,7	1,7	20,5	1,91	875
4 x 16	5,0	0,7	1,7	21,4	1,21	1000
5 x 16	5,0	0,7	1,9	23,6	1,21	1230
4 x 25	6,2	0,8	2,0	25,7	0,78	1480
5 x 25	6,2	0,8	2,2	29,0	0,78	1930
4 x 35	7,4	0,8	2,2	29,3	0,554	1980
5 x 35	7,4	0,8	2,4	32,0	0,554	2400
4 x 50	8,9	1,0	2,6	34,7	0,386	2700
4 x 70	10,5	1,0	2,9	39,8	0,272	3880
4 x 95	12,2	1,2	3,3	45,4	0,206	5070
4 x 120	13,8	1,2	3,6	50,2	0,196	6280

TRATOS General Cables®

YSLY-JZ 0,6/1 kV | YSLY-OZ 0,6/1 kV cable

TRATOS YSLY-JZ 0,6/1 kV TRATOS YSLY-OZ 0,6/1 kV

Suitable for energy supply in industry, workshops and residential building. Suitable for indoor and outdoor static laying. Installation on masonries, metallic structures, footbridges, ducts, grooves and similar structures. Suitable for both static and mobile installations as long as the cable is not highly tensioned.

Reference Construction Products Regulation 305/201 EU and Standard EN 50575:
The cable is suitable for the supply of electricity in buildings and other civil engineering works.

FEATURES AND PERFORMANCES

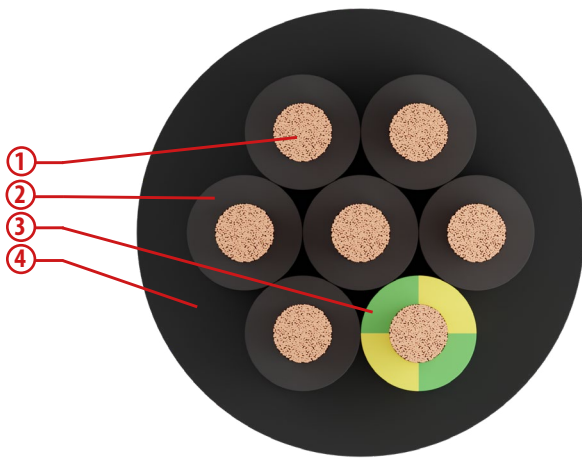

CONSTRUCTION

1. CLASS 5, FLEXIBLE, PLAIN COPPER WIRE
2. SPECIAL PVC
3. THERMOPLASTIC FILLING COMPOUND (OPTIONAL)
4. SPECIAL PVC

Structure and electrical, physical, mechanical requirements:

- Low Voltage Directive 2014/35/EU
- RoHS Directive 2011/65/EU

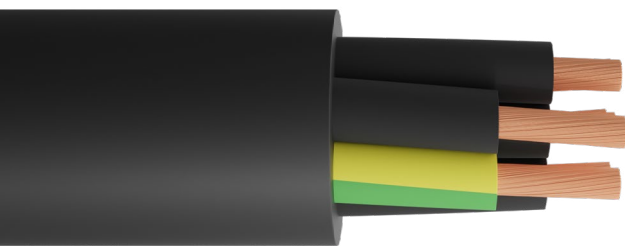

Installation conditions	
Minimum installation temperature	-5°C
Recommended min. bending radius	6 times the cable diameter
Recommended maximum tensile stress	50 N/mm ² of the cross-section of the copper

Functional characteristics	
Rated voltage U ₀ /U	0,6/1 kV
Test Voltage	4000 V
Max. operating temperature	70°C
Min. operating temperature	-20°C (without mechanical shocks)
Max. short circuit temperature	150°C

Marking

Tratos YSLY-OZ 0,6/1 kV [form.] [traceability] [year] [metric]

Colours

TWO-CORE



THREE-CORE



FOUR-CORE



FIVE-CORE



MULTI-CORE (>5 cores)



YSLY-JZ 0,6/1 kV numbered cores with conductor green/yellow
 YSLY-OZ 0,6/1 kV numbered cores without conductor green/yellow

Formation	Approx. conductor Ø	Average insulation thickness	Average sheath thickness	Approx. external Ø	Max. electrical resistance at 20°C	Approx. cable weight
n° x mm ²	mm	mm	mm	mm	Ω/km	kg/km
5 x 0,5	0,9	0,6	1,1	7,4	39,0	83
3 x 0,75	1,1	0,6	1,0	6,7	26,0	69
4 x 0,75	1,1	0,6	1,0	7,2	26,0	82
5 x 0,75	1,1	0,6	1,1	8,0	26,0	103
7 x 0,75	1,1	0,6	1,2	8,9	26,0	130
2 x 1	1,3	0,6	1,0	6,6	19,5	67
3 x 1	1,3	0,6	1,0	7,0	19,5	79
4 x 1	1,3	0,6	1,1	7,8	19,5	99
5 x 1	1,3	0,6	1,2	8,5	19,5	120
7 x 1	1,3	0,6	1,2	9,4	19,5	152
12 x 1	1,3	0,6	1,4	12,1	19,5	247
18 x 1	1,3	0,6	1,6	14,9	19,5	367
25 x 1	1,3	0,6	1,8	17,6	19,5	494
2 x 1,5	1,5	0,7	1,1	7,7	13,3	93
3 x 1,5	1,5	0,7	1,1	8,2	13,3	110
4 x 1,5	1,5	0,7	1,2	9,1	13,3	137
5 x 1,5	1,5	0,7	1,3	9,9	13,3	167
6 x 1,5	1,5	0,7	1,3	10,9	13,3	201
7 x 1,5	1,5	0,7	1,3	10,9	13,3	211
8 x 1,5	1,5	0,7	1,5	12,1	13,3	246
12 x 1,5	1,5	0,7	1,6	14,3	13,3	349
18 x 1,5	1,5	0,7	1,8	17,5	13,3	518
25 x 1,5	1,5	0,7	2,1	20,9	13,3	705
27 x 1,5	1,5	0,7	2,1	21,3	13,3	747
2 x 2,5	2,0	0,8	1,2	9,2	7,98	114
3 x 2,5	2,0	0,8	1,2	9,8	7,98	141
4 x 2,5	2,0	0,8	1,3	10,9	7,98	170
5 x 2,5	2,0	0,8	1,4	12,0	7,98	210
7 x 2,5	2,0	0,8	1,5	13,3	7,98	321
12 x 2,5	2,0	0,8	1,8	17,3	7,98	530
18 x 2,5	2,0	0,8	2,0	21,2	7,98	784
19 x 2,5	2,0	0,8	2,0	21,2	7,98	799
20 x 2,5	2,0	0,8	2,1	22,5	7,98	879
25 x 2,5	2,0	0,8	2,3	25,2	7,98	1062
27 x 2,5	2,0	0,8	2,3	25,7	7,98	1128
30 x 2,5	2,0	0,8	2,6	27,0	7,98	1256

TRATOS General Cables®

Formation	Approx. conductor Ø	Average insulation thickness	Average sheath thickness	Approx. external Ø	Max. electrical resistance at 20°C	Approx. cable weight
n° x mm ²	mm	mm	mm	mm	Ω/km	kg/km
3 x 4	2,5	0,8	1,3	11,0	4,95	225
4 x 4	2,5	0,8	1,4	12,3	4,95	282
5 x 4	2,5	0,8	1,5	13,6	4,95	351
3 x 6	3,0	3,0	1,4	12,4	3,30	303
4 x 6	3,0	3,0	1,5	13,8	3,30	381
5 x 6	3,0	3,0	1,6	15,3	3,30	475
4 x 10	3,9	1,0	1,8	17,5	1,91	635
5 x 10	3,9	1,0	1,9	19,4	1,91	787
3 x 16	4,9	1,0	1,8	18,3	1,21	749
4 x 16	4,9	1,0	2,0	20,5	1,21	963
5 x 16	4,9	1,0	2,2	22,8	1,21	1200
4 x 25	6,2	1,2	2,3	25,0	0,780	1467
5 x 25	6,2	1,2	2,5	27,8	0,780	1804
4 x 35	7,3	1,2	2,5	28,2	0,554	1931
5 x 35	7,3	1,2	2,7	31,3	0,554	2379
4 x 50	8,7	1,4	2,9	33,4	0,386	2722
4 x 70	10,4	1,4	3,3	38,3	0,272	3741
5 x 70	10,4	1,4	3,5	42,6	0,272	4586
4 x 95	12,0	1,6	3,6	43,7	0,206	4870
4 x 120	13,6	1,6	3,9	48,4	0,161	6112
5 x 120	13,6	1,6	4,0	53,8	0,161	7478
4 x 150	15,3	2,0	4,0	54,7	0,129	7697
5 x 150	15,3	2,0	4,0	60,1	0,129	9387
4 x 185	16,6	2,0	4,0	58,3	0,106	9110

CABLES FOR A MOVING WORLD

TRATOS[®] ENERGY DNOs

Tratos Utility cables are designed and tested to meet relevant UK, European and International standards. Manufactured in state of the art manufacturing facilities, the company's purpose-built, in-house Fire, Chemical, Electrical and Physical testing facilities and laboratories deliver peace of mind to customers ensuring their choice of Utility cable products meet all statutory and regulatory requirements.



www.tratosgroup.com



TRATOS General Cables®

YSLY-JB 0,6/1 kV | YSLY-OB 0,6/1 kV cable

TRATOS YSLY-JB 0,6/1 kV TRATOS YSLY-OB 0,6/1 kV

Suitable for energy supply in industry, workshops and residential building. Suitable for indoor and outdoor static laying. Installation on masonries, metallic structures, footbridges, ducts, grooves and similar structures. Suitable for both static and mobile installations as long as the cable is not highly tensioned.

Reference Construction Products Regulation 305/2011 EU and Standard EN 50575:
The cable is suitable for the supply of electricity in buildings and other civil engineering works.

FEATURES AND PERFORMANCES

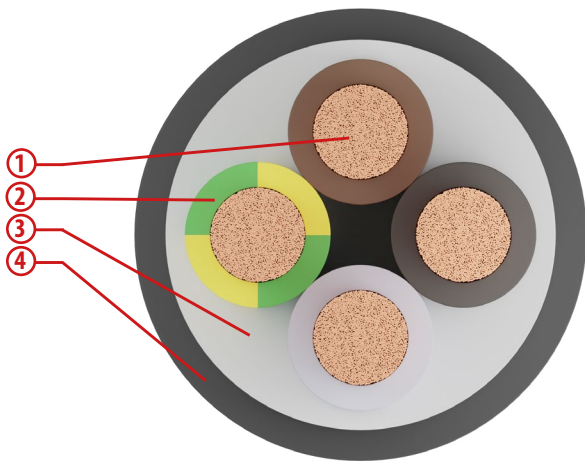

CONSTRUCTION

1. CLASS 5, FLEXIBLE, PLAIN COPPER WIRE
2. SPECIAL PVC
3. THERMOPLASTIC FILLING COMPOUND (OPTIONAL)
4. SPECIAL PVC

Structure and electrical, physical, mechanical requirements:

- Low Voltage Directive 2014/35/EU
- RoHS Directive 2011/65/EU

Installation conditions

Minimum installation temperature	-5°C
Recommended min. bending radius	6 times the cable diameter
Recommended maximum tensile stress	50 N/mm ² of the cross-section of the copper

Functional characteristics

Rated voltage U ₀ /U	0,6/1 kV
Test Voltage	4000 V
Max. operating temperature	70°C
Min. operating temperature	-20°C (without mechanical shocks)
Max. short circuit temperature	150°C

Marking

Tratos YSLY-JB 0,6/1 kV [form.] [traceability] [year] [metric]

Tratos YSLY-OB 0,6/1 kV [form.] [traceability] [year] [metric]

Colours

THREE-CORE  or 
 FOUR-CORE  or 
 FIVE-CORE  or 

YSLY-JB 0,6/1 kV colored cores with conductor green/yellow
 YSLY-OB 0,6/1 kV colored cores without conductor green/yellow

Formation	Approx. conductor Ø	Average insulation thickness	Average sheath thickness	Approx. external Ø	Max. electrical resistance at 20°C	Approx. cable weight
n° x mm ²	mm	mm	mm	mm	Ω/km	kg/km
3 x 1,5	1,5	0,7	1,1	8,6	13,3	115
3 x 2,5	2,0	0,8	1,2	10,1	7,98	165
3 x 4	2,5	0,8	1,3	11,6	4,95	235
3 x 35	7,3	1,2	2,3	26,8	0,554	1495
4 x 1	1,3	0,6	1,1	8,2	19,5	97
4 x 1,5	1,5	0,7	1,2	9,6	13,3	145
4 x 2,5	2,0	0,8	1,3	11,2	7,98	210
4 x 4	2,5	0,8	1,4	12,9	4,95	295
4 x 6	3,0	0,8	1,5	14,5	3,30	400
4 x 10	3,9	1,0	1,8	18,5	1,91	660
4 x 16	4,9	1,0	2,0	22,1	1,21	1010
4 x 70	10,4	1,4	3,3	40,2	0,272	3815
5 x 1,5	1,5	0,7	1,3	10,6	13,3	180
5 x 2,5	2,0	0,8	1,4	12,5	7,98	260
5 x 4	2,5	0,8	1,5	14,3	4,95	365
5 x 6	3,0	0,8	1,6	16,1	3,30	490
5 x 10	3,9	1,0	1,9	20,5	1,91	810
5 x 16	3,9	1,0	2,2	24,7	1,21	1265

TRATOS General Cables®

YSLY CY-JZ 0,6/1 kV/1 kV | YSLY-OB 0,6/1 kV cable

TRATOS YSLY CY-JZ 0,6/1 kV TRATOS YSLY CY-OZ 0,6/1 kV

Suitable for energy supply in industry, workshops and residential building. Suitable for indoor and outdoor static laying. Installation on masonries, metallic structures, footbridges, ducts, grooves and similar structures. The screen offers protection from electromagnetic interference.

Reference Construction Products Regulation 305/2011 EU and Standard EN 50575:
The cable is suitable for the supply of electricity in buildings and other civil engineering works.

FEATURES AND PERFORMANCES

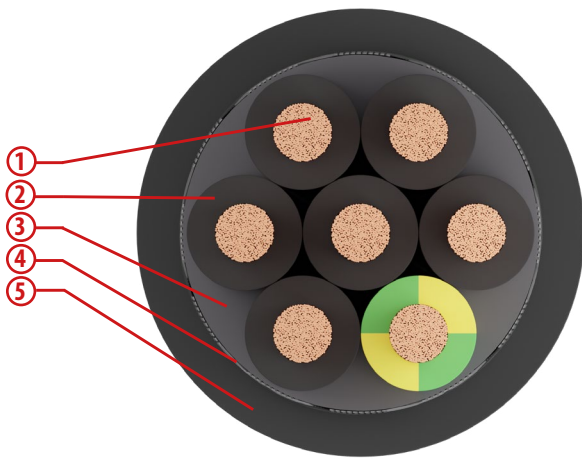

CONSTRUCTION

1. CLASS 5, FLEXIBLE, PLAIN COPPER WIRE
2. SPECIAL PVC
3. THERMOPLASTIC FILLING COMPOUND
4. TINNED COPPER BRAID
5. SPECIAL PVC

Structure and electrical, physical, mechanical requirements:

- **Low Voltage Directive** 2014/35/EU
- **RoHS Directive** 2011/65/EU

Installation conditions

Minimum installation temperature	-5°C
Recommended min. bending radius	8 times the cable diameter
Recommended maximum tensile stress	50 N/mm ² of the cross-section of the copper

Functional characteristics

Rated voltage U _o /U	0,6/1 kV
Test Voltage	4000 V
Max. operating temperature	70°C
Min. operating temperature	-20°C (without mechanical shocks)
Max. short circuit temperature	150°C

Marking

Tratos YSLY-CY-JZ 0,6/1 kV [form.] [year] [traceability] [metric]
Tratos YSLY-CY-OZ 0,6/1 kV [form.] [year] [traceability] [metric]

Colours

- TWO-CORE ●● (OZ)
 THREE-CORE ●●● (JZ) ●●● (OZ)
 FOUR-CORE ●●●● (JZ) ●●●● (OZ)
 FIVE-CORE ●●●●● (JZ) ●●●●● (OZ)
 MULTI-CORE (>5 cores) ●●●●●●●● (JZ) ●●●●●●●● (OZ)

YSLY CY-JZ 0,6/1 kV numbered cores with conductor green/yellow
 YSLY CY-OZ 0,6/1 kV numbered cores without conductor green/yellow

Formation	Approx. conductor Ø	Average insulation thickness	Average sheath thickness	Approx. external Ø	Max. electrical resistance at 20°C	Approx. cable weight
n° x mm ²	mm	mm	mm	mm	Ω/km	kg/km
2 x 2,5	2,0	0,8	1,4	11,9	7,98	215
2 x 4	2,5	0,8	1,5	13,7	4,95	295
2 x 6	3,0	0,8	1,6	15,0	3,30	370
2 x 10	4,0	1,0	1,8	18,6	1,91	590
2 x 16	5,0	0,8	2,0	22,5	1,21	905
2 x 25	6,2	1,2	2,2	27,0	0,780	1340
3 x 1,5	1,5	0,7	1,3	10,9	13,3	190
4 x 0,75	1,1	0,6	1,2	9,9	26,0	150
4 x 1,5	1,5	0,7	1,3	11,7	13,3	215
4 x 2,5	2,0	0,8	1,5	13,9	7,98	320
4 x 4	2,5	0,8	1,6	15,6	4,95	420
4 x 6	3,0	0,8	1,7	17,6	3,30	565
4 x 10	4,0	0,8	2,0	21,8	1,91	880
4 x 16	5,0	0,8	2,2	26,1	1,21	1330
4 x 25	6,2	1,2	2,6	32,0	0,780	1965
4 x 35	7,4	1,2	2,8	35,1	0,554	2490
4 x 50	8,9	1,4	3,2	42,1	0,386	3380
4 x 70	10,5	1,4	3,5	49,9	0,272	4535
4 x 95	12,2	1,6	3,5	51,1	0,206	4620
4 x 120	13,8	1,6	3,5	55,9	0,196	5780
4 x 150	15,4	1,8	3,8	63,8	0,129	7100
5 x 1	1,3	0,7	1,3	11,4	19,5	205
5 x 1,5	1,5	0,7	1,4	13,0	13,3	275
5 x 2,5	2,0	0,8	1,6	15,2	7,98	375
5 x 4	2,5	0,8	1,7	17,3	4,95	515
5 x 6	3,0	0,8	1,8	19,2	3,30	670
5 x 16	5,0	0,8	2,4	28,9	1,21	1630
5 x 35	7,4	1,2	2,8	35,1	0,554	3000
7 x 1	1,3	0,6	1,4	12,4	19,5	245
7 x 1,5	1,5	0,7	1,5	14,1	13,3	330
7 x 2,5	2,0	0,8	1,7	16,6	7,98	470
12 x 2,5	2,0	0,8	2,0	21,6	7,98	770
16 x 0,75	1,1	0,6	1,7	16,5	26,0	425
18 x 1	1,3	0,6	1,8	18,4	19,5	540
18 x 1,5	1,5	0,7	2,0	21,8	13,3	765
19 x 2,5	2,0	0,8	2,3	25,6	7,98	1105
25 x 0,75	1,1	0,6	1,9	20,4	26,0	620

TRATOS General Cables®

HSLH-JZ | HSLH-OZ cable

TRATOS HSLH-JZ TRATOS HSLH-OZ

Suitable for use as control cable in cases of particular fire safety requirements.

Can be laid static or mobile in dry, humid or wet environments. Not suited to high mechanical loading when laid mobile.

Cannot be laid outdoor in normal conditions. May be laid outdoor only in exceptional cases and with protection from solar radiation.

Reference Construction Products Regulation 305/2011 EU and Standard EN 50575:

The cable is suitable for the supply of electricity in buildings and other civil engineering works.

FEATURES AND PERFORMANCES

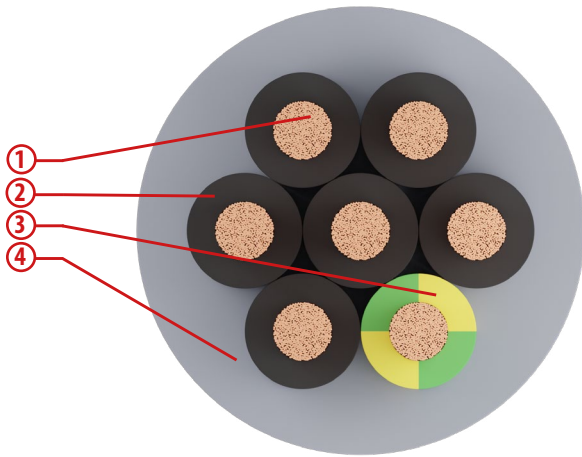

CONSTRUCTION

1. CLASS 5, FLEXIBLE, PLAIN COPPER WIRE
2. POLYOLEFIN LS0H
3. LS0H THERMOPLASTIC (OPTIONAL)
4. POLYOLEFIN LS0H

LS0H = Low Smoke Zero Halogen

Structure and electrical, physical, mechanical requirements: according to EN 50525-3-11

- **Fire propagation** EN 60332-3-24
- **Corrosive gases or halogens** EN 50267-2-2
- **Smoke density (transmittance)** EN 61034-2
- **Low Voltage Directive** 2014/35/EU
- **RoHS Directive** 2011/65/EU

Installation conditions

Minimum installation temperature	-5°C
Recommended min. bending radius	15 times the cable diameter
Recommended maximum tensile stress	50 N/mm ² of the cross-section of the copper

Functional characteristics

Rated voltage U ₀ /U	300/500 V
Max. operating temperature	70°C
Min. operating temperature	-20°C (without mechanical shocks)
Max. short circuit temperature	150°C

Marking

Tratos HSLH-JZ/OZ [form.] [year]

Colours

TWO-CORE	● ● (OZ)
THREE-CORE	● ● ● (JZ) ● ● ● (OZ)
FOUR-CORE	● ● ● ● (JZ) ● ● ● ● (OZ)
FIVE-CORE	● ● ● ● ● (JZ) ● ● ● ● ● (OZ)
MULTI-CORE (>5 cores)	● ● ● ● ● ● ● (JZ) ● ● ● ● ● ● ● (OZ)

HSLH-JZ numbered cores with conductor green/yellow
HSLH-OZ numbered cores without conductor green/yellow

Formation n° x mm ²	Approx. conductor Ø mm	Average insulation thickness mm	Average sheath thickness mm	Approx. external Ø mm	Max. electrical resistance at 20°C Ω/km	Approx. cable weight kg/km
5 x 0,5	1,0	0,45	0,7	5,8	39,0	56
7 x 0,5	1,0	0,45	0,7	6,5	39,0	72
12 x 0,5	1,0	0,45	0,9	8,3	39,0	115
18 x 0,5	1,0	0,45	0,9	10,2	39,0	175
25 x 0,5	1,0	0,45	1,0	11,7	39,0	230
34 x 0,5	1,0	0,45	1,3	12,9	39,0	375
42 x 0,5	1,0	0,45	1,3	16,6	39,0	425
50 x 0,5	1,0	0,45	1,4	17,9	26,0	500
2 x 0,75	1,2	0,45	0,6	5,2	26,0	40
3 x 0,75	1,2	0,45	0,6	5,5	26,0	48
4 x 0,75	1,2	0,45	0,7	5,9	26,0	59
5 x 0,75	1,2	0,45	0,7	6,7	26,0	72
7 x 0,75	1,2	0,45	0,8	7,3	26,0	93
12 x 0,75	1,2	0,45	0,9	9,6	26,0	155
18 x 0,75	1,2	0,45	1,1	11,7	26,0	235
25 x 0,75	1,2	0,45	1,2	13,3	26,0	310
34 x 0,75	1,2	0,45	1,4	15,5	26,0	415
42 x 0,75	1,2	0,45	1,5	18,5	26,0	560
50 x 0,75	1,2	0,45	1,6	19,9	26,0	650

Formation n° x mm ²	Approx. conductor Ø mm	Average insulation thickness mm	Average sheath thickness mm	Approx. external Ø mm	Max. electrical resistance at 20°C Ω/km	Approx. cable weight kg/km
4 x 1	1,3	0,45	0,7	6,5	19,5	74
5 x 1	1,3	0,45	0,7	7,1	19,5	91
7 x 1	1,3	0,45	0,8	7,9	19,5	115
12 x 1	1,3	0,45	1,0	10,1	19,5	190
18 x 1	1,3	0,45	1,1	12,6	19,5	290
25 x 1	1,3	0,45	1,3	14,2	19,5	380
34 x 1	1,3	0,45	1,4	16,7	19,5	515
42 x 1	1,3	0,45	1,5	19,0	19,5	640
50 x 1	1,3	0,45	1,6	21,2	13,3	800
3 x 1,5	1,5	0,50	0,7	6,5	13,3	77
4 x 1,5	1,5	0,50	0,8	7,1	13,3	95
5 x 1,5	1,5	0,50	0,8	8,0	13,3	120
7 x 1,5	1,5	0,50	0,9	8,6	13,3	150
12 x 1,5	1,5	0,50	1,1	11,3	13,3	255
18 x 1,5	1,5	0,50	1,3	14,0	13,3	385
25 x 1,5	1,5	0,50	1,5	16,0	13,3	515
34 x 1,5	1,5	0,50	1,6	18,6	13,3	690
42 x 1,5	1,5	0,50	1,8	22,5	13,3	900

TRATOS General Cables®

Formation	Approx. conductor Ø	Average insulation thickness	Average sheath thickness	Approx. external Ø	Max. electrical resistance at 20°C	Approx. cable weight
n° x mm ²	mm	mm	mm	mm	Ω/km	kg/km
2 x 2,5	2,0	0,55	0,8	7,8	7,98	92
3 x 2,5	2,0	0,55	0,8	8,4	7,98	120
4 x 2,5	2,0	0,55	0,9	9,3	7,98	150
5 x 2,5	2,0	0,55	0,9	10,3	7,98	185
7 x 2,5	2,0	0,55	1,0	11,4	7,98	240
12 x 2,5	2,0	0,55	1,3	15,2	7,98	400
18 x 2,5	2,0	0,55	1,5	18,1	7,98	600
25 x 2,5	2,0	0,55	1,7	21,6	7,98	800
35 x 2,5	2,0	0,55	2,0	24,0	7,98	1145
2 x 4	2,5	0,60	0,9	9,3	4,95	150
3 x 4	2,5	0,60	0,9	9,9	4,95	170
4 x 4	2,5	0,60	1,0	11,3	4,95	215
5 x 4	2,5	0,60	1,1	12,6	4,95	270
7 x 4	2,5	0,60	1,1	13,5	4,95	355
12 x 4	2,5	0,60	1,5	18,4	4,95	655
2 x 6	3,1	0,60	0,9	10,6	3,30	200
3 x 6	3,1	0,60	1,0	11,4	3,30	255
4 x 6	3,1	0,60	1,1	12,9	3,30	320
5 x 6	3,1	0,60	1,2	14,2	3,30	405
7 x 6	3,1	0,60	1,3	15,7	3,30	525
2 x 10	4,2	0,70	1,1	13,1	1,91	330
3 x 10	4,2	0,70	1,2	14,1	1,91	415
4 x 10	4,2	0,70	1,3	15,7	1,91	525
5 x 10	4,2	0,70	1,4	17,7	1,91	660
2 x 16	5,3	0,70	1,2	15,3	12,1	470
3 x 16	5,3	0,70	1,3	16,6	12,1	605
4 x 16	5,3	0,70	1,4	18,3	12,1	770
5 x 16	5,3	0,70	1,6	20,5	12,1	980

CABLES FOR A MOVING WORLD

TRATOS[®] ENERGY DNOs

Tratos Utility cables are designed and tested to meet relevant UK, European and International standards. Manufactured in state of the art manufacturing facilities, the company's purpose-built, in-house Fire, Chemical, Electrical and Physical testing facilities and laboratories deliver peace of mind to customers ensuring their choice of Utility cable products meet all statutory and regulatory requirements.



www.tratosgroup.com



TRATOS General Cables®

HSLH-JB | HSLH-OB cable

TRATOS HSLH-JB TRATOS HSLH-OB

Suitable for use as control cable in cases of particular fire safety requirements. Can be laid static or mobile in dry, humid or wet environments. Not suited to high mechanical loading when laid mobile. Cannot be laid outdoor in normal conditions. May be laid outdoor only in exceptional cases and with protection from solar radiation.

Reference Construction Products Regulation 305/2011 EU and Standard EN 50575:
The cable is suitable for the supply of electricity in buildings and other civil engineering works.

FEATURES AND PERFORMANCES

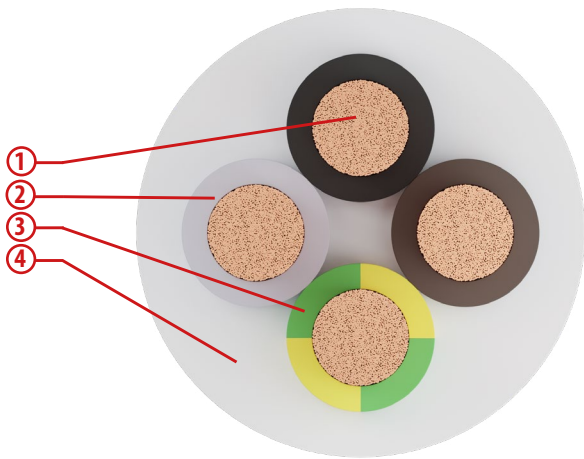

CONSTRUCTION

1. CLASS 5, FLEXIBLE, PLAIN COPPER WIRE
2. POLYOLEFIN LS0H
3. LS0H THERMOPLASTIC (OPTIONAL)
4. POLYOLEFIN LS0H

LS0H = Low Smoke Zero Halogen

Structure and electrical, physical, mechanical requirements: according to EN 50525-3-11

- Fire propagation EN 60332-3-24
- Corrosive gases or halogens EN 50267-2-2
- Smoke density (transmittance) EN 61034-2
- Low Voltage Directive 2014/35/EU
- RoHS Directive 2011/65/EU

Installation conditions

Minimum installation temperature	-5°C
Recommended min. bending radius	15 times the cable diameter
Recommended maximum tensile stress	50 N/mm ² of the cross-section of the copper







Functional characteristics

Rated voltage U ₀ /U	300/500 V
Max. operating temperature	70°C
Min. operating temperature	-20°C (without mechanical shocks)
Max. short circuit temperature	150°C

Marking

Tratos HSLH-JB/OB [form.] [year]

Colours

- TWO-CORE 
- THREE-CORE  or 
- FOUR-CORE  or 
- FIVE-CORE  or 

HSLH-JB coloured cores with conductor green/yellow
 HSLH-OB coloured cores without conductor green/yellow

Formation	Approx. conductor Ø	Average insulation thickness	Average sheath thickness	Approx. external Ø	Max. electrical resistance at 20°C	Approx. cable weight
n° x mm ²	mm	mm	mm	mm	Ω/km	kg/km
2 x 1,5	1,5	0,50	0,7	6,5	13,3	63
3 x 1,5	1,5	0,50	0,7	6,9	13,3	77
3 x 2,5	2,0	0,55	0,8	8,4	7,98	120
3 x 4	2,5	0,60	0,9	9,9	4,95	175
3 x 6	3,1	0,60	1,0	11,4	3,30	255
3 x 10	4,2	0,70	1,2	14,1	1,91	450
3 x 16	5,3	0,70	1,3	16,6	12,1	610
4 x 1	1,3	0,45	0,7	6,8	19,5	74
4 x 1,5	1,5	0,50	0,8	7,8	13,3	95
4 x 2,5	2,0	0,55	0,9	9,3	7,98	150
4 x 6	3,1	0,60	1,1	12,9	3,30	320
5 x 0,75	1,2	0,45	0,7	7,0	26,0	74
5 x 1	1,3	0,45	0,7	7,6	19,5	91
5 x 1,5	1,5	0,50	0,8	8,5	13,3	120
5 x 2,5	2,0	0,55	0,9	10,3	7,98	185
5 x 4	2,5	0,60	1,1	12,6	4,95	275
5 x 6	3,1	0,60	1,2	14,2	3,30	401
5 x 10	4,2	0,70	1,4	17,7	1,91	660
5 x 16	5,3	0,70	1,6	20,5	12,1	980

TRATOS General Cables®

HSLCH-JZ | HSLCH-OZ cable

TRATOS HSLCH-JZ TRATOS HSLCH-OZ

Suitable for use as control cable in cases of particular fire safety requirements. Can be laid static or mobile in dry, humid or wet environments. Not suited to high mechanical loading when laid mobile. Cannot be laid outdoor in normal conditions. May be laid outdoor only in exceptional cases and with protection from solar radiation. The screen offers protection against interference electromagnetic.

N.B. For applications not covered by Regulation EU 305/2011.

FEATURES AND PERFORMANCES

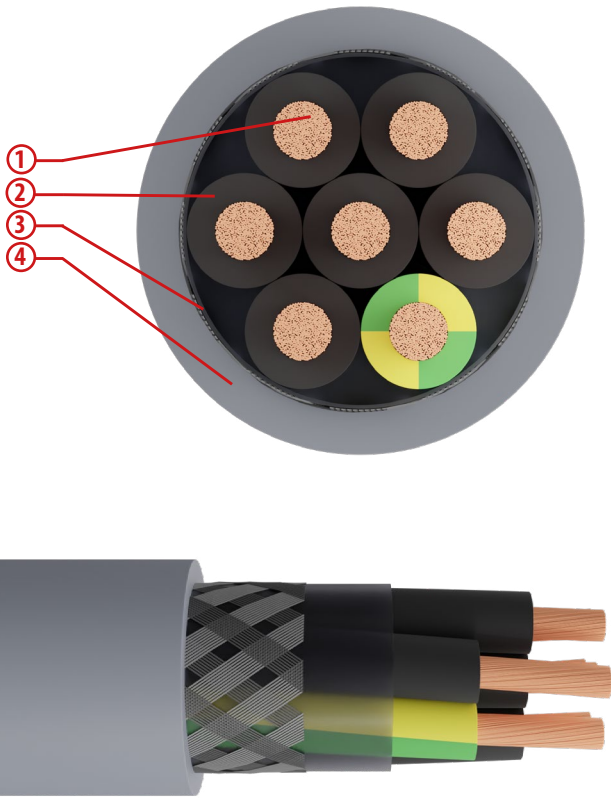

CONSTRUCTION

1. CLASS 5, FLEXIBLE, PLAIN COPPER WIRE
2. POLYOLEFIN LS0H
3. POLYESTER FOIL
4. POLYOLEFIN LS0H

LS0H = Low Smoke Zero Halogen

Structure and electrical, physical, mechanical requirements: according to EN 50525-3-11

- **Fire propagation** EN 60332-3-24
- **Flame propagation** EN 60332-1-2
- **Corrosive gases or halogens** EN 50267-2-2
- **Smoke density (transmittance)** EN 61034-2
- **Low Voltage Directive** 2014/35/EU
- **RoHS Directive** 2011/65/EU

Installation conditions

Minimum installation temperature	-5°C
Recommended min. bending radius	15 times the cable diameter
Recommended maximum tensile stress	50 N/mm ² of the cross-section of the copper

Functional characteristics

Rated voltage U ₀ /U	300/500 V
Max. operating temperature	70°C
Min. operating temperature	-20°C (without mechanical shocks)
Max. short circuit temperature	150°C

Marking

Tratos HSLCH-JZ/OZ [form.] [year]

Colours

TWO-CORE



THREE-CORE



FOUR-CORE



FIVE-CORE



MULTI-CORE (>5 cores)



HSLCH-JZ numbered cores with conductor green/yellow
HSLCH-OZ numbered cores without conductor green/yellow

Formation	Approx. conductor Ø	Average insulation thickness	Average sheath thickness	Approx. external Ø	Max. electrical resistance at 20°C	Approx. cable weight
n° x mm ²	mm	mm	mm	mm	Ω/km	kg/km
2 x 0,5	1,0	0,45	0,6	5,6	39,0	42
3 x 0,5	1,0	0,45	0,6	5,7	39,0	51
4 x 0,5	1,0	0,45	0,6	6,4	39,0	63
5 x 0,5	1,0	0,45	0,7	7,0	39,0	75
7 x 0,5	1,0	0,45	0,7	7,5	39,0	95
12 x 0,5	1,0	0,45	0,9	9,9	39,0	155
18 x 0,5	1,0	0,45	1,0	11,9	39,0	230
25 x 0,5	1,0	0,45	1,2	14,2	39,0	315
2 x 0,75	1,2	0,45	0,6	5,4	26,0	50
3 x 0,75	1,2	0,45	0,7	6,4	26,0	65
4 x 0,75	1,2	0,45	0,7	6,9	26,0	80
5 x 0,75	1,2	0,45	0,8	7,4	26,0	95
7 x 0,75	1,2	0,45	0,8	8,3	26,0	120
12 x 0,75	1,2	0,45	1,0	11,0	26,0	200
18 x 0,75	1,2	0,45	1,1	13,1	26,0	290
25 x 0,75	1,2	0,45	1,3	15,4	26,0	400
2 x 1	1,3	0,45	0,7	6,4	19,5	60
3 x 1	1,3	0,45	0,7	6,6	19,5	74
4 x 1	1,3	0,45	0,7	7,1	19,5	92
5 x 1	1,3	0,45	0,8	8,0	19,5	115
7 x 1	1,3	0,45	0,8	8,7	19,5	140
12 x 1	1,3	0,45	1,0	11,6	19,5	235
18 x 1	1,3	0,45	1,1	13,8	19,5	345
25 x 1	1,3	0,45	1,3	16,0	19,5	480
2 x 1,5	1,5	0,50	0,7	6,6	13,3	74
3 x 1,5	1,5	0,50	0,8	7,6	13,3	98
4 x 1,5	1,5	0,50	0,8	8,1	13,3	118
5 x 1,5	1,5	0,50	0,9	9,1	13,3	145
7 x 1,5	1,5	0,50	0,9	9,9	13,3	185
12 x 1,5	1,5	0,50	1,1	13,1	13,3	315
18 x 1,5	1,5	0,50	1,3	15,9	13,3	475
25 x 1,5	1,5	0,50	1,5	18,7	13,3	650
2 x 2,5	2,0	0,55	0,8	8,3	7,98	105
3 x 2,5	2,0	0,55	0,8	8,7	7,98	137
4 x 2,5	2,0	0,55	0,9	9,9	7,98	175
5 x 2,5	2,0	0,55	1,0	10,9	7,98	215
7 x 2,5	2,0	0,55	1,0	12,0	7,98	280
12 x 2,5	2,0	0,55	1,3	15,8	7,98	480

TRATOS General Cables®

Formation n° x mm ²	Approx. conductor Ø mm	Average insulation thickness mm	Average sheath thickness mm	Approx. external Ø mm	Max. electrical resistance at 20°C Ω/km	Approx. cable weight kg/km
2 x 4	2,5	0,60	0,9	10,0	4,95	135
3 x 4	2,5	0,60	1,0	10,7	4,95	190
4 x 4	2,5	0,60	1,0	11,8	4,95	230
5 x 4	2,5	0,60	1,1	13,1	4,95	300
7 x 4	2,5	0,60	1,2	14,4	4,95	380
2 x 6	3,1	0,60	1,0	11,2	3,30	190
3 x 6	3,1	0,60	1,0	12,2	3,30	260
4 x 6	3,1	0,60	1,1	13,4	3,30	340
5 x 6	3,1	0,60	1,2	14,7	3,30	430
7 x 6	3,1	0,60	1,3	16,6	3,30	580
2 x 10	4,2	0,70	1,1	13,5	1,91	310
3 x 10	4,2	0,70	1,2	14,8	1,91	410
4 x 10	4,2	0,70	1,3	16,6	1,91	560
5 x 10	4,2	0,70	1,4	18,6	1,91	730
2 x 16	5,3	0,70	1,3	15,7	12,1	465
3 x 16	5,3	0,70	1,4	17,6	12,1	640
4 x 16	5,3	0,70	1,5	19,2	12,1	800
5 x 16	5,3	0,70	1,6	21,5	12,1	1015

CABLES FOR A MOVING WORLD

TRATOS[®] ENERGY DNOs

Tratos Utility cables are designed and tested to meet relevant UK, European and International standards. Manufactured in state of the art manufacturing facilities, the company's purpose-built, in-house Fire, Chemical, Electrical and Physical testing facilities and laboratories deliver peace of mind to customers ensuring their choice of Utility cable products meet all statutory and regulatory requirements.



www.tratosgroup.com



2XSLCYK-J cable

TRATOS 2XSLCYK-J TRATOS 2XSLCYK-J PLUS

Particularly recommended for motor power supply with frequency converters, when EMC performance is required. For dry, humid and wet conditions. Suitable for indoor static laying. Suitable for outdoor static laying.

Reference Construction Products Regulation 305/2011 EU and Standard EN 50575:
The cable is suitable for the supply of electricity in buildings and other civil engineering works.

FEATURES AND PERFORMANCES

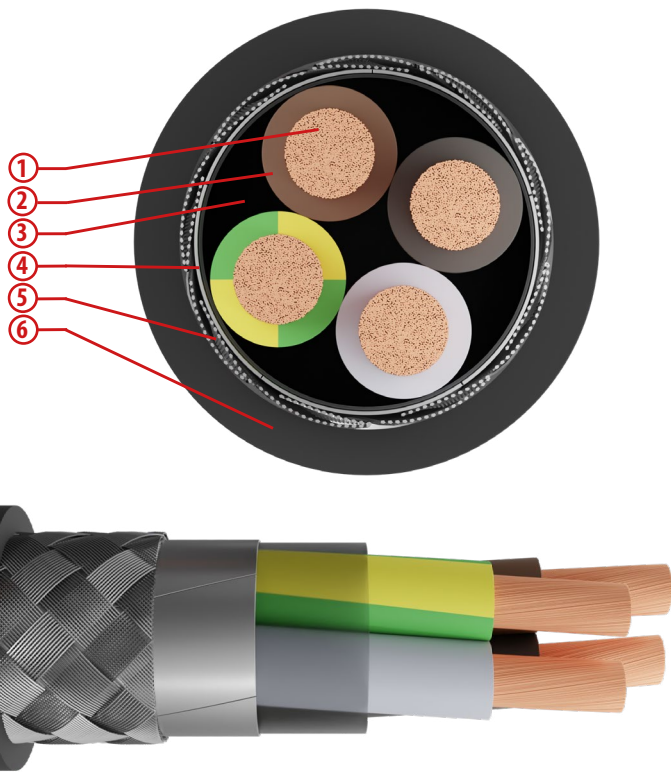

CONSTRUCTION

1. CLASS 5, FLEXIBLE, PLAIN COPPER WIRE
2. CROSS-LINKED POLYETHYLENE XLPE
3. POLYESTER FOIL
4. ALUMINIUM POLYESTER FOIL
5. TINNED COPPER BRAID (COVERAGE 75 ± 5%)
6. PVC COMPOUND

Structure and electrical, physical, mechanical requirements: Ref. to IEC 60502-1

- Oil, acids and bases resistance CEI 20-34
- Low Voltage Directive 2014/35/EU
- RoHS Directive 2011/65/EU

Functional characteristics

Rated voltage U ₀ /U	0,6/1 kV
Max. operating temperature	90°C
Min. operating temperature	-40°C (without mechanical shocks)
Max. short circuit temperature	150°C

Installation conditions

Minimum installation temperature	-5 °C
Recommended min. bending radius	8 times the cable diameter
Recommended maximum tensile stress	50 N/mm ² of the cross-section of the copper

Special features

Good UV resistance.
Good resistance to oils and industrial greases.
Good resistance to low temperatures.

Cable Marking

Tratos 2XSLCYK-J 0,6/1 kV [year] [traceability] [metric]
Tratos 2XSLCYK-J 3-PLUS 0,6/1 kV [year] [traceability] [metric]

Colours

FOUR-CORE

SYMMETRIC VERSION



2XSLCYK-J

Formation	Approx. conductor \emptyset	Average insulation thickness	Average sheath thickness	Approx. external \emptyset	Max. electrical resistance at 20°C	Capacity at 50Hz		Approx. cable weight	Current rating in free air at 30°C
						core/core $\mu\text{F}/\text{km}$	core/screen $\mu\text{F}/\text{km}$		
$n^\circ \times \text{mm}^2$	mm	mm	mm	mm	Ω/km			kg/km	A
4G1,5	1,5	0,7	1,8	11,1	13,3	70	110	180	23
4G2,5	2,0	0,8	1,8	12,6	7,98	80	130	225	32
4G4	2,5	0,8	1,8	13,8	4,95	90	150	310	42
4G6	3,0	0,8	1,8	15,2	3,30	90	150	405	54
4G10	4,0	1,0	1,8	18,7	1,91	120	200	650	75
4G16	5,0	1,0	1,8	21,4	1,21	140	230	870	100
4G25	6,2	1,2	1,8	25,2	0,780	120	211	1275	127
4G35	7,4	1,2	1,8	28,1	0,554	150	260	1750	158
4G50	8,9	1,4	2,0	33,1	0,386	190	320	2415	192
4G70	10,5	1,4	2,1	37,4	0,272	190	320	3220	246
4G95	12,2	1,6	2,3	42,4	0,206	250	410	4225	298
4G120	13,8	1,6	2,4	47,3	0,161	-	-	5295	346
4G150	15,4	1,8	2,6	52,4	0,129	-	-	6590	399
4G185	16,9	2,0	2,7	57,2	0,106	-	-	7990	456
4G240	19,5	2,0	2,9	63,7	0,0801	-	-	10180	538

2XSLCYK-J 3-PLUS

Formation	Approx. conductor \emptyset	Average insulation thickness	Average sheath thickness	Approx. external \emptyset	Max. electrical resistance at 20°C	Approx. cable weight	Current rating in free air at 30°C
$n^\circ \times \text{mm}^2$	mm	mm	mm	mm	Ω/km	kg/km	A
3 x 10 + 3G1,5	4,0/1,5	1,0/0,7	1,8	16,8	1,91/13,3	490	75
3 x 16 + 3G2,5	5,0/2,0	1,0/0,8	1,8	19,3	1,21/7,98	745	100
3 x 25 + 3G4	6,2/2,5	1,2/0,8	1,8	22,6	0,780/4,95	1075	127
3 x 35 + 3G6	7,4/3,0	1,2/0,8	1,8	25,4	0,554/3,30	1420	158
3 x 50 + 3G10	8,9/4,0	1,4/1,0	1,9	29,9	0,386/1,91	2040	192
3 x 70 + 3G10	10,5/4,0	1,4/1,0	2,0	33,8	0,272/1,91	2650	246
3 x 95 + 3G16	12,2/5,0	1,6/1,2	2,1	37,9	0,206/1,21	3470	298
3 x 120 + 3G16	13,8/5,0	1,6/1,2	2,2	42,5	0,161/1,21	4275	346
3 x 150 + 3G25	15,4/6,2	1,8/1,2	2,4	47,1	0,129/0,780	5430	399
3 x 185 + 3G35	16,9/7,4	2,0/1,2	2,5	51,4	0,106/0,554	6696	456
3 x 240 + 3G50	19,5/8,9	2,0/1,2	2,7	57,2	0,801/0,386	8571	538

TRATOS General Cables®

2YSLCY(K)-J | 2YSLCY(K)-J PLUS cable

TRATOS 2YSLCY(K)-J TRATOS 2YSLCY(K)-J PLUS

Particularly recommended for motor power supply with frequency converters, when EMC performance is required. For dry, humid and wet conditions. Suitable for indoor static laying. Suitable for outdoor static laying (only 2YSLCYK-J).

Reference Construction Products Regulation 305/2011 EU and Standard EN 50575:

The cable is suitable for the supply of electricity in buildings and other civil engineering works.

FEATURES AND PERFORMANCES

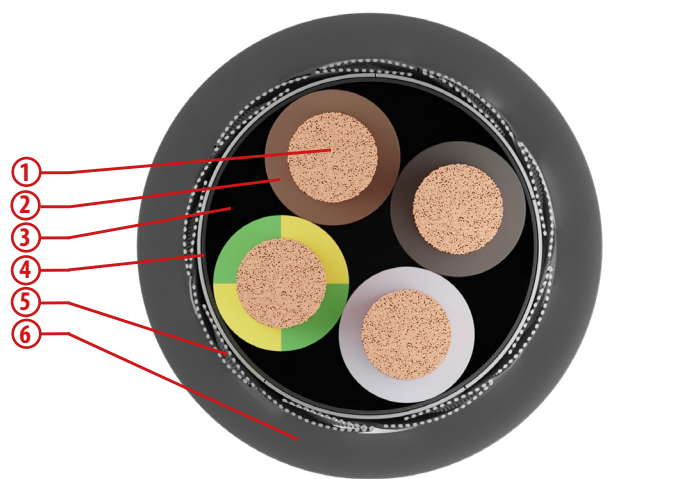

CONSTRUCTION

1. CLASS 5, FLEXIBLE, PLAIN COPPER WIRE
2. POLYETHYLENE PE
3. POLYESTER FOIL
4. ALUMINIUM POLYESTER FOIL
5. TINNED COPPER BRAID (COVERAGE 75 ± 5%)
6. PVC COMPOUND

Structure and electrical, physical, mechanical requirements: Ref. to IEC 60502-1

- Oil, acids and bases resistance CEI 20-34
- Low Voltage Directive 2014/35/EU
- RoHS Directive 2011/65/EU

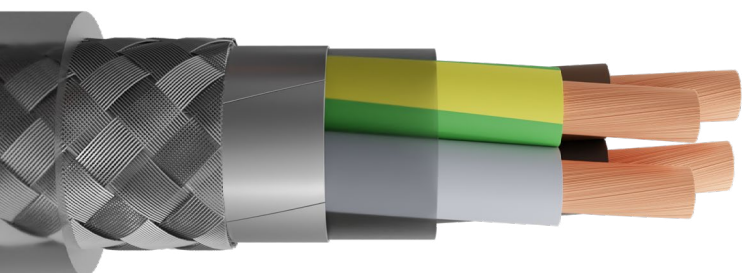

Special features

Good UV resistance (only 2YSLCYK-J)
Good resistance to oils and industrial greases.
Good resistance to low temperatures.

Cable Marking

Tratos 2YSLCY(K)-J [form.] 0,6/1 kV [year] [traceability] [metric]
Tratos 2YSLCY(K)-J 3-PLUS [form.] 0,6/1 kV [year] [traceability] [metric]

Colours

FOUR-CORE



SYMMETRIC VERSION



Installation conditions	
Minimum installation temperature	-5 °C
Recommended min. bending radius	8 times the cable diameter
Recommended maximum tensile stress	50 N/mm ² of the cross-section of the copper

Functional characteristics	
Rated voltage U ₀ /U	0,6/1 kV
Max. operating temperature	70°C
Min. operating temperature	-40°C (without mechanical shocks)
Max. short circuit temperature	150°C

2YSLCYK-J / 2YSLCY-J

Formation	Approx. conductor \emptyset	Average insulation thickness	Average sheath thickness	Approx. external \emptyset	Max. electrical resistance at 20°C	Capacity at 50Hz		Approx. cable weight	Current rating in free air at 30°C
						core/core $\mu\text{F}/\text{km}$	core/screen $\mu\text{F}/\text{km}$		
n° x mm ²	mm	mm	mm	mm	Ω/km			kg/km	A
4G1,5	1,5	0,7	1,8	11,1	13,3	70	110	180	18,5
4G2,5	2,0	0,8	1,8	12,6	7,98	80	130	225	25
4G4	2,5	0,8	1,8	13,8	4,95	90	150	310	34
4G6	3,0	0,8	1,8	15,2	3,30	90	150	405	43
4G10	4,0	1,0	1,8	18,7	1,91	120	200	650	60
4G16	5,0	1,0	1,8	21,4	1,21	140	230	870	80
4G25	6,2	1,2	1,8	25,2	0,780	120	211	1275	101
4G35	7,4	1,2	1,8	28,1	0,554	150	260	1750	126
4G50	8,9	1,4	2,0	33,1	0,386	190	320	2415	153
4G70	10,5	1,4	2,1	37,4	0,272	190	320	3220	196
4G95	12,2	1,6	2,3	42,4	0,206	250	410	4225	238
4G120	13,8	1,6	2,4	47,3	0,161	-	-	5295	276
4G150	15,4	1,8	2,6	52,4	0,129	-	-	6590	319
4G185	16,9	2,0	2,7	57,2	0,106	-	-	7990	364
4G240 *	19,5	2,0	2,9	63,7	0,0801	-	-	10180	430

* Only for 2YSLCYK-J

2YSLCYK-J 3-PLUS / 2YSLCY-J 3-PLUS

Formation	Approx. conductor \emptyset	Average insulation thickness	Average sheath thickness	Approx. external \emptyset	Max. electrical resistance at 20°C	Approx. cable weight	Current rating in free air at 30°C
n° x mm ²	mm	mm	mm	mm	Ω/km	kg/km	A
3 x 10 + 3G1,5	4,0/1,5	1,0/0,7	1,8	16,8	1,91/13,3	490	60
3 x 16 + 3G2,5	5,0/2,0	1,0/0,8	1,8	19,3	1,21/7,98	745	80
3 x 25 + 3G4	6,2/2,5	1,2/0,8	1,8	22,6	0,780/4,95	1075	101
3 x 35 + 3G6	7,4/3,0	1,2/0,8	1,8	25,4	0,554/3,30	1420	126
3 x 50 + 3G10	8,9/4,0	1,4/1,0	1,9	29,9	0,386/1,91	2040	153
3 x 70 + 3G10	10,5/4,0	1,4/1,0	2,0	33,8	0,272/1,91	2650	196
3 x 95 + 3G16	12,2/5,0	1,6/1,2	2,1	37,9	0,206/1,21	3470	238
3 x 120 + 3G16	13,8/5,0	1,6/1,2	2,2	42,5	0,161/1,21	4275	276
3 x 150 + 3G25	15,4/6,2	1,8/1,2	2,4	47,1	0,129/0,780	5430	319
3 x 185 + 3G35	16,9/7,4	2,0/1,2	2,5	51,4	0,106/0,554	6696	364
3 x 240 + 3G50 *	19,5/8,9	2,0/1,2	2,7	57,2	0,0801/0,386	8571	430

* Only for 2YSLCYK-J 3-PLUS

TRATOS General Cables®

YCY cable

TRATOS YCY

Suitable for connecting telephone and signalling systems. For static installations indoor in dry or humid environments. Can be laid outdoor only if adequately protected from solar radiation. The screen offers protection from electromagnetic interference.

Reference Construction Products Regulation 305/2011 EU and Standard EN 50575:

The cable is suitable for the supply of electricity in buildings and other civil engineering works.

FEATURES AND PERFORMANCES

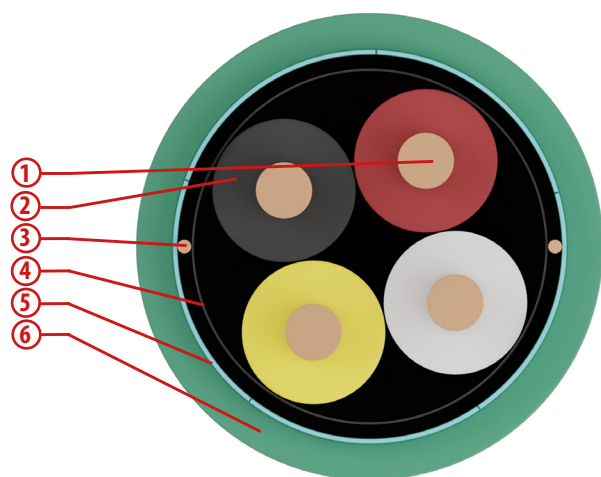

CONSTRUCTION

1. CLASS 1, SOLID, PLAIN COPPER
2. PVC
3. ONE STAR QUAD
4. POLYESTER FOIL
5. ALUMINUM POLYESTER FOIL AND PLAIN COPPER DRAIN-WIRE
6. PVC

Structure and electrical, physical, mechanical requirements: EIB recognized

- Low Voltage Directive 2014/35/EU
- RoHS Directive 2011/65/EU

Cable Marking

Tratos YCY [form.] Eca [year]

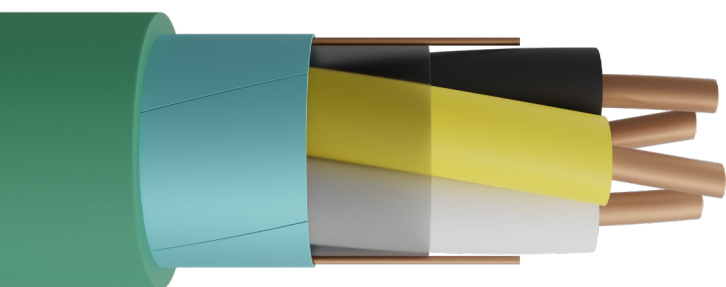

Installation conditions	
Minimum installation temperature	-5 °C
Recommended min. bending radius	16 times the cable diameter
Recommended maximum tensile stress	50 N/mm ² of the cross-section of the copper

Functional characteristics	
Rated voltage	300 V
Max. operating temperature	70°C
Max. short circuit temperature	160°C
Insulation resistance at 20°C	min. 100 MΩkm
Mutual capacity (800 Hz)	max. 100 nF/km
Capacity unbalance (800 Hz)	max. 300 pF/100 m
Inductance (800 Hz)	0,78 mH/km

	Frequency	
	100 kHz	1 MHz
Characteristic impedance (typical) Ω	105	90
Attenuation (typical) dB/Km	5,5	35,0

Formation	Approx. conductor Ø	Average insulation thickness	Average sheath thickness	Approx. external Ø	Approx. cable weight	Max. electrical resistance at 20°C	Approx. caloric load
n° x mm ²	mm	mm	mm	mm	kg/km	Ω/km	kWh/m
2 x 2 x 0,8	0,8	0,3	1,0	6,6	58	73,2	0,21

HCH cable

TRATOS HCH

For connection of telephone systems, signalling when safety requirements limit the emission of toxic and corrosive gases. For fixed installations indoor in normal and wet environments. Can be laid outdoor only if adequately protected from solar radiation. The screen offers protection from electromagnetic interference.

Reference Construction Products Regulation 305/2011 EU and Standard EN 50575:

The cable is suitable for the supply of electricity in buildings and other civil engineering works.

FEATURES AND PERFORMANCES

CONSTRUCTION

1. CLASS 1, SOLID, PLAIN COPPER
2. LSOH THERMOPLASTIC
3. ONE STAR QUAD
4. POLYESTER FOIL
5. ALUMINUM POLYESTER FOIL AND PLAIN COPPER DRAIN-WIRE
6. LSOH THERMOPLASTIC

Structure and electrical, physical, mechanical requirements: EN 50267-2-1 EN 50267-2-2

- **Smoke density (transmittance)** EN 61034-2
- **Low Voltage Directive** 2014/35/EU
- **RoHS Directive** 2011/65/EU

Cable Marking

Tratos HCH BUS [form.] Eca [year]

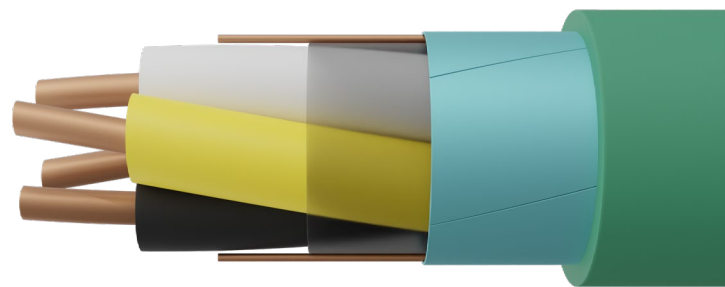
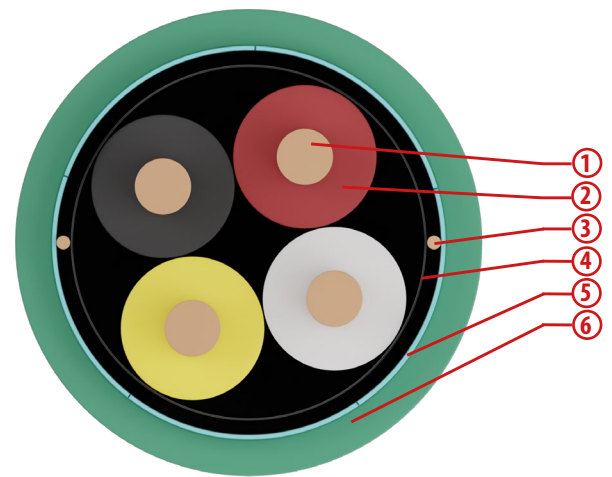

Installation conditions	
Minimum installation temperature	-5 °C
Recommended min. bending radius	16 times the cable diameter
Recommended maximum tensile stress	50 N/mm ² of the cross-section of the copper

Functional characteristics	
Rated voltage	300 V
Max. operating temperature	70°C
Max. short circuit temperature	160°C
Insulation resistance at 20°C	min. 100 MΩkm
Mutual capacity (800 Hz)	max. 100 nF/km
Capacity unbalance (800 Hz)	max. 300 pF/100 m
Inductance (800 Hz)	0,78 mH/km

	Frequency	
	100 kHz	1 MHz
Characteristic impedance (typical) Ω	110	95
Attenuation (typical) dB/Km	5,0	30,0

Formation	Approx. conductor Ø	Average insulation thickness	Average sheath thickness	Approx. external Ø	Approx. cable weight	Max. electrical resistance at 20°C	Approx. caloric load
n° x mm ²	mm	mm	mm	mm	kg/km	Ω/km	kWh/m
2 x 2 x 0,8	0,8	0,3	1,0	6,6	56	73,2	0,16

J-Y(St)Y Lg cable

TRATOS J-Y(St)Y Lg

Suitable for telecommunications and data processing systems, for connecting public and private telephone equipment. For static installations in dry or humid environments, and on the outside walls of buildings, both on or under plaster. The screen offers protection from electromagnetic interference. Can be used in static installations down to -20°C.

Reference Construction Products Regulation 305/2011 EU and Standard EN 50575:

The cable is suitable for the supply of electricity in buildings and other civil engineering works.

FEATURES AND PERFORMANCES

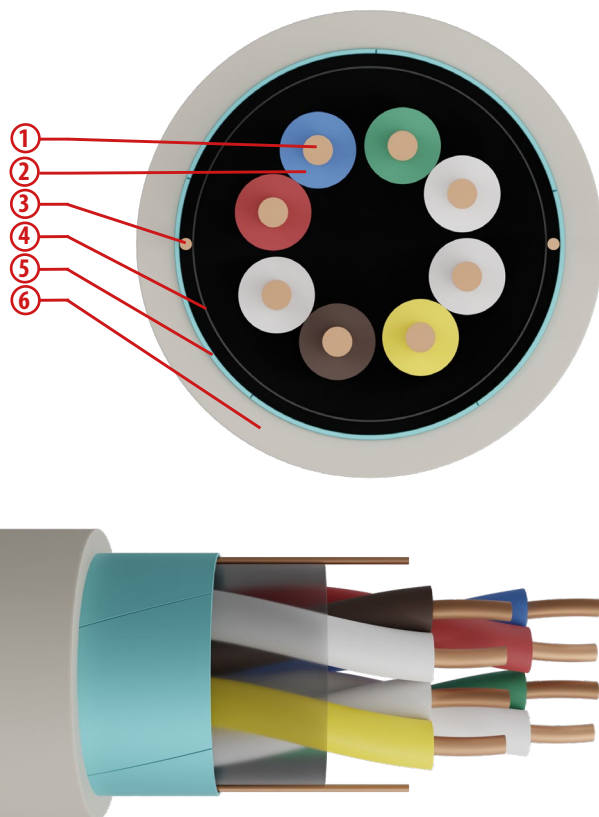

CONSTRUCTION

1. CLASS 1, SOLID, PLAIN COPPER
2. PVC
3. ONE STAR QUAD, OTHER STRANDED IN PAIRS
4. POLYESTER FOIL
5. ALUMINUM POLYESTER FOIL AND PLAIN COPPER DRAIN-WIRE
6. PVC

Structure and electrical, physical, mechanical requirements: VDE 0815

- **Low Voltage Directive** 2014/35/EU
- **RoHS Directive** 2011/65/EU

Installation conditions

Minimum installation temperature	-5°C
Recommended min. bending radius	16 times the cable diameter
Recommended maximum tensile stress	50 N/mm ² of the cross-section of the copper

Functional characteristics

Rated voltage	300 V
Insulation resistance at 20°C	min. 100 MΩkm
Mutual capacity (800 Hz)	max. 100 nF/km
Capacity unbalance (800 Hz)	max. 300 pF/100 m

J-Y(St)Y

Formation	Approx. conductor \emptyset	Average insulation thickness	Average sheath thickness	Approx. external \emptyset	Max. electrical resistance at 20°C	Approx. cable weight
n° x mm ²	mm	mm	mm	mm	Ω /km	kg/km
2 x 2 x 0,6	0,6	0,15	1,0	4,8	130	32
4 x 2 x 0,6	0,6	0,15	1,0	6,7	130	53
6 x 2 x 0,6	0,6	0,15	1,0	7,5	130	69
8 x 2 x 0,6	0,6	0,15	1,0	7,9	130	84
10 x 2 x 0,6	0,6	0,15	1,0	8,4	130	100
16 x 2 x 0,6	0,6	0,15	1,0	9,3	130	150
20 x 2 x 0,6	0,6	0,15	1,0	10,8	130	180
24 x 2 x 0,6	0,6	0,15	1,0	11,6	130	210
30 x 2 x 0,6	0,6	0,15	1,2	13,2	130	250
40 x 2 x 0,6	0,6	0,15	1,2	14,5	130	330
50 x 2 x 0,6	0,6	0,15	1,2	16,0	130	395
60 x 2 x 0,6	0,6	0,15	1,2	17,3	130	475
80 x 2 x 0,6	0,6	0,15	1,4	19,5	130	630
100 x 2 x 0,6	0,6	0,15	1,4	21,7	130	770
2 x 2 x 0,8	0,8	0,3	1,0	6,6	73,2	57
4 x 2 x 0,8	0,8	0,3	1,0	8,6	73,2	85
6 x 2 x 0,8	0,8	0,3	1,0	9,8	73,2	120
8 x 2 x 0,8	0,8	0,3	1,0	10,6	73,2	145
10 x 2 x 0,8	0,8	0,3	1,0	11,7	73,2	175
16 x 2 x 0,8	0,8	0,3	1,2	13,9	73,2	275
20 x 2 x 0,8	0,8	0,3	1,2	15,7	73,2	340
24 x 2 x 0,8	0,8	0,3	1,2	16,6	73,2	390
30 x 2 x 0,8	0,8	0,3	1,4	18,3	73,2	375
40 x 2 x 0,8	0,8	0,3	1,4	20,6	73,2	630
50 x 2 x 0,8	0,8	0,3	1,4	23,0	73,2	770
60 x 2 x 0,8	0,8	0,3	1,6	25,1	73,2	920

J-Y(St)Y Lg Brandmeldekabel cable

TRATOS J-Y(St)Y Lg Brandmeldekabel

Suitable for telecommunications and data processing systems, for connecting public and private telephone equipment. For static installations in dry or humid environments, and on the outside walls of buildings, both on or under plaster. The screen offers protection from electromagnetic interference. Can be used in static installations down to -20°C.

Reference Construction Products Regulation 305/2011 EU and Standard EN 50575:

The cable is suitable for the supply of electricity in buildings and other civil engineering works.

FEATURES AND PERFORMANCES

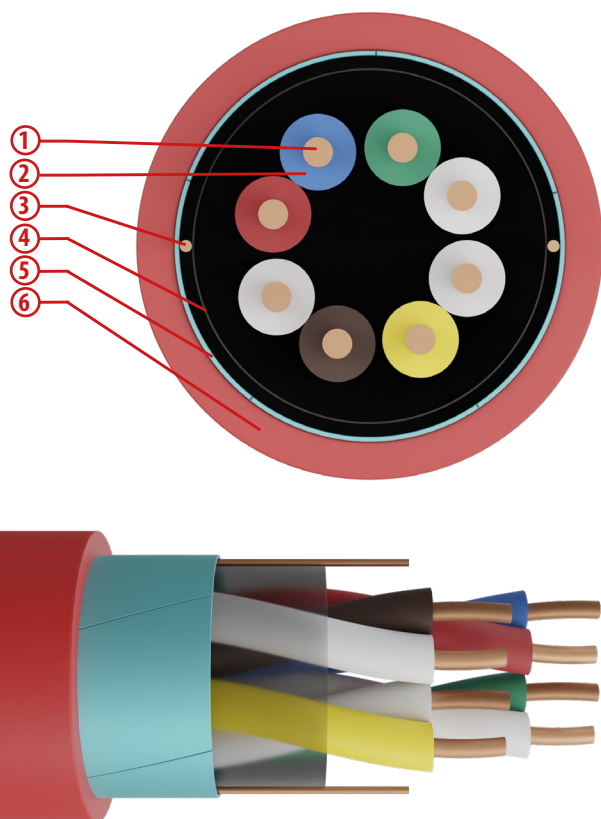

CONSTRUCTION

1. CLASS 1, SOLID, PLAIN COPPER
2. PVC
3. ONE STAR QUAD, OTHER STRANDED IN PAIRS
4. POLYESTER FOIL
5. ALUMINUM POLYESTER FOIL AND PLAIN COPPER DRAIN-WIRE
6. PVC

Structure and electrical, physical, mechanical requirements: VDE 0815

- **Low Voltage Directive** 2014/35/EU
- **RoHS Directive** 2011/65/EU

Installation conditions

Minimum installation temperature	-5°C
Recommended min. bending radius	16 times the cable diameter
Recommended maximum tensile stress	50 N/mm ² of the cross-section of the copper

Functional characteristics

Rated voltage	300 V
Insulation resistance at 20°C	min. 100 MΩkm
Mutual capacity (800 Hz)	max. 100 nF/km
Capacity unbalance (800 Hz)	max. 300 pF/100 m

J-Y(St)Y Lg BMK

Formation	Approx. conductor \emptyset	Average insulation thickness	Average sheath thickness	Approx. external \emptyset	Max. electrical resistance at 20°C	Approx. cable weight
n° x mm ²	mm	mm	mm	mm	Ω /km	kg/km
1 x 2 x 0,8	0,8	0,3	1,0	5,3	73,2	35
2 x 2 x 0,8	0,8	0,3	1,0	6,6	73,2	57
4 x 2 x 0,8	0,8	0,3	1,0	8,6	73,2	85
6 x 2 x 0,8	0,8	0,3	1,0	9,8	73,2	120
8 x 2 x 0,8	0,8	0,3	1,0	10,6	73,2	145
10 x 2 x 0,8	0,8	0,3	1,0	11,7	73,2	175
16 x 2 x 0,8	0,8	0,3	1,2	13,9	73,2	275
20 x 2 x 0,8	0,8	0,3	1,2	15,7	73,2	340
24 x 2 x 0,8	0,8	0,3	1,2	16,6	73,2	390
30 x 2 x 0,8	0,8	0,3	1,4	18,3	73,2	375
40 x 2 x 0,8	0,8	0,3	1,4	20,6	73,2	630
50 x 2 x 0,8	0,8	0,3	1,4	23,0	73,2	770
60 x 2 x 0,8	0,8	0,3	1,6	25,1	73,2	920

J-H(St)H Bd cable

TRATOS J-H(St)H Bd

For telephone, measuring, and technological control systems. For internal telecommunications in fire risk areas when safety requirements limit toxic and corrosive gases emissions. Suitable for static installations in humid or dry environments and under plaster. Can be used in static installations down to -30°C. Outdoor use is only permitted if adequately protected from solar radiation. The screen offers protection from electromagnetic interference.

N.B. For applications not covered by Regulation EU 305/2011.

FEATURES AND PERFORMANCES

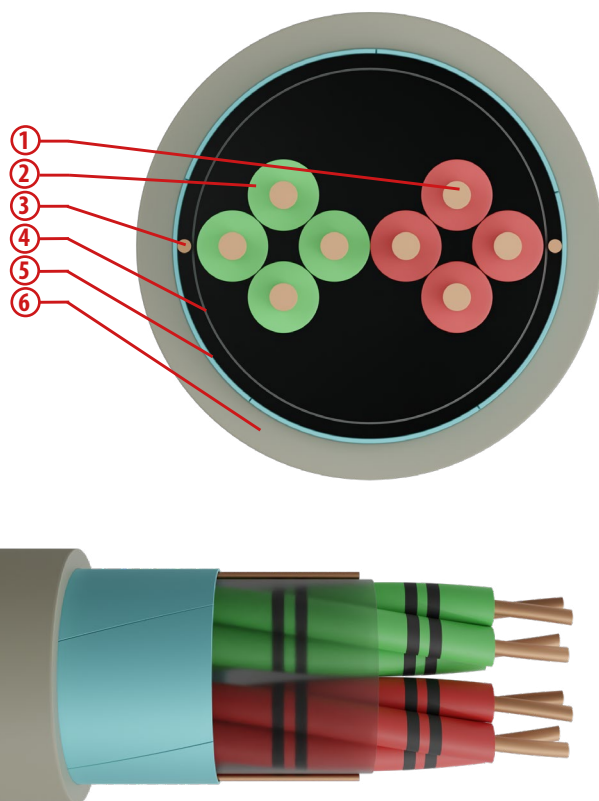

CONSTRUCTION

1. CLASS 1, SOLID, PLAIN COPPER
2. POLYOLEFIN LS0H
3. STAR QUADS
4. POLYESTER FOIL
5. ALUMINUM POLYESTER FOIL AND PLAIN COPPER DRAIN-WIRE
6. POLYOLEFIN LS0H

Structure and electrical, physical, mechanical requirements: VDE 0815

- **Low Voltage Directive** 2014/35/EU
- **RoHS Directive** 2011/65/EU

Installation conditions

Minimum installation temperature	-20°C
Recommended min. bending radius	16 times the cable diameter
Recommended maximum tensile stress	50 N/mm ² of the cross-section of the copper

Functional characteristics

Rated voltage	300 V
Insulation resistance at 20°C	min. 100 MΩkm
Mutual capacity (800 Hz)	max. 120 nF/km
Capacity unbalance K1 (800 Hz)	max. 300 pF/100 m
Capacity unbalance K9-12(800 Hz)	max 100 pF/100 m

Formation	Approx. conductor \emptyset	Average insulation thickness	Average sheath thickness	Approx. external \emptyset	Max. electrical resistance at 20°C	Approx. cable weight
n° x mm ²	mm	mm	mm	mm	Ω /km	kg/km
2 x 2 x 0,6	0,6	0,25	1,4	6,2	130	50
4 x 2 x 0,6	0,6	0,25	1,4	8,0	130	80
6 x 2 x 0,6	0,6	0,25	1,4	9,1	130	100
10 x 2 x 0,6	0,6	0,25	1,4	10,5	130	140
20 x 2 x 0,6	0,6	0,25	1,4	14,1	130	250
30 x 2 x 0,6	0,6	0,25	1,6	16,7	130	360
40 x 2 x 0,6	0,6	0,25	1,6	19,2	130	450
50 x 2 x 0,6	0,6	0,25	1,6	21,7	130	600
60 x 2 x 0,6	0,6	0,25	1,8	22,7	130	680
80 x 2 x 0,6	0,6	0,25	2,0	25,6	130	855
100 x 2 x 0,6	0,6	0,25	2,0	27,5	130	1060
2 x 2 x 0,8	0,8	0,3	1,4	6,9	73,2	75
4 x 2 x 0,8	0,8	0,3	1,4	9,0	73,2	115
6 x 2 x 0,8	0,8	0,3	1,4	10,3	73,2	140
10 x 2 x 0,8	0,8	0,3	1,4	12,2	73,2	210
20 x 2 x 0,8	0,8	0,3	1,4	16,4	73,2	375
30 x 2 x 0,8	0,8	0,3	1,6	19,8	73,2	550
40 x 2 x 0,8	0,8	0,3	1,8	23,0	73,2	715
50 x 2 x 0,8	0,8	0,3	2,0	26,6	73,2	985
60 x 2 x 0,8	0,8	0,3	2,0	27,6	73,2	1060
80 x 2 x 0,8	0,8	0,3	2,0	30,1	73,2	1345
100 x 2 x 0,8	0,8	0,3	2,0	32,6	73,2	1655

J-H(St)H Bd Brandmeldekabel cable

TRATOS J-H(St)H Bd Brandmeldekabel

For telephone, measuring, and technological control systems. For internal telecommunications in fire risk areas when safety requirements limit toxic and corrosive gases emissions. Suitable for static installations in humid or dry environments and under plaster. Can be used in static installations down to -30°C. Outdoor use is only permitted if adequately protected from solar radiation. The screen offers protection from electromagnetic interference.

N.B. For applications not covered by Regulation EU 305/2011.

FEATURES AND PERFORMANCES

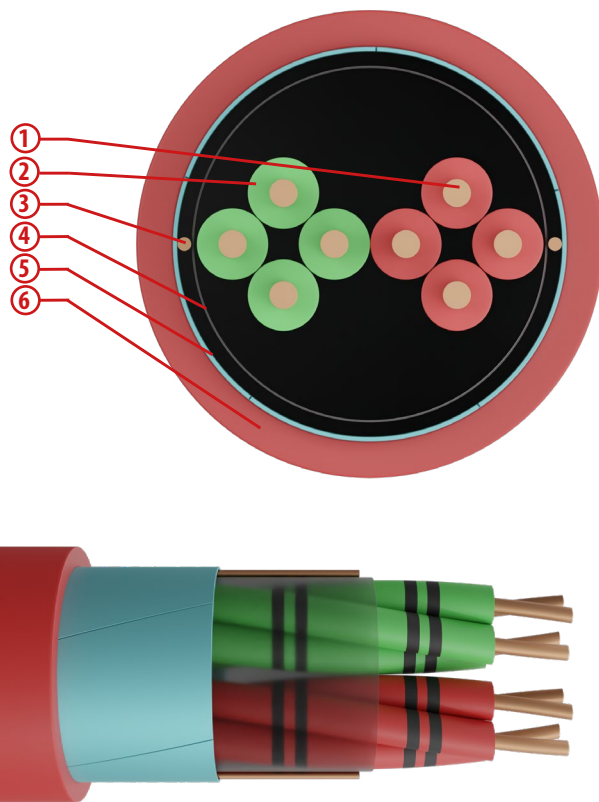

CONSTRUCTION

1. CLASS 1, SOLID, PLAIN COPPER
2. POLYOLEFIN LS0H
3. STAR QUADS FOR CABLES HAVING MORE THAN 2 CONDUCTORS
4. POLYESTER FOIL
5. ALUMINUM POLYESTER FOIL AND PLAIN COPPER DRAIN-WIRE
6. POLYOLEFIN LS0H

Structure and electrical, physical, mechanical requirements: ref. to DIN VDE 0815 IEC 60332-3-24

- Corrosive gases or halogens EN 50267-2-1
EN 50267-2-2
- Smoke density (transmittance) EN 61034-2
- Low Voltage Directive 2014/35/EU
- RoHS Directive 2011/65/EU

Installation conditions

Minimum installation temperature	-20°C
Recommended min. bending radius	16 times the cable diameter
Recommended maximum tensile stress	50 N/mm ² of the cross-section of the copper

Functional characteristics

Rated voltage	300 V
Insulation resistance at 20°C	min. 100 MΩkm
Mutual capacity (800 Hz)	max. 120 nF/km
Capacity unbalance K1 (800 Hz)	max. 300 pF/100 m
Capacity unbalance K9-12(800 Hz)	max 100 pF/100 m

Formation	Approx. conductor \emptyset	Average insulation thickness	Average sheath thickness	Approx. external \emptyset	Max. electrical resistance at 20°C	Approx. cable weight
n° x mm ²	mm	mm	mm	mm	Ω /km	kg/km
1 x 2 x 0,8	0,8	0,3	1,4	6,1	73,2	50
2 x 2 x 0,8	0,8	0,3	1,4	6,9	73,2	75
4 x 2 x 0,8	0,8	0,3	1,4	9,0	73,2	115
6 x 2 x 0,8	0,8	0,3	1,4	10,3	73,2	140
10 x 2 x 0,8	0,8	0,3	1,4	12,2	73,2	210
20 x 2 x 0,8	0,8	0,3	1,4	16,4	73,2	375
30 x 2 x 0,8	0,8	0,3	1,4	19,8	73,2	550
40 x 2 x 0,8	0,8	0,3	1,4	23,0	73,2	715
50 x 2 x 0,8	0,8	0,3	1,4	26,6	73,2	985
60 x 2 x 0,8	0,8	0,3	1,6	27,6	73,2	1060
80 x 2 x 0,8	0,8	0,3	1,8	30,1	73,2	1345
100 x 2 x 0,8	0,8	0,3	1,8	32,6	73,2	1655

XVB cable

TRATOS XVB

For use in dry or humid indoor contexts with a fire risk. May be laid outdoor on pipes. Can be laid on buildings and metal structures. The underground installation shall be granted only if protected inside of corrugated or equivalent systems that provide mechanical protection. Good resistance to humidity, chemical agents and solar radiation.

Reference Construction Products Regulation 305/2011 EU and Standard EN 50575:

Given its properties of limiting the development of fire and heat emission, the cable is suitable for the supply of electricity in buildings and other civil engineering works.

FEATURES AND PERFORMANCES

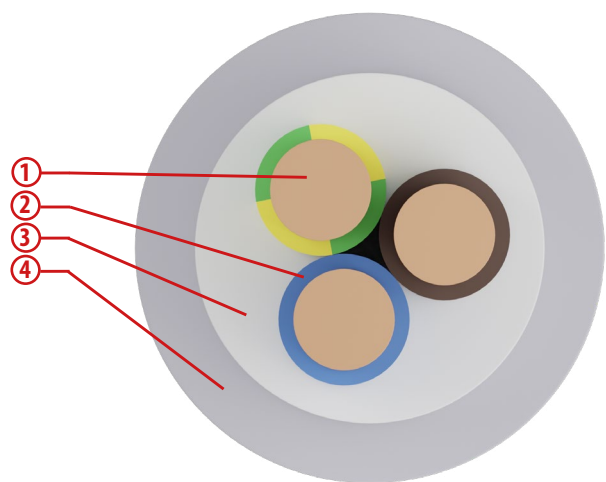

CONSTRUCTION

1. CLASS 1, SOLID, PLAIN COPPER (CROSS-SECTION $\leq 10 \text{ MM}^2$)
CLASS 2, STRANDED WIRE, PLAIN COPPER (CROSS-SECTION $\geq 16 \text{ MM}^2$)
2. XLPE (CROSS-LINKED POLYETHYLENE)
3. THERMOPLASTIC
4. PVC

Structure and electrical, physical, mechanical requirements: NBN HD 604 4-G

- Low Voltage Directive 2014/35/EU
- RoHS Directive 2011/65/EU

Installation conditions

Minimum installation temperature	0°C
Recommended min. bending radius	6 times the cable diameter
Recommended maximum tensile stress	50 N/mm ² of the cross-section of the copper

Functional characteristics

Rated voltage U ₀ /U	0,6/1 kV
Max. operating temperature	90°C
Min. operating temperature	-15°C (without mechanical shocks)
Max. short circuit temperature	250°C

Colours

SINGLE-CORE	●
TWO-CORE	● ●
THREE-CORE	● ● or ● ● ●
FOUR-CORE	● ● or ● ● ● ●
FIVE-CORE	● ● or ● ● ● ● ●

The cores in multiple cables for signal and control are black, numbered, with or without GREEN/YELLOW

Special features

UV resistance according to ISO 4892-2 method A (720 h).

Cable Marking

Tratos CEBEC 579 LTC XVB 0,6/1 kV Cca-s3,d2,a3 [form.] [year] [traceability] [metric]

Single-core

Formation	Approx. conductor \emptyset	Average insulation thickness	Average sheath thickness	Max. external \emptyset	Max. electrical resistance at 20°C	Approx. cable weight
n° x mm ²	mm	mm	mm	mm	Ω /km	kg/km
1 x 16	4,8	0,7	1,4	10,1	1,15	210
1 x 25	6,0	0,9	1,4	11,8	0,727	310
1 x 35	7,0	0,9	1,4	13,1	0,524	405
1 x 50	8,1	1,0	1,4	14,8	0,387	530
1 x 70	9,7	1,1	1,4	16,7	0,268	735
1 x 95	11,4	1,1	1,5	18,8	0,193	980
1 x 120	13,1	1,2	1,5	20,6	0,153	1230
1 x 150	14,6	1,4	1,6	23,0	0,124	1480
1 x 185	16,5	1,6	1,6	25,2	0,0991	1870
1 x 240	18,5	1,7	1,7	28,2	0,0754	2490
1 x 300	21,0	1,8	1,8	31,0	0,0601	3000

Two-core, three-core, four-core and five-core

Formation	Approx. conductor \emptyset	Average insulation thickness	Average sheath thickness	Max. external \emptyset	Max. electrical resistance at 20°C	Approx. cable weight
n° x mm ²	mm	mm	mm	mm	Ω /km	kg/km
2 x 1,5	1,4	0,7	1,4	10,7	12,1	105
2 x 2,5	1,8	0,7	1,4	11,6	7,41	125
2 x 4	2,3	0,7	1,4	12,8	4,61	180
2 x 6	2,8	0,7	1,4	13,9	3,08	235
2 x 10	3,5	0,7	1,4	15,8	1,83	350
2 x 16	4,8	0,7	1,4	17,9	1,15	500
2 x 25	6,0	0,9	1,6	21,8	0,727	890
3 x 1,5	1,4	0,7	1,4	11,1	12,1	115
3 x 2,5	1,8	0,7	1,4	12,2	7,41	155
3 x 4	2,3	0,7	1,4	13,5	4,61	215
3 x 6	2,8	0,7	1,4	14,7	3,08	290
3 x 10	3,5	0,7	1,4	16,7	1,83	435
3 x 16	4,8	0,7	1,5	19,1	1,15	630
3 x 25	6,0	0,9	1,6	23,2	0,727	1050
3 x 35	7,0	0,9	1,7	26,2	0,524	1250
4 x 1,5	1,4	0,7	1,4	12,1	12,1	135
4 x 2,5	1,8	0,7	1,4	13,1	7,41	185
4 x 4	2,3	0,7	1,4	14,6	4,61	270
4 x 6	2,8	0,7	1,4	16,0	3,08	370
4 x 10	3,5	0,7	1,5	18,4	1,83	560
4 x 16	4,8	0,7	1,5	21,0	1,15	790
4 x 25	6,0	0,9	1,7	25,6	0,727	1235
4 x 35	7,0	0,9	1,8	29,0	0,524	1720
5 x 1,5	1,4	0,7	1,4	13,0	12,1	165
5 x 2,5	1,8	0,7	1,4	14,2	7,41	225
5 x 4	2,3	0,7	1,4	15,8	4,61	320
5 x 6	2,8	0,7	1,4	17,3	3,08	420
5 x 10	3,5	0,7	1,5	19,8	1,83	680
5 x 16	4,8	0,7	1,6	23,1	1,15	970
5 x 25	6,0	0,9	1,7	28,1	0,727	1530

Four-core with reduced section

Formation	Approx. conductor \emptyset	Average insulation thickness	Average sheath thickness	Max. external \emptyset	Max. electrical resistance at 20°C	Approx. cable weight
$n^\circ \times \text{mm}^2$	mm	mm	mm	mm	Ω/km	kg/km
3 x 25 + 16	6,0/4,8	0,9/0,7	1,6	24,2	0,727/1,15	1220
3 x 35 + 16	7,0/4,8	0,9/0,7	1,7	26,8	0,524/1,15	1515

Multi-core

Formation	Approx. conductor \emptyset	Average insulation thickness	Average sheath thickness	Max. external \emptyset	Max. electrical resistance at 20°C	Approx. cable weight
$n^\circ \times \text{mm}^2$	mm	mm	mm	mm	Ω/km	kg/km
7 x 1,5	1,4	0,7	1,4	13,9	12,1	260
9 x 1,5	1,4	0,7	1,4	16,5	12,1	360
10 x 1,5	1,4	0,7	1,4	17,2	12,1	350
12 x 1,5	1,4	0,7	1,4	17,6	12,1	390

CABLES FOR A MOVING WORLD

TRATOS[®] ENERGY DNOs

Tratos Utility cables are designed and tested to meet relevant UK, European and International standards. Manufactured in state of the art manufacturing facilities, the company's purpose-built, in-house Fire, Chemical, Electrical and Physical testing facilities and laboratories deliver peace of mind to customers ensuring their choice of Utility cable products meet all statutory and regulatory requirements.



www.tratosgroup.com



EXVB cable

TRATOS EXVB

For fixed installation in industrial and civil. Recommended for underground installation in open channel, ducts, pipes or with appropriate protections. Equipped with reinforced sheath for added protection against mechanical stresses.

Reference Construction Products Regulation 305/2011 EU and Standard EN 50575:

The cable is suitable for the supply of electricity in buildings and other civil engineering works.

FEATURES AND PERFORMANCES

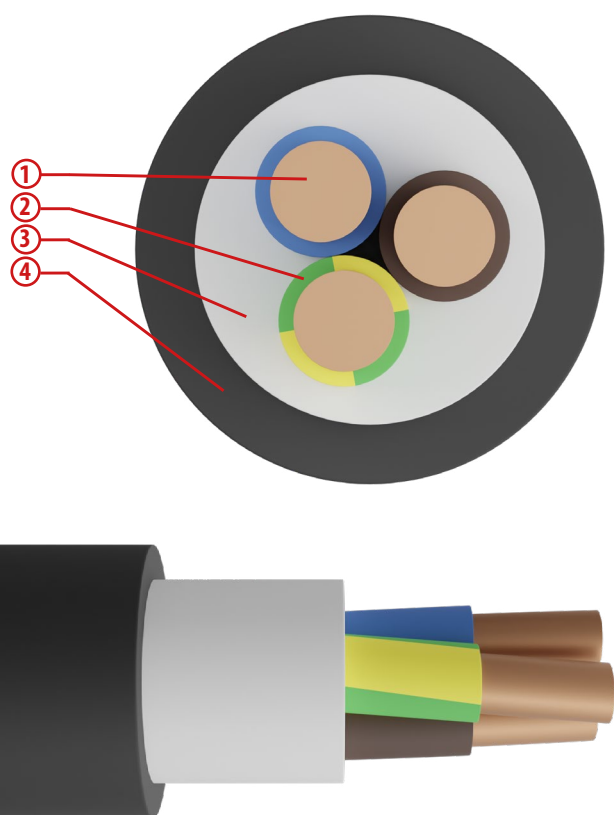

CONSTRUCTION

1. CLASS 1, SOLID, PLAIN COPPER (CROSS-SECTION $\leq 10 \text{ MM}^2$)
CLASS 2, STRANDED WIRE, PLAIN COPPER (CROSS-SECTION $\geq 16 \text{ MM}^2$)
2. XLPE (CROSS-LINKED POLYETHYLENE)
3. THERMOPLASTIC
4. PVC

Structure and electrical, physical, mechanical requirements: NBN HD 603:2007 NBN HD 603:2007/A1:2016

- **Low Voltage Directive** 2014/35/EU
- **RoHS Directive** 2011/65/EU

Installation conditions

Minimum installation temperature	-10°C
Recommended min. bending radius	6 times the cable diameter
Recommended maximum tensile stress	50 N/mm ² of the cross-section of the copper

Functional characteristics

Rated voltage U ₀ /U	0,6/1 kV
Max. operating temperature	90°C
Min. operating temperature	-25°C (without mechanical shocks)
Max. short circuit temperature	250°C

Cable Marking

Tratos CEBEC 579 EXVB 0,6/1 kV [form.] Eca [traceability] [year] [metric]

Colours

TWO-CORE	
THREE-CORE	or
FOUR-CORE	or
FIVE-CORE	or

Formation	Approx. conductor \emptyset	Nominal insulation thickness	Nominal sheath thickness	Max. external \emptyset	Max. electrical resistance at 20°C	Approx. cable weight	Current rating A	
							in air at 30°C	buried at 20°C
n° x mm ²	mm	mm	mm	mm	Ω /km	kg/km		
2 x 2,5	1,8	0,7	2,0	15,5	7,41	225	36	50
2 x 4	2,2	0,7	2,0	16,5	4,61	275	49	65
2 x 6	2,7	0,7	2,0	17,5	3,08	340	63	76
2 x 10	3,6	0,7	2,0	19,0	1,83	470	86	100
2 x 16	4,7	0,7	2,0	23,0	1,15	655	115	125
2 x 25	5,8	0,9	2,1	26,0	0,727	955	149	156
2 x 35	6,8	0,9	2,2	28,5	0,524	1225	185	187
3 x 1,5	1,4	0,7	2,0	15,0	12,1	210	23	30
3 x 2,5	1,8	0,7	2,0	16,0	7,41	255	32	40
3 x 4	2,2	0,7	2,0	17,0	4,61	315	42	50
3 x 6	2,7	0,7	2,0	18,0	3,08	400	54	65
3 x 10	3,6	0,7	2,0	21,0	1,83	565	75	90
3 x 16	4,7	0,7	2,1	24,0	1,15	810	100	120
3 x 25	5,8	0,9	2,2	28,0	0,727	1190	127	150
3 x 35	6,8	0,9	2,3	30,5	0,524	1545	157	175
3 x 50	7,9	1,0	2,4	33,5	0,387	2035	192	205
4 x 1,5	1,4	0,7	2,0	16,0	12,1	235	23	30
4 x 2,5	1,8	0,7	2,0	17,0	7,41	290	32	40
4 x 4	2,2	0,7	2,0	18,0	4,61	370	42	50
4 x 6	2,7	0,7	2,0	19,0	3,08	475	54	65
4 x 10	3,6	0,7	2,1	21,0	1,83	690	75	90
4 x 16	4,7	0,7	2,1	26,0	1,15	990	100	120
4 x 25	5,8	0,9	2,3	30,0	0,727	1490	127	150
4 x 35	6,8	0,9	2,3	33,0	0,524	1930	157	175
4 x 50	7,9	1,0	2,5	36,5	0,387	2550	192	205
5 x 1,5	1,4	0,7	2,0	16,5	12,1	270	23	30
5 x 2,5	1,8	0,7	2,0	18,0	7,41	330	32	40
5 x 4	2,2	0,7	2,0	19,0	4,61	430	42	50
5 x 6	2,7	0,7	2,0	20,5	3,08	545	54	65
5 x 10	3,6	0,7	2,1	24,0	1,83	830	75	90
5 x 16	4,7	0,7	2,2	28,0	1,15	1195	100	120
5 x 25	5,8	0,9	2,3	32,5	0,727	1795	127	150
5 x 35	6,8	0,9	2,4	35,5	0,524	2355	157	175

Permissible current rating values are according to:

- a buried cable with thermal resistivity of the ground equal to 1 K-m/W and laying depth of 700 mm

If conditions are different, apply correction factors of NBN HD 603 (Part 5 Section A Tables 1-2-3-4-5-6-7-8-9-10).

XGB cable

TRATOS XGB

Particularly recommended for fire risk areas with the presence of large number of people, due to its excellent fire retardant qualities and reduce fumes, toxic and corrosive gases emissions. For fixed applications inside dry or humid environments, or outdoor on buildings and metallic structures. Good resistance to humidity, chemical agents and solar radiation.

Reference Construction Products Regulation 305/2011 EU and Standard EN 50575:

Given its properties of limiting the development of fire, heat emission and noxious fumes, the cable is suitable for the supply of electricity in buildings and other civil engineering works.

FEATURES AND PERFORMANCES

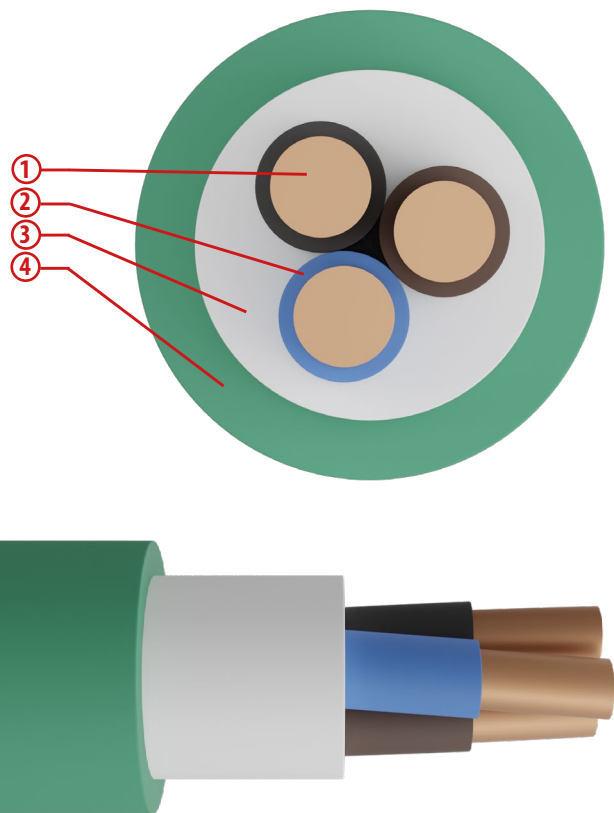

CONSTRUCTION

1. CLASS 1, SOLID, PLAIN COPPER (CROSS-SECTION $\leq 10 \text{ MM}^2$)
CLASS 2, STRANDED WIRE, PLAIN COPPER (CROSS-SECTION $\geq 16 \text{ MM}^2$)
2. XLPE (CROSS-LINKED POLYETHYLENE)
3. LSOH THERMOPLASTIC
4. LSOH POLYOLEFIN

Structure and electrical, physical, mechanical requirements: NBN HD 604 5-L

- Smoke density (transmittance) EN 61034-2
- Low Voltage Directive 2014/35/EU
- RoHS Directive 2011/65/EU

Installation conditions

Minimum installation temperature	0°C
Recommended min. bending radius	6 times the cable diameter
Recommended maximum tensile stress	50 N/mm ² of the cross-section of the copper

Functional characteristics

Rated voltage U ₀ /U	0,6/1 kV
Max. operating temperature	90°C
Min. operating temperature	-15°C (without mechanical shocks)
Max. short circuit temperature	250°C

Colours

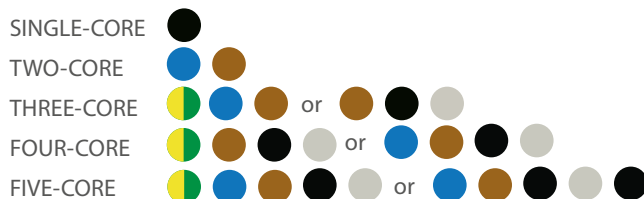

The cores in multiple cables for signal and control are black, numbered, with or without GREEN/YELLOW

Special features

UV resistance according to ISO 4892-2 method A (720 h).

Cable Marking

Tratos CEBEC 579 TRISECUR XGB 0,6/1 kV Cca-s1,d2,a1 [form.]
[year] [traceability] [metric]

Single-core

Formation	Approx. conductor \emptyset	Average insulation thickness	Average sheath thickness	Max. external \emptyset	Max. electrical resistance at 20°C	Approx. cable weight
n° x mm ²	mm	mm	mm	mm	Ω /km	kg/km
1 x 10	3,5	0,7	1,4	9,0	1,83	170
1 x 16	4,8	0,7	1,4	10,1	1,15	235
1 x 25	6,0	0,9	1,4	11,8	0,727	340
1 x 35	7,0	0,9	1,4	13,1	0,524	435
1 x 50	8,1	1,0	1,4	14,8	0,387	560
1 x 70	9,7	1,1	1,4	16,7	0,268	775
1 x 95	11,4	1,1	1,5	18,8	0,193	1024
1 x 120	13,1	1,2	1,5	20,6	0,153	1355
1 x 150	14,6	1,4	1,6	23,0	0,124	1640
1 x 185	16,5	1,6	1,6	25,2	0,0991	2050
1 x 240	18,5	1,7	1,7	28,2	0,0754	2590
1 x 300	21,0	1,8	1,8	31,0	0,0601	3190

TRATOS General Cables®

Two-core, three-core, four-core and five-core

Formation	Approx. conductor \emptyset	Average insulation thickness	Average sheath thickness	Max. external \emptyset	Max. electrical resistance at 20°C	Approx. cable weight
$n^{\circ} \times \text{mm}^2$	mm	mm	mm	mm	Ω/km	kg/km
2 x 1,5	1,4	0,7	1,4	10,7	12,1	130
2 x 2,5	1,8	0,7	1,4	11,6	7,41	155
2 x 4	2,3	0,7	1,4	12,8	4,61	215
2 x 6	2,8	0,7	1,4	13,9	3,08	285
2 x 10	3,5	0,7	1,4	15,8	1,83	470
2 x 16	4,8	0,7	1,4	17,9	1,15	550
2 x 25	6,0	0,9	1,6	21,8	0,727	890
2 x 35	7,0	0,9	1,6	24,4	0,524	1160
3 x 1,5	1,4	0,7	1,4	11,1	12,1	175
3 x 2,5	1,8	0,7	1,4	12,2	7,41	185
3 x 4	2,3	0,7	1,4	13,5	4,61	250
3 x 6	2,8	0,7	1,4	14,7	3,08	320
3 x 10	3,5	0,7	1,4	16,7	1,83	470
3 x 16	4,8	0,7	1,5	19,1	1,15	690
3 x 25	6,0	0,9	1,6	23,2	0,727	1040
4 x 1,5	1,4	0,7	1,4	12,1	12,1	170
4 x 2,5	1,8	0,7	1,4	13,1	7,41	220
4 x 4	2,3	0,7	1,4	14,6	4,61	300
4 x 6	2,8	0,7	1,4	16,0	3,08	390
4 x 10	3,5	0,7	1,5	18,4	1,83	585
4 x 16	4,8	0,7	1,5	21,0	1,15	855
4 x 25	6,0	0,9	1,7	25,6	0,727	1320
4 x 35	7,0	0,9	1,8	29,0	0,524	1755
5 x 1,5	1,4	0,7	1,4	13,0	12,1	195
5 x 2,5	1,8	0,7	1,4	14,2	7,41	260
5 x 4	2,3	0,7	1,4	15,8	4,61	350
5 x 6	2,8	0,7	1,4	17,3	3,08	470
5 x 10	3,5	0,7	1,5	19,8	1,83	715
5 x 16	4,8	0,7	1,6	23,1	1,15	1055
5 x 25	6,0	0,9	1,7	28,1	0,727	1605

Multi-core

Formation	Approx. conductor \emptyset	Average insulation thickness	Average sheath thickness	Max. external \emptyset	Max. electrical resistance at 20°C	Approx. cable weight
$n^{\circ} \times \text{mm}^2$	mm	mm	mm	mm	Ω/km	kg/km
7 x 1,5	1,4	0,7	1,4	13,9	12,1	225
9 x 1,5	1,4	0,7	1,4	16,5	12,1	320
10 x 1,5	1,4	0,7	1,4	17,2	12,1	330
12 x 1,5	1,4	0,7	1,4	17,6	12,1	360
14 x 1,5	1,4	0,7	1,5	18,7	12,1	420
19 x 1,5	1,4	0,7	1,5	20,6	12,1	520

CABLES FOR A MOVING WORLD

TRATOS[®] ENERGY DNOs

Tratos Utility cables are designed and tested to meet relevant UK, European and International standards. Manufactured in state of the art manufacturing facilities, the company's purpose-built, in-house Fire, Chemical, Electrical and Physical testing facilities and laboratories deliver peace of mind to customers ensuring their choice of Utility cable products meet all statutory and regulatory requirements.



www.tratosgroup.com



VVT cable

TRATOS VVT

For indoor connection of telephone equipment in places at risk of fire. Good resistance to humidity, atmospheric agents and chemical agents in general.

Reference Construction Products Regulation 305/2011 EU and Standard EN 50575:

Given its properties of limiting the development of fire, heat emission and noxious fumes, the cable is suitable for the supply of electricity in buildings and other civil engineering works.

FEATURES AND PERFORMANCES

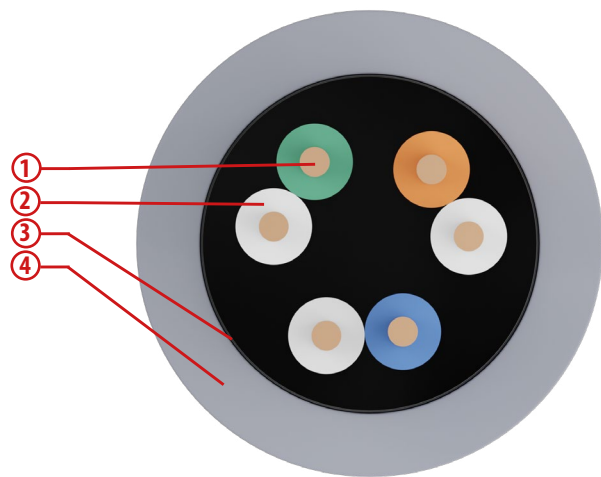

CONSTRUCTION

1. TINNED COPPER, SOLID, CLASS 1
2. PVC, T11 QUALITY
3. POLYESTER FOIL FOR CABLES HAVING 3 OR MORE PAIRS
4. PVC TERMOPLASTIC COMPOUND, TM1 QUALITY

Structure and electrical, physical, mechanical requirements: ref. to IEC 60189-2

- **Smoke density (transmittance)** EN 61034-2
- **Low Voltage Directive** 2014/35/EU
- **RoHS Directive** 2011/65/EU

Installation conditions

Minimum installation temperature	0°C
Recommended min. bending radius	10 times the cable diameter
Recommended maximum tensile stress	50 N/mm ² of the cross-section of the copper

Functional characteristics

Rated voltage	150 V
Insulation resistance at 20°C: min.	1000 MΩ·km
Max. short circuit temperature	150°C

Cable Marking

Tratos VVT Cca-s3,d2,a3 [form.] [year] [traceability]

Formation	Approx. conductor \emptyset	Average insulation thickness	Average sheath thickness	Approx. external \emptyset	Max. electrical resistance at 20°C	Approx. cable weight
n° x mm ²	mm	mm	mm	mm	Ω /km	kg/km
1 x 3 x 0,6	0,6	0,18	0,8	4,0	67,9	33
1 x 4 x 0,6 + T	0,6 + 0,4	0,18	0,8	4,2	67,9	36
3 x 2 x 0,6 + T	0,6 + 0,4	0,18	0,8	5,4	67,9	48
4 x 2 x 0,6 + T	0,6 + 0,4	0,18	0,8	5,8	67,9	60
6 x 2 x 0,6 + T	0,6 + 0,4	0,18	0,8	6,3	67,9	69
8 x 2 x 0,6 + T	0,6 + 0,4	0,18	0,8	7,3	67,9	85
10 x 2 x 0,6 + T	0,6 + 0,4	0,18	0,8	7,8	67,9	96
14 x 2 x 0,6 + T	0,6 + 0,4	0,18	0,8	9,2	67,9	135
20 x 2 x 0,6 + T	0,6 + 0,4	0,18	0,8	10,7	67,9	180
26 x 2 x 0,6 + T	0,6 + 0,4	0,18	0,8	11,7	67,9	225
30 x 2 x 0,6 + T	0,6 + 0,4	0,18	1,0	12,6	67,9	260
40 x 2 x 0,6 + T	0,6 + 0,4	0,18	1,0	14,2	67,9	300
50 x 2 x 0,6 + T	0,6 + 0,4	0,18	1,0	15,8	67,9	405
100 x 2 x 0,6 + T	0,6 + 0,4	0,18	1,2	21,0	67,9	610

TT cable

TRATOS TT (CH-N1VV-U/R)

For use in industrial electrical systems. Can be laid outdoor, in humid, dry or rainy environments, and indoor in brickwork and concrete structures.

Reference Construction Products Regulation 305/2011 EU and Standard EN 50575:

The cable is suitable for the supply of electricity in buildings and other civil engineering works.

FEATURES AND PERFORMANCES

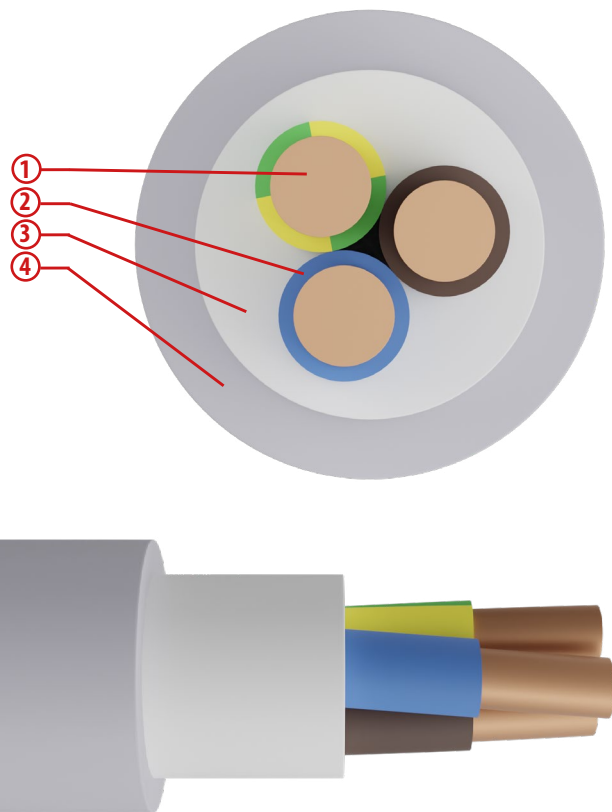

CONSTRUCTION

1. CLASS 1, SOLID, PLAIN COPPER (CROSS-SECTION $\leq 6 \text{ MM}^2$)
CLASS 2, STRANDED WIRE, PLAIN COPPER (CROSS-SECTION $\geq 10 \text{ MM}^2$)
2. PVC
3. THERMOPLASTIC (OPTIONAL)
4. PVC

Structure and electrical, physical, mechanical requirements: SEV 1101:2010

- Low Voltage Directive 2014/35/EU
- RoHS Directive 2011/65/EU

Installation conditions

Minimum installation temperature	0°C
Recommended min. bending radius	4 times the cable diameter
Recommended maximum tensile stress	50 N/mm ² of the cross-section of the copper

Functional characteristics

Rated voltage U ₀ /U	0,6/1 kV
Max. operating temperature	70°C
Min. operating temperature	-15°C (without mechanical shocks)
Max. short circuit temperature	160°C

Cable Marking

Tratos TT 0,6/1 kV [form.] (xxxx) Eca [traceability] [year] [metric]

Colours

SINGLE-CORE	●
TWO-CORE	● or ●
THREE-CORE	● or ● or ●
FOUR-CORE	● or ● or ● or ●
FIVE-CORE	● or ● or ● or ● or ●

The cores in multiple cables for signal and control are black, numbered, with or without GREEN/YELLOW

Single-core and two-core

Formation	Approx. conductor \emptyset	Average insulation thickness	Average sheath thickness	Max. external \emptyset	Max. electrical resistance at 20°C	Approx. cable weight
n° x mm ²	mm	mm	mm	mm	Ω /km	kg/km
1 x 6	3,1	0,8	0,75	6,0	3,08	84
2 x 1,5	1,4	0,7	0,85	7,2	12,1	88
2 x 2,5	1,8	0,8	0,95	8,5	7,41	130
2 x 4	2,3	0,8	1,0	9,6	4,61	170
2 x 6	3,1	0,8	1,0	10,9	3,08	230
2 x 10	4,0	1,0	1,2	14,3	1,83	405
2 x 16	4,8	1,0	1,4	16,1	1,15	575

Three-core, four-core and five-core

Formation	Approx. conductor \emptyset	Average insulation thickness	Average sheath thickness	Max. external \emptyset	Max. electrical resistance at 20°C	Approx. cable weight
n° x mm ²	mm	mm	mm	mm	Ω /km	kg/km
3 x 1,5	1,4	0,7	0,9	7,7	12,1	100
3 x 2,5	1,8	0,8	0,95	9,2	7,41	150
3 x 4	2,3	0,8	1,0	10,4	4,61	205
3 x 6	3,1	0,8	1,1	11,6	3,08	275
3 x 10	4,0	1,0	1,3	15,4	1,83	495
4 x 1,5	1,4	0,7	0,95	8,5	12,1	125
4 x 2,5	1,8	0,8	1,0	10,2	7,41	180
4 x 4	2,3	0,8	1,1	11,5	4,61	255
4 x 6	3,1	0,8	1,2	12,9	3,08	370
4 x 10	4,0	1,0	1,4	17,1	1,83	615
4 x 16	4,8	1,0	1,5	19,3	1,15	895
4 x 25	6,0	1,2	1,9	24,1	0,727	1390
5 x 1,5	1,4	0,7	1,0	9,4	12,1	150
5 x 2,5	1,8	0,8	1,1	11,3	7,41	220
5 x 4	2,3	0,8	1,2	12,6	4,61	320
5 x 6	3,1	0,8	1,2	14,2	3,08	435
5 x 10	4,0	1,0	1,5	18,9	1,83	770
5 x 16	4,8	1,0	1,7	21,2	1,15	1110
5 x 25	6,0	1,2	2,0	26,5	0,727	1720

Multi-core

Formation	Approx. conductor \emptyset	Average insulation thickness	Average sheath thickness	Max. external \emptyset	Max. electrical resistance at 20°C	Approx. cable weight
n° x mm ²	mm	mm	mm	mm	Ω /km	kg/km
7 x 1,5	1,4	0,7	1,0	10,5	12,1	200
8 x 1,5	1,4	0,7	1,1	11,3	12,1	240
10 x 1,5	1,4	0,7	1,2	13,0	12,1	290
12 x 1,5	1,4	0,7	1,2	13,7	12,1	320
16 x 1,5	1,4	0,7	1,3	14,8	12,1	420
7 x 2,5	1,8	0,8	1,1	12,5	7,41	300
8 x 2,5	1,8	0,8	1,2	13,6	7,41	365

FE0 D cable

TRATOS FE0 D

Recommended in places where is necessary to protect against the emission of fumes, toxic and corrosive gases in case of fire. Underground installation is not permitted even if protected.

Reference Construction Products Regulation 305/2011 EU and Standard EN 50575:

Given its properties of limiting the development of fire and heat emission, the cable is suitable for the supply of electricity in buildings and other civil engineering works.

FEATURES AND PERFORMANCES

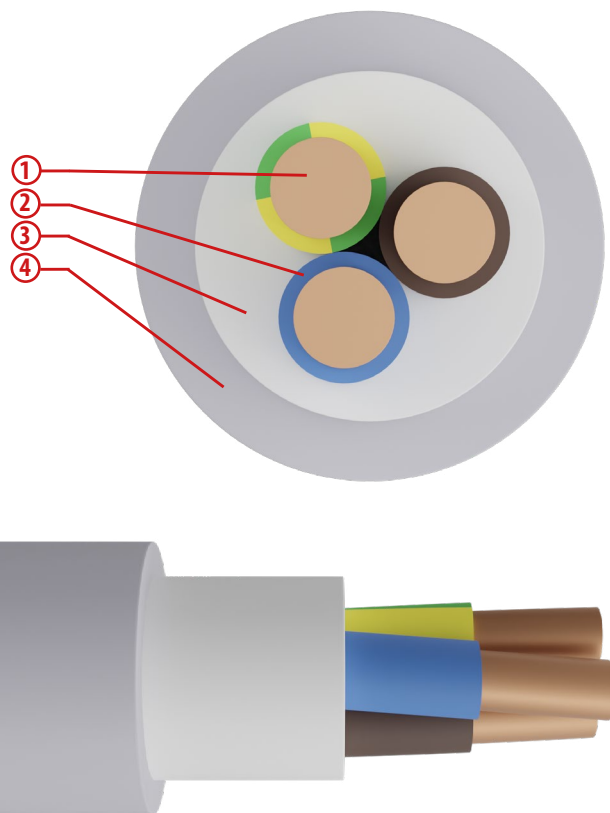

CONSTRUCTION

1. CLASS 1, SOLID, PLAIN COPPER (CROSS-SECTION $\leq 6 \text{ MM}^2$)
CLASS 2, STRANDED WIRE, PLAIN COPPER (CROSS-SECTION $\geq 10 \text{ MM}^2$)
2. POLYETHYLENE
3. LS0H THERMOPLASTIC
4. LS0H THERMOPLASTIC COMPOUND

LS0H = Low Smoke Zero Halogen

Structure and electrical, physical, mechanical requirements: (insulation and sheath thickness) TPV-008 EN 60228

- **Low Voltage Directive** 2014/35/EU
- **RoHS Directive** 2011/65/EU

Installation conditions

Minimum installation temperature	5°C
Recommended min. bending radius	6 times the cable diameter
Recommended maximum tensile stress	50 N/mm ² of the cross-section of the copper

Functional characteristics

Rated voltage U ₀ /U	0,6/1 kV
Max. operating temperature	70°C
Min. operating temperature	-15°C (without mechanical shocks)
Max. short circuit temperature	160°C

Cable Marking

Tratos FE0 D [form.] [core identif.] Dca-s2,d2,a2 halogenfrei
0,6/1kV [traceability] [year] [metric]

Formation	Approx. conductor \emptyset	Approx. overall \emptyset	Max. electrical resistance at 20°C	Approx. cable weight	Current rating at 30°C A		
					n° x mm ²	mm	mm
1 x 6	2,8	5,6	3,08	74		36	46
1 x 10	4,0	7,2	1,83	125		50	63
1 x 16	4,8	8,2	1,15	185		68	85
1 x 25	6,0	9,6	0,727	275		89	114
1 x 35	7,0	10,9	0,524	370		110	143
1 x 50	8,1	12,2	0,387	495		134	174
2 x 1,5	1,4	6,6	12,1	69		16,5	22
2 x 2,5	1,8	7,7	7,41	100		23	30
3 x 1,5	1,4	7,0	12,1	84		15	18,5
3 x 2,5	1,8	8,1	7,41	125		20	25
3 x 4	2,3	9,4	4,61	180		27	34
3 x 6	2,8	10,7	3,08	250		34	43
4 x 1,5	1,4	7,7	12,1	110		15	18,5
4 x 2,5	1,8	8,9	7,41	155		20	25
4 x 4	2,3	10,2	4,61	225		27	34
4 x 6	2,8	11,8	3,08	320		34	43
5 x 1,5	1,4	8,4	12,1	120		15	18,5
5 x 2,5	1,8	9,8	7,41	185		20	25
5 x 4	2,3	11,1	4,61	275		27	34
5 x 6	2,8	13,0	3,08	385		34	43
5 x 10	4,0	17,1	1,83	665		46	60
6 x 1,5	1,4	9,0	12,1	145		10	12
7 x 2,5	1,8	10,5	7,41	250		13	16
7 x 4	2,3	12,0	4,61	365		18	22
7 x 6	2,8	14,0	3,08	520		22	28
8 x 1,5	1,4	10,1	12,1	210		8	10
10 x 1,5	1,4	11,8	12,1	240		8	10

N.B. Permissible current rating values are according to:

- two conductors charged for two cable
- three conductors charged for cable single core, three core, four core and five core

FE05C cable

TRATOS FE05C

Particularly recommended for fire risk areas with the presence of large number of people, due to its excellent fire retardant qualities and reduce fumes, toxic and corrosive gases emissions.

Reference Construction Products Regulation 305/2011 EU and Standard EN 50575:

Given its properties of limiting the development of fire and heat emission, the cable is suitable for the supply of electricity in buildings and other civil engineering works.

FEATURES AND PERFORMANCES

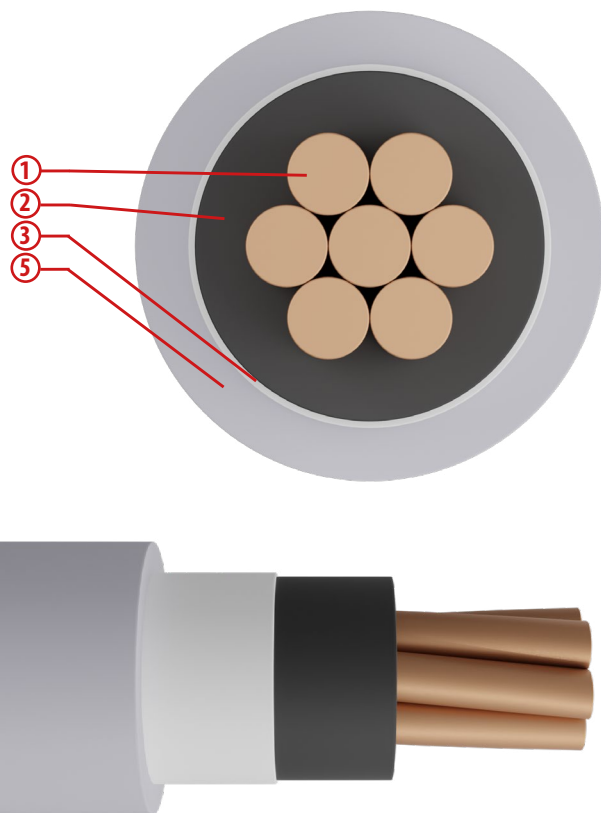

CONSTRUCTION

1. CLASS 1, SOLID, PLAIN COPPER (CROSS-SECTION $\leq 6 \text{ MM}^2$)
CLASS 2, STRANDED WIRE, PLAIN COPPER (CROSS-SECTION $\geq 10 \text{ MM}^2$)
2. CROSS-LINKED POLYETHYLENE
3. PAPER TAPE
4. LS0H THERMOPLASTIC (ONLY FOR MULTI-CORE CABLES)
5. LS0H POLYOLEFIN

LS0H = Low Smoke Zero Halogen

Structure and electrical, physical, mechanical requirements: (insulation and sheath thickness) SEV TPV-003 EN 60228

- **Low Voltage Directive** 2014/35/EU
- **RoHS Directive** 2011/65/EU

Installation conditions

Minimum installation temperature	5°C
Recommended min. bending radius	6 times the cable diameter
Recommended maximum tensile stress	50 N/mm ² of the cross-section of the copper

Functional characteristics

Rated voltage U ₀ /U	0,6/1 kV
Max. operating temperature	90°C
Min. operating temperature	-15°C (without mechanical shocks)
Max. short circuit temperature	250°C

Cable Marking

Tratos FE05C [form.] [core identif.] Cca-s1,d1,a1 halogenfrei
0,6/1kV [traceability] [year] [metric]

Formation	Approx. conductor Ø	Approx. overall Ø	Max. electrical resistance at 20°C	Approx. cable weight
n° x mm ²	mm	mm	Ω/km	kg/km
1 x 10	4,0	9,1	1,83	165
1 x 16	4,8	10,1	1,15	230
1 x 25	6,0	11,5	0,727	330
1 x 35	7,0	12,5	0,524	430
1 x 50	8,1	13,8	0,387	550
1 x 70	9,7	15,6	0,268	760
1 x 95	11,4	17,7	0,193	1025
1 x 120	13,1	19,2	0,153	1275
1 x 150	14,6	20,9	0,124	1530
1 x 185	16,5	23,0	0,0991	1920
1 x 240	18,5	26,1	0,0754	2465
1 x 300	21,0	28,5	0,0601	3060
2 x 1,5	1,4	8,5	12,10	110
2 x 2,5	1,8	9,4	7,41	140
2 x 25	6,0	20,2	0,727	890
3 x 1,5	1,4	8,8	12,10	125
3 x 2,5	1,8	9,8	7,41	180
3 x 4	2,3	10,8	4,61	240
3 x 6	2,8	12,1	3,08	315
3 x 10	4,0	14,9	1,83	495
4 x 1,5	1,4	9,4	12,10	160
4 x 2,5	1,8	10,5	7,41	195
4 x 4	2,3	11,6	4,61	265
4 x 6	2,8	13,1	3,08	360
4 x 10	4,0	16,2	1,83	545
5 x 1,5	1,4	10,4	12,10	175
5 x 2,5	1,8	11,7	7,41	240
5 x 4	2,3	12,5	4,61	310
5 x 6	2,8	14,1	3,08	430
5 x 10	4,0	17,7	1,83	695
6 x 1,5	1,4	12,4	12,10	250
7 x 1,5	1,4	12,4	12,10	260
7 x 2,5	1,8	13,8	7,41	340
7 x 4	2,3	15,2	4,61	470
8 x 1,5	1,4	12,8	12,10	290
10 x 1,5	1,4	14,0	12,10	330
12 x 1,5	1,4	14,6	12,10	365
12 x 2,5	1,8	16,6	7,41	510
16 x 1,5	1,4	15,8	12,10	500
21 x 1,5	1,4	18,0	12,10	580

AT-N05VV-U (YM-J/O) cable

TRATOS AT-N05VV-U (YM-J/O)

For permanent installation in dry, damp or wet rooms. Not suitable for direct installation in concrete if the concrete is subjected to a vibrating process. Not suitable for unprotected installation outdoors or in channels or ducts. In channels or ducts, laying in accordance with ÖVE/ÖNORM E 8120 is possible up to a length of 50 m in the protective conduit.

Reference Construction Products Regulation 305/2011 EU and Standard EN 50575:

The cable is suitable for the supply of electricity in buildings and other civil engineering works.

FEATURES AND PERFORMANCES

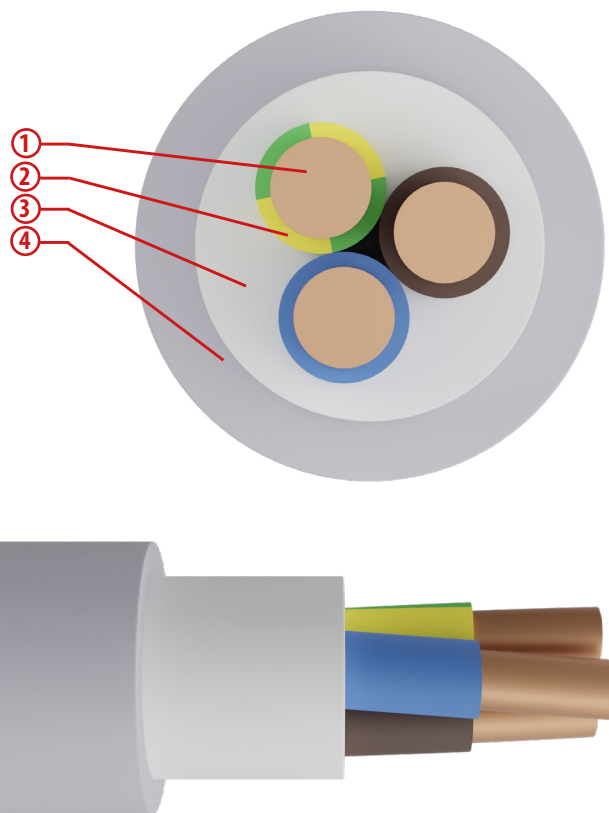

CONSTRUCTION

1. CLASS 1, SOLID, PLAIN COPPER
2. PVC
3. THERMOPLASTIC
4. PVC

Structure and electrical, physical, mechanical requirements: ÖVE/ÖNORM E 8242:2014

- **Flame propagation** EN 60332-1-2
- **Low Voltage Directive** 2014/35/EU
- **RoHS Directive** 2011/65/EU

Installation conditions

Minimum installation temperature	5°C
Recommended min. bending radius	12 times the cable diameter
Recommended maximum tensile stress	50 N/mm ² of the cross-section of the copper

Functional characteristics

Rated voltage U ₀ /U	300/500 V
Max. operating temperature	70°C
Min. operating temperature	-10°C (without mechanical shocks)
Max. short circuit temperature	160°C

Cable Marking

Tratos AT-N05VV-U (YM-J/O) [form.] Eca [year] [traceability]

Colours

- THREE-CORE or
- FOUR-CORE or
- FIVE-CORE or

AT-N05VV-U (YM-J) with conductor green/yellow
 AT-N05VV-U (YM-O) without conductor green/yellow

Formation	Approx. conductor \emptyset	Average insulation thickness	Average sheath thickness	Approx. external \emptyset	Approx. cable weight	Max. electrical resistance at 20°C
n° x mm ²	mm	mm	mm	mm	kg/km	Ω /km
3 x 1,5	1,4	0,7	1,2	8,4	125	12,1
3 x 2,5	1,8	0,8	1,2	9,6	170	7,41
4 x 1,5	1,4	0,7	1,2	9,1	150	12,1
4 x 2,5	1,8	0,8	1,2	10,4	210	7,41
5 x 1,5	1,4	0,7	1,2	9,8	170	12,1
5 x 2,5	1,8	0,8	1,2	11,3	245	7,41
5 x 4	2,2	0,8	1,4	13,0	345	4,61
5 x 6	2,7	0,8	1,4	14,4	470	3,08

MMJ cable

TRATOS MMJ

Suitable for energy supply in industry, workshops, residential building, and in agricultural applications. For fixed installations inside and outside. It must not be laid underground even if protected.

Reference Construction Products Regulation 305/2011 EU and Standard EN 50575:

The cable is suitable for the supply of electricity in buildings and other civil engineering works.

FEATURES AND PERFORMANCES

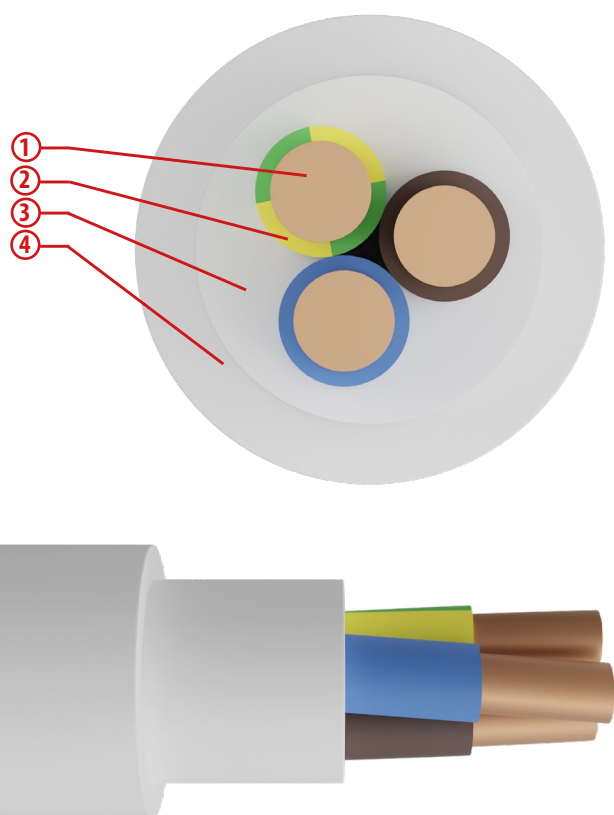

CONSTRUCTION

1. CLASS 1, SOLID, PLAIN COPPER (CROSS-SECTION 1,5 ÷ 2,5)
- CLASS 2, STRANDED WIRE, PLAIN COPPER (CROSS-SECTION 4 ÷ 25)
2. PVC
3. THERMOPLASTIC
4. PVC

Structure and electrical, physical, mechanical requirements: SFS 2091:2011

- **Low Voltage Directive** 2014/35/EU
- **RoHS Directive** 2011/65/EU

Installation conditions

Minimum installation temperature	-15°C
Recommended min. bending radius	6 times the cable diameter
Recommended maximum tensile stress	50 N/mm ² of the cross-section of the copper

Functional characteristics

Rated voltage U ₀ /U	300/500 V - 450/750 V
Max. operating temperature	70°C
Min. operating temperature	-30°C (without mechanical shocks)
Max. short circuit temperature	160°C

Cable Marking

Tratos MMJ [form.] mm² N/S 300/500 V SFS 2091 (FI logo) [year] CE [metric]

Tratos MMJ [form.] mm² N/S 450/750 V SFS 2091 (FI logo) [year] CE [metric]

Colours

TWO-CORE	● ●
THREE-CORE	● ● ● or ● ● ●
FOUR-CORE	● ● ● ● or ● ● ● ●
FIVE-CORE	● ● ● ● ● or ● ● ● ● ●

MMJ U_o/U: 300/500V

Formation	Approx. conductor Ø	Average insulation thickness	Average sheath thickness	Approx. external Ø	Approx. cable weight	Max. electrical resistance at 20°C
n° x mm ²	mm	mm	mm	mm	kg/km	Ω/km
2 x 2,5	1,8	0,8	1,2	9,2	135	7,41
3 x 1,5	1,4	0,7	1,2	8,5	115	12,1
3 x 2,5	1,8	0,8	1,2	9,7	160	7,41
4 x 1,5	1,4	0,7	1,2	9,2	140	12,1
4 x 2,5	1,8	0,8	1,2	10,6	195	7,41
5 x 1,5	1,4	0,7	1,2	10,0	165	12,1
5 x 2,5	1,8	0,8	1,2	11,5	230	7,41

MMJ U_o/U: 450/750V

Formation	Approx. conductor Ø	Average insulation thickness	Average sheath thickness	Approx. external Ø	Approx. cable weight	Max. electrical resistance at 20°C
n° x mm ²	mm	mm	mm	mm	kg/km	Ω/km
2 x 6	3,1	0,8	1,5	12,4	275	3,08
2 x 10	3,9	1,0	1,5	14,8	420	1,83
2 x 16	5,0	1,0	1,6	16,8	590	1,15
2 x 25	6,2	1,2	1,6	19,8	880	0,727
3 x 6	3,1	0,8	1,5	13,1	340	3,08
3 x 10	3,9	1,0	1,5	15,7	520	1,83
3 x 16	5,0	1,0	1,6	17,6	735	1,15
3 x 25	6,2	1,2	1,7	21,3	1120	0,727
4 x 6	3,1	0,8	1,5	14,4	435	3,08
4 x 10	3,9	1,0	1,6	17,5	650	1,83
4 x 16	5,0	1,0	1,7	19,6	920	1,15
4 x 25	6,2	1,2	1,7	23,5	1415	0,727
5 x 6	3,1	0,8	1,5	15,7	500	3,08
5 x 10	3,9	1,0	1,7	19,3	795	1,83
5 x 16	5,0	1,0	1,7	21,5	1120	1,15
5 x 25	6,2	1,2	1,8	26,0	1730	0,727
3 x 4 *	2,5	0,8	1,5	12,0	255	4,61
4 x 4 *	2,5	0,8	1,5	13,0	310	4,61
5 x 4 *	2,5	0,8	1,5	14,2	375	4,61

* not included in SFS 2091:2011

MMJ-HF cable

TRATOS MMJ-HF

This cable is recommended for use in public and industrial settings whenever good fire retardant qualities, reduced fumes, toxic and corrosive gases emissions are required in the case of fire. It must not be laid underground.

Reference Construction Products Regulation 305/2011 EU and Standard EN 50575:

Given its properties of limiting the development of fire, heat emission and noxious fumes, the cable is suitable for the supply of electricity in buildings and other civil engineering works.

FEATURES AND PERFORMANCES

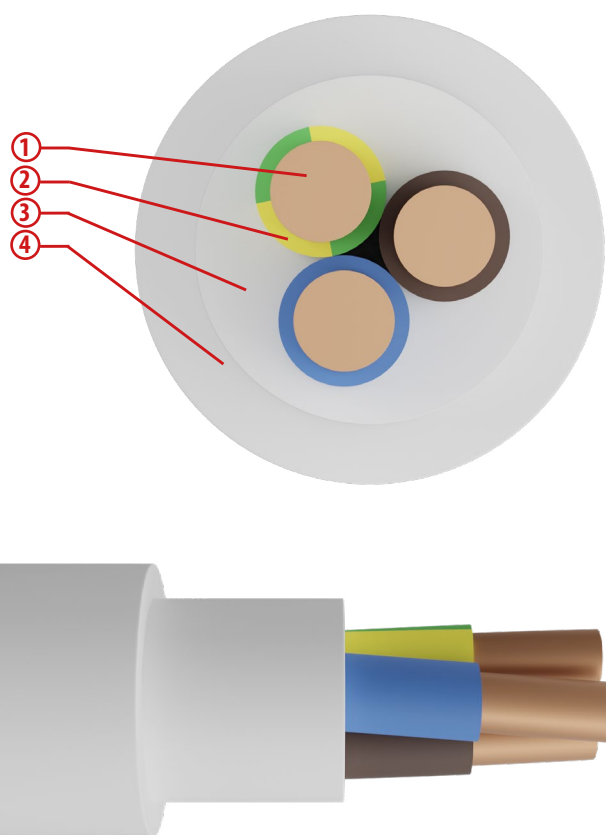

CONSTRUCTION

1. CLASS 1, SOLID, PLAIN COPPER (CROSS-SECTION 1,5 ÷ 2,5)
CLASS 2, STRANDED WIRE, PLAIN COPPER (CROSS-SECTION 6 ÷ 10)
2. LSOH THERMOPLASTIC
3. LSOH THERMOPLASTIC
4. LSOH THERMOPLASTIC

LSOH = Low Smoke Zero Halogen

Structure and electrical, physical, mechanical requirements: SFS 5544

- Fire propagation EN 60332-3-23
- Corrosive gases or halogens EN 50267-2-1
IEC 754-1
- Low Voltage Directive 2014/35/EU
- RoHS Directive 2011/65/EU

Installation conditions

Minimum installation temperature	-15°C
Recommended min. bending radius	6 times the cable diameter
Recommended maximum tensile stress	50 N/mm ² of the cross-section of the copper

Functional characteristics

Rated voltage U ₀ /U	450/750 V
Max. operating temperature	70°C
Min. operating temperature	-30°C (without mechanical shocks)
Max. short circuit temperature	160°C

Cable Marking

Tratos MMJ-HF [form.] N/S 450/750V [year]

Colours

THREE-CORE  or 

FOUR-CORE  or 

FIVE-CORE  or 

Formation	Approx. conductor \emptyset	Average insulation thickness	Average sheath thickness	Approx. external \emptyset	Max. electrical resistance at 20°C	Approx. cable weight
n° x mm ²	mm	mm	mm	mm	Ω /km	kg/km
3 x 1,5	1,4	0,7	1,5	9,9	12,1	170
3 x 2,5	1,8	0,8	1,5	11,1	7,41	205
3 x 4	2,5	0,8	1,5	12,5	4,61	280
4 x 1,5	1,4	0,7	1,5	10,6	12,1	180
5 x 1,5	1,4	0,7	1,5	11,1	12,1	200
5 x 2,5	1,8	0,8	1,5	12,6	7,41	285
5 x 4	2,8	0,8	1,5	14,6	4,61	405
5 x 6	3,1	0,8	1,5	16,1	3,08	535
5 x 10	3,9	1,0	1,7	20,1	1,83	870

EXQ TRI-LIGHT cable

TRATOS EXQ TRI-LIGHT

This cable is recommended for use in public and industrial settings whenever good fire retardant qualities, reduced fumes, toxic and corrosive gases emissions are required in the case of fire. It may be installed outdoors but underground installation is not permitted.

Reference Construction Products Regulation 305/2011 EU and Standard EN 50575:

Given its properties of limiting the development of fire, heat emission and noxious fumes, the cable is suitable for the supply of electricity in buildings and other civil engineering works.

FEATURES AND PERFORMANCES

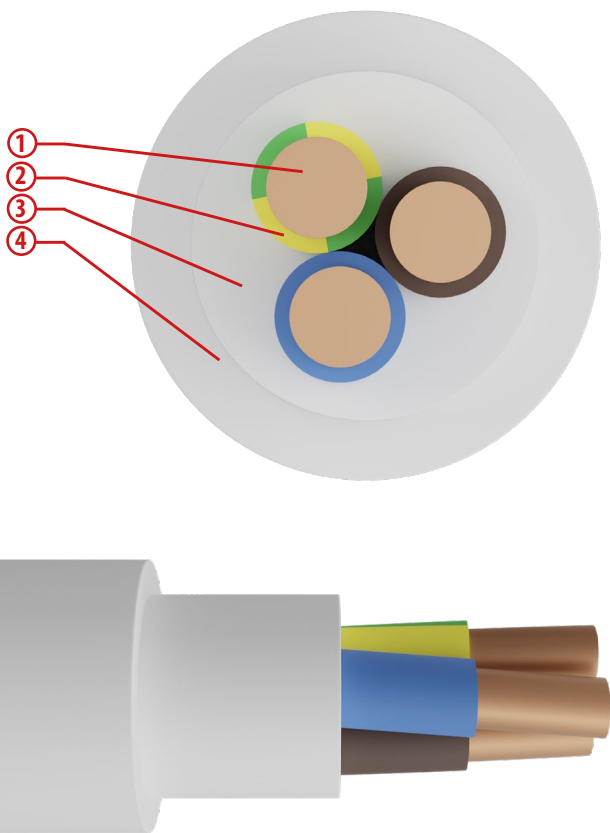

CONSTRUCTION

1. CLASS 1, SOLID, PLAIN COPPER
2. CROSS-LINKED POLYETHYLENE (XLPE)
3. LS0H THERMOPLASTIC
4. LS0H THERMOPLASTIC, UV RESISTANT

LS0H = Low Smoke Zero Halogen

Structure and electrical, physical, mechanical requirements: where appl. NEK 591:2019 where appl. SS424 02 19-5

- **Smoke density** EN 61034-2
- **Low Voltage Directive** 2014/35/EU
- **RoHS Directive** 2011/65/EU

Installation conditions

Minimum installation temperature	-15°C
Recommended min. bending radius	10 times the cable diameter
Recommended maximum tensile stress	50 N/mm ² of the cross-section of the copper

Functional characteristics

Rated voltage U ₀ /U	300/500 V
Max. operating temperature	70°C
Min. operating temperature	-30°C (without mechanical shocks)
Max. short circuit temperature	160°C

Cable Marking

Tratos EXQ TRI-LIGHT [form.] 300/500 V Dca-s2,d2,a2 [year] [prod. order]

Colours

THREE-CORE  or 
 FIVE-CORE  or 

Formation	Approx. conductor \emptyset	Approx. external \emptyset	Max. electrical resistance at 20°C	Approx. cable weight	Current rating at 30°C in pipe inside wall
n° x mm ²	mm	mm	Ω /km	kg/km	A
3 x 1,5	1,4	8,2	12,1	110	15
3 x 2,5	1,8	9,7	7,41	155	20
5 x 1,5	1,4	10,0	12,1	160	14
5 x 2,5	1,8	11,5	7,41	225	19

XMCMK cable

TRATOS XMCMK

Suitable for the transport of power in free air, for use outdoor and indoor. Installation in brickwork, metal structures, gangways, pipes, ducts or similar closed systems. Suitable for photovoltaic electrical system in the connection between the inverter and the power grid. Allowed for underground laying.

N.B. For applications not covered by Regulation EU 305/2011.

FEATURES AND PERFORMANCES

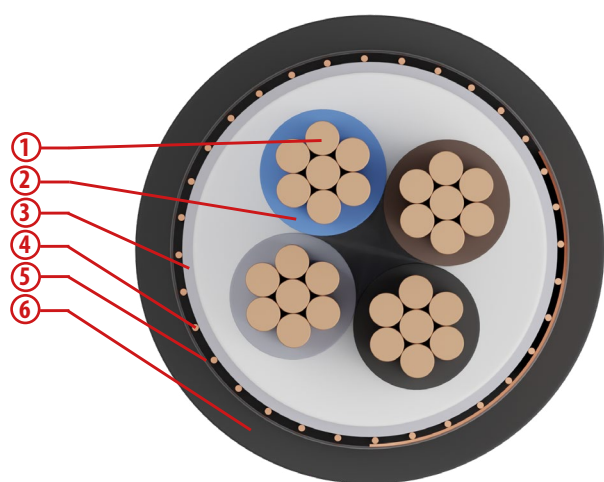

CONSTRUCTION

1. CLASS 1, SOLID, PLAIN COPPER (CROSS-SECTION = 6 MM²)
CLASS 2, STRANDED WIRE, PLAIN COPPER (CROSS-SECTION ≥ 10 MM²)
2. XLPE
3. PROTECTION THERMOPLASTIC FILLING COMPOUND
4. PLAIN COPPER WIRES WITH COPPER TAPE
5. POLYESTER FOIL
6. PVC, TYPE RZ

Structure and electrical, physical, mechanical requirements: HD 603 IEC 60502-1 ref. to CEI 20-13

- **Flame propagation** EN 60332-1-2
- **Low Voltage Directive** 2014/35/EU
- **RoHS Directive** 2011/65/EU

Installation conditions

Minimum installation temperature	0°C
Recommended min. bending radius	14 times the cable diameter
Recommended maximum tensile stress	50 N/mm ² of the cross-section of the copper

Functional characteristics

Rated voltage U ₀ /U	0,6/1 kV
Max. phase conductor operating temperature	90°C
Max. concentric conductor operating temperature	85°C
Min. handling temperature	-15°C (without mechanical shocks)
Max. phase conductor short circuit temperature	250°C
Max. concentric conductor short circuit temperature	160°C

Cable Marking

Tratos XMCMK [form.] [year] [traceability] [metric]

Colours

FOUR-CORE or

Formation n° x mm ²	Approx. conductor ∅ mm	Average insulation thickness mm	Average sheath thickness mm	Max. external ∅ mm	Max. electrical resistance at 20°C Ω/km	Approx. cable weight kg/km	Current rating A			
							in air at 30°C	in pipe in air at 30°C	buried at 20°C	
									K = 1	K = 1,5
4x6+6C	2,7	0,7	1,5	16,5	3,08	675	54	44	60	52
4x10+10C	4,0	0,7	1,6	19,3	1,83	930	75	60	79	70
4x16+16C	4,8	0,7	1,7	21,5	1,15	1525	100	80	103	91
4x25+16C	6,0	0,9	1,8	25,5	0,727	1650	127	105	133	117
4x35+16C	7,0	0,9	1,9	28,4	0,524	2120	158	128	159	140

N.B. K=1: resistivity of the ground equal to 1,0 K-m/W
 K=1,5: resistivity of the ground equal to 1,5 K-m/W

TRATOS General Cables®

S1XZ1-U/R-0,6/1 kV cable

TRATOS S1XZ1-U/R-0,6/1 kV

Particularly recommended for energy transmission in fire risk areas with the presence of large number of people, including schools offices, theatres, underground stations, hospitals and department stores. For fixed applications inside dry or humid environments, or outdoors on buildings and metallic structures. Can be laid underground.

Reference Construction Products Regulation 305/2011 EU and Standard EN 50575:

Given its properties of limiting the development of fire, heat emission and noxious fumes, the cable is suitable for the supply of electricity in buildings and other civil engineering works.

FEATURES AND PERFORMANCES

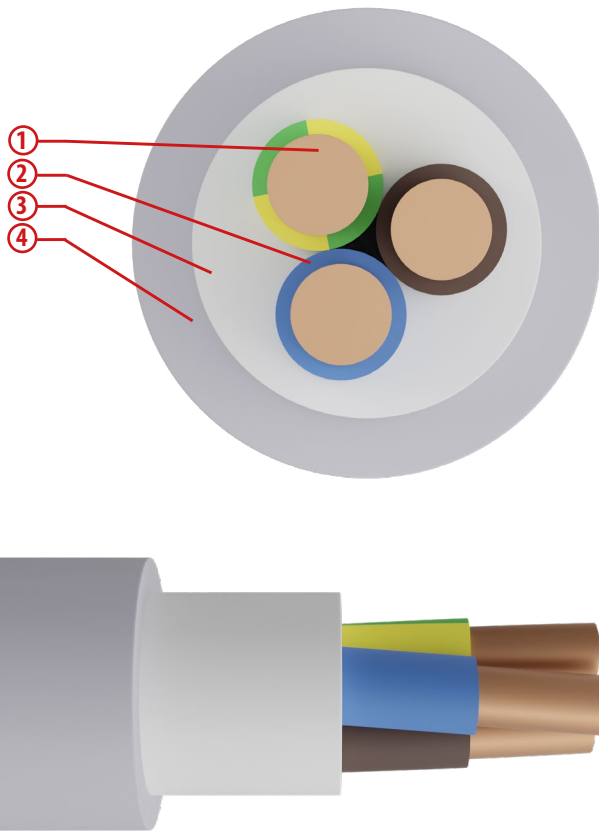

CONSTRUCTION

1. CLASS 1, SOLID, PLAIN COPPER ((CROSS-SECTION $\leq 2,5$)
CLASS 2, STRANDED WIRE, PLAIN COPPER (CROSS-SECTION ≥ 4)
2. CROSS-LINKED POLYETHYLENE (XLPE)
3. PAPER TAPE
4. LSOH THERMOPLASTIC, QUALITY M1 (UV RESISTANT)
5. LSOH THERMOPLASTIC FILLING COMPOUND (ONLY MULTI-CORE CABLES)

LSOH = Low Smoke Zero Halogen

Structure and electrical, physical, mechanical requirements: SEV TP 20B/3C IEC 60502-1

- Corrosive gases or halogens EN 50267-2-1
EN 50267-2-2
- Low Voltage Directive 2014/35/EU
- RoHS Directive 2011/65/EU

Installation conditions

Minimum installation temperature	-5°C
Recommended min. bending radius	6 times the cable diameter
Recommended maximum tensile stress	50 N/mm ² of the cross-section of the copper

Functional characteristics

Rated voltage U ₀ /U	0,6/1 kV
Max. operating temperature	90°C
Min. operating temperature	-15°C (without mechanical shocks)
Max. short circuit temperature	250°C

Cable Marking

Tratos S1XZ1-U/R [form.] [year] [traceability]

Colours

- TWO-CORE
- THREE-CORE or
- FOUR-CORE or
- FIVE-CORE or

The cores in multiple cables for signal and control are black, numbered, with or without GREEN/YELLOW

S1XZ1-U/R

Formation	Approx. conductor \emptyset	Approx. external \emptyset	Max. electrical resistance at 20°C	Approx. cable weight	Current rating at 30°C in pipe inside wall
n° x mm ²	mm	mm	Ω /km	kg/km	A
2 x 1,5 (* Eca)	1,4	8,4	12,1	110	26
3 x 1,5	1,4	8,8	12,1	125	23
3 x 2,5	1,8	9,8	7,41	170	32
3 x 4	2,2	11,4	4,61	245	42
3 x 6	3,0	12,7	3,08	325	54
4 x 6	3,0	13,8	3,08	395	54
4 x 10	3,8	16,2	1,83	590	75
4 x 16 (* Eca)	4,7	17,8	1,15	830	100
5 x 1,5	1,4	10,0	12,1	170	23
5 x 2,5	1,8	11,3	7,41	235	32
5 x 4	2,2	13,3	4,61	345	42
5 x 6	3,0	14,9	3,08	465	54
5 x 10	3,8	17,6	1,83	710	75
5 x 16	4,7	19,5	1,15	1020	100
7 x 1,5	1,4	10,4	12,1	200	13
7 x 2,5	1,8	11,9	7,41	290	17,5

(*) The formation is certified with the fire reaction class Eca

N.B. Permissible current rating values are according to:

- three conductor charged for single-core, three-core, four-core and five-core cables
- More than five conductors, all conductors are charged (except for the green/yellow).

ELQYB cable

TRATOS ELQYB

For telecommunication, safety and alarm systems in fire risk environments. Good resistance to atmospheric agents.

Reference Construction Products Regulation 305/2011 EU and Standard EN 50575:

Given its properties of limiting the development of fire and heat emission, the cable is suitable for the supply of electricity in buildings and other civil engineering works.

FEATURES AND PERFORMANCES

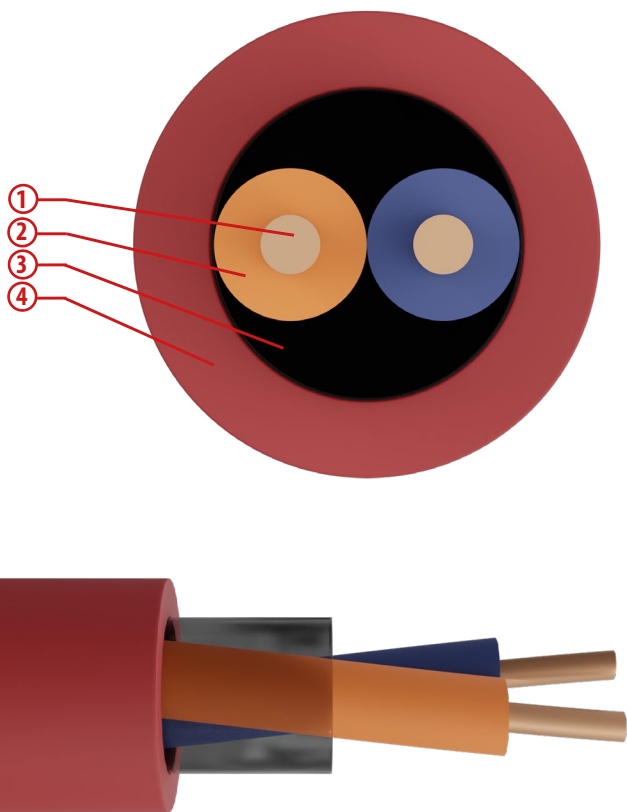

CONSTRUCTION

1. CLASS 1, SOLID, PLAIN COPPER
2. POLYETHYLENE
3. POLYESTER FOIL
4. LS0H THERMOPLASTIC POLYOLEFIN

LS0H = Low Smoke Zero Halogen

Structure and electrical, physical, mechanical requirements: ref to. SS 424 16 16

- Corrosive gases or halogens EN 50267-2-1
EN 20267-2-2
- Smoke density (transmittance) EN 61034-2
- Low Voltage Directive 2014/35/EU
- RoHS Directive 2011/65/EU

Cable Marking

Tratos ELQYB [form.] LSZH EN 60332-1-2 [year]

Installation conditions

Minimum installation temperature	-5°C
Recommended min. bending radius	10 times the cable diameter
Recommended maximum tensile stress	50 N/mm ² of the cross-section of the copper

Functional characteristics

Rated voltage	100 V
Max. operating temperature	70°C
Min. operating temperature	-20°C (without mechanical shocks)
Insulation resistance at 20°C	min. 5000 MΩ·km
Mutual capacity (800 Hz)	max. 55 nF/km
Capacity unbalance (800 Hz)	max. 150 pF/500 m

Formation	Approx. conductor Ø	Average insulation thickness	Average sheath thickness	Max. external Ø	Approx. cable weight	Max. electrical resistance at 20°C
n° x mm ²	mm	mm	mm	mm	Ω/km	Ω/km
2 x 1	1,0	0,5	0,8	6,3	37	24,5

CABLES FOR A MOVING WORLD

TRATOS[®] ENERGY DNOs

Tratos Utility cables are designed and tested to meet relevant UK, European and International standards. Manufactured in state of the art manufacturing facilities, the company's purpose-built, in-house Fire, Chemical, Electrical and Physical testing facilities and laboratories deliver peace of mind to customers ensuring their choice of Utility cable products meet all statutory and regulatory requirements.



www.tratosgroup.com



YDY cable

TRATOS YDY

These cables are used for laying in industrial and home installation, on and under the plaster, in dry, damp and wet rooms and in pipes and in concrete, with the exception of direct fixing on single-fractional poured, vibrated and compacted concrete. They may also be used outside if they are protected against direct influence of sun.

N.B. For applications not covered by Regulation EU 305/2011.

FEATURES AND PERFORMANCES

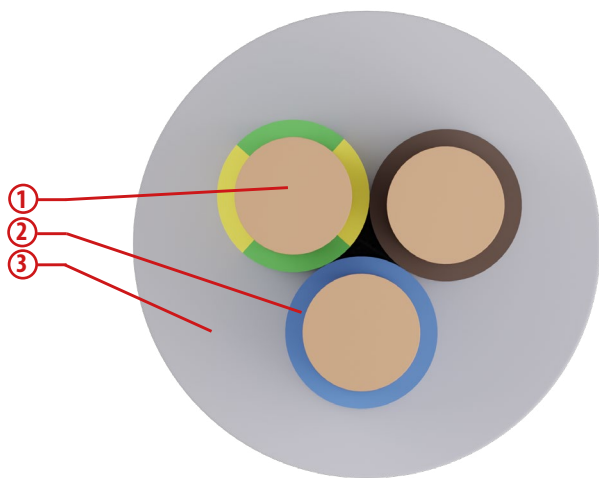

CONSTRUCTION

1. CLASS 1, SOLID, PLAIN COPPER
2. PVC, TYPE T11
3. PVC, TYPE TM1

YDYzo: with green/yellow core
YDY: without green/yellow core

Structure and electrical, physical, mechanical requirements: EN 50525-1

- **Flame propagation** EN 60332-1-2
- **Low Voltage Directive** 2014/35/EU
- **RoHS Directive** 2011/65/EU

Installation conditions

Minimum installation temperature	-5°C
Recommended min. bending radius	6 times the cable diameter
Recommended maximum tensile stress	50 N/mm ² of the cross-section of the copper

Functional characteristics

Rated voltage U ₀ /U	450/750 V
Max. operating temperature	70°C
Min. operating temperature	-30°C (without mechanical shocks)
Max. short circuit temperature	160°C

Cable Marking

Tratos YDYzo 450/750V [form.] mm² [year] (CE logo) [metric]

Colours

THREE-CORE  or 
 FOUR-CORE  or 
 FIVE-CORE  or 

Formation	Approx. conductor \emptyset	Average insulation thickness	Average sheath thickness	Approx. external \emptyset	Current rating at 30°C in pipe inside wall	Approx. cable weight
n° x mm ²	mm	mm	mm	mm	Ω /km	kg/km
3 x 1,5	1,4	0,7	1,2	8,0	12,1	115
3 x 2,5	1,8	0,8	1,2	9,3	7,41	160
3 x 4	2,5	0,8	1,2	10,3	4,61	220
3 x 6	3,1	0,8	1,3	11,6	3,08	300
3 x 10	3,9	1,0	1,3	14,3	1,83	475
4 x 1,5	1,4	0,7	1,2	8,7	12,1	140
4 x 2,5	1,8	0,8	1,2	10,1	7,41	200
4 x 4	2,5	0,8	1,3	11,4	4,61	275
4 x 6	3,1	0,8	1,3	12,7	3,08	365
4 x 10	3,9	1,0	1,3	15,7	1,83	590
5 x 1,5	1,4	0,7	1,2	9,5	12,1	160
5 x 2,5	1,8	0,8	1,2	11,0	7,41	230
5 x 4	2,5	0,8	1,3	12,4	4,61	325
5 x 6	3,1	0,8	1,3	13,9	3,08	435
5 x 10	3,9	1,0	1,3	17,2	1,83	705

YDYp cable

TRATOS YDYp

For fixed wiring in power equipment, in dry rooms on plaster and under plaster.

N.B. For applications not covered by Regulation EU 305/2011.

FEATURES AND PERFORMANCES

CONSTRUCTION

1. CLASS 1, SOLID, PLAIN COPPER
2. PVC, TYPE T11
3. PVC, TYPE TM1, FLAT SHAPE

YDYzo: with green/yellow core
YDY: without green/yellow core

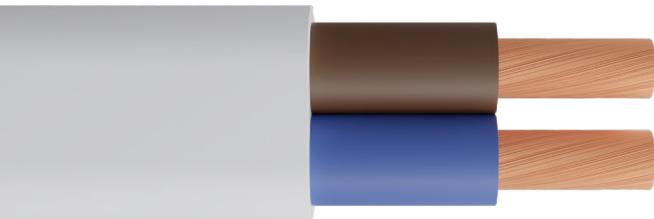
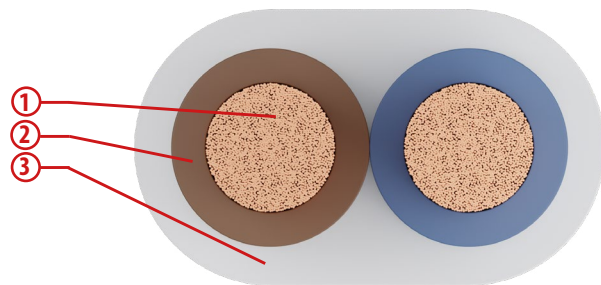

Structure and electrical, physical, mechanical requirements: EN 50525-1

- **Flame propagation** EN 60332-1-2
- **Low Voltage Directive** 2014/35/EU
- **RoHS Directive** 2011/65/EU

Installation conditions

Minimum installation temperature	-5°C
Recommended min. bending radius	6 times the cable diameter
Recommended maximum tensile stress	50 N/mm ² of the cross-section of the copper

Functional characteristics

Rated voltage U ₀ /U	450/750 V
Max. operating temperature	70°C
Min. operating temperature	-30°C (without mechanical shocks)
Max. short circuit temperature	160°C

Cable Marking

Tratos YDYpzo 450/750V [form.] mm² [year] (CE logo) [metric]

Colours

THREE-CORE or

FOUR-CORE or

FIVE-CORE

Formation	Approx. conductor \emptyset	Average insulation thickness	Average sheath thickness	Approx. external \emptyset	Current rating at 30°C in pipe inside wall	Approx. cable weight
n° x mm ²	mm	mm	mm	mm	Ω /km	kg/km
3 x 1,5	1,4	0,7	1,2	5,0 x 10,2	12,1	100
3 x 2,5	1,8	0,8	1,2	5,5 x 12,0	7,41	145
3 x 4	2,5	0,8	1,2	6,2 x 13,5	4,61	200
4 x 1,5	1,4	0,7	1,2	5,0 x 12,9	12,1	130
4 x 2,5	1,8	0,8	1,2	5,5 x 15,2	7,41	190
4 x 4	2,5	0,8	1,3	6,2 x 17,2	4,61	260
5 x 1,5	1,4	0,7	1,2	5,0 x 15,5	12,1	160
5 x 2,5	1,8	0,8	1,2	5,5 x 15,5	7,41	200
5 x 4	2,5	0,8	1,3	6,2 x 20,9	4,61	280

N2XY cable

TRATOS N2XY

For permanent installations indoors and outdoors, in cable canals and directly in the ground. They are used for supplying power to electric power devices in agglomerate and to industrial buildings.

N.B. For applications not covered by Regulation EU 305/2011.

FEATURES AND PERFORMANCES

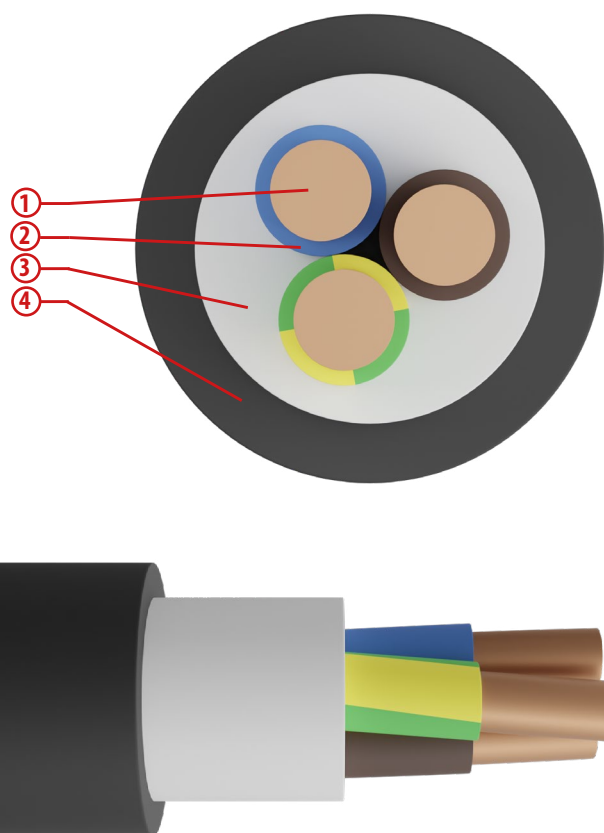

CONSTRUCTION

1. CLASS 1, SOLID, PLAIN COPPER (RE) (CROSS-SECTION \leq 10 MM²); CLASS 2, STRANDED WIRE, PLAIN COPPER (RM) (CROSS-SECTION \geq 16 MM²)
2. XLPE (CROSS-LINKED POLYETHYLENE)
3. THERMOPLASTIC FILLING COMPOUND (ONLY MULTI-CORE CABLES)
4. PVC, TYPE DMV6 (UV RESISTANT)

Structure and electrical, physical, mechanical requirements: IEC 60502-1 DIN VDE 0276-603 (1 ÷ 5 cores)
DIN VDE 0276-627 (7 ÷ 61 cores)

- **Flame propagation** EN 60332-1-2
IEC 60332-1-2
- **Low Voltage Directive** 2014/35/EU
- **RoHS Directive** 2011/65/EU

Installation conditions

Minimum installation temperature	5°C
Recommended min. bending radius	6 times the cable diameter
Recommended maximum tensile stress	50 N/mm ² of the cross-section of the copper

Functional characteristics

Rated voltage U ₀ /U	0,6/1 kV
Max. operating temperature	90°C
Min. operating temperature	-30°C (without mechanical shocks)
Max. short circuit temperature	250°C

Cable Marking

Tratos VDE 0276 N2XY-J/O [form.] RM 0,6/1 kV [year] [metric]
Tratos VDE 0276 N2XY-J/O [form.] RE 0,6/1 kV [year] [metric]

Colours

- SINGLE-CORE ● Blue or green/yellow on request (not according to VDE standards)
- TWO-CORE ● ●
- THREE-CORE ● ● ● or ● ● ●
- FOUR-CORE ● ● ● ● or ● ● ● ●
- FIVE-CORE ● ● ● ● ● or ● ● ● ● ●

Formation n° x mm ²	Approx. conductor Ø mm	Average insulation thickness mm	Nominal sheath thickness mm	Approx. external Ø mm	Max. electrical resistance at 20°C Ω/km	Approx. cable weight kg/km	Current rating A	
							free air 30°C	buried 20°C
1 x 70	9,7	1,1	1,8	15,6	0,268	750	263	256
1 x 95	11,4	1,1	1,8	17,3	0,193	995	325	307
1 x 120	13,1	1,2	1,8	18,9	0,153	1245	380	349
1 x 150	14,6	1,4	1,8	20,7	0,124	1495	437	393
1 x 240	18,5	1,7	1,8	25,7	0,0754	2410	604	517
1 x 300	21,0	1,8	1,8	27,9	0,0601	3010	697	583
1 x 630	30,3	2,4	2,2	39,7	0,0283	6330	1083	663
3 x 2,5	1,8	0,7	1,8	11,2	7,41	200	32	40
3 x 4	2,3	0,7	1,8	12,1	4,61	260	42	52
3 x 6	2,8	0,7	1,8	13,2	3,08	335	53	64
3 x 10	3,5	0,7	1,8	15,1	1,83	485	74	86
3 x 16	4,8	0,7	1,8	17,5	1,15	700	98	112
4 x 2,5	1,8	0,7	1,8	11,9	7,41	235	32	40
4 x 4	2,3	0,7	1,8	13,0	4,61	305	42	52
4 x 6	2,8	0,7	1,8	14,3	3,08	405	53	64
4 x 10	3,5	0,7	1,8	16,3	1,83	595	74	86
4 x 16	4,8	0,7	1,8	19,1	1,15	865	98	112
5 x 2,5	1,8	0,7	1,8	12,8	7,41	270	32	40
5 x 4	2,3	0,7	1,8	14,0	4,61	360	42	52
5 x 6	2,8	0,7	1,8	15,4	3,08	475	53	64
5 x 10	3,5	0,7	1,8	17,7	1,83	705	74	86
5 x 16	4,8	0,7	1,8	20,7	1,15	1055	98	112
5 x 25	6,0	0,9	1,8	24,9	0,727	1580	133	145
5 x 35	7,0	0,9	1,8	27,5	0,524	2095	162	174
5 x 50	8,1	1,0	2,0	31,5	0,387	2825	197	206
5 x 95	11,4	1,1	2,3	41,6	0,193	5375	308	305
5 x 120	13,1	1,2	2,4	47,2	0,153	6790	359	348
5 x 150	14,6	1,4	2,6	51,5	0,124	8390	412	392

Permissible current rating values are according to:

- three-phase circuit for single-core, three-core, four-core, five-core and multi-core cables

MTO cable

TRATOS MTO

MTO cables are designed for power supply connections to all types of mobile equipment and vehicles used in quarrying, open-cast mining and other large scale civil engineering operations. For applications in mining and milling sites, construction plants, industry etc.

N.B. For applications not covered by Regulation EU 305/2011.

FEATURES AND PERFORMANCES

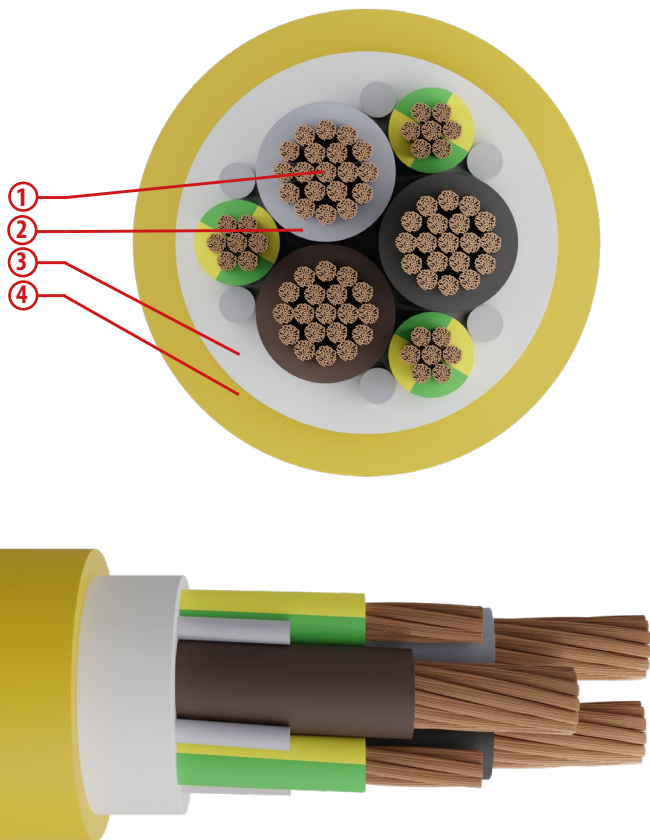

CONSTRUCTION

1. CLASS 5, FLEXIBLE, PLAIN COPPER WIRE
2. EPR CROSS-LINKED
3. PAPER TAPE
4. POLYURETHANE TMPU (ANTI-TORSION)

Structure and electrical, physical, mechanical requirements: IEC 60228 CENELEC HD 308 S2

• Flame propagation	EN 60332-1-2
• Corrosive gases or halogens	EN 50267-2-1
• Low Voltage Directive	2014/35/EU
• RoHS Directive	2011/65/EU

Installation conditions

Minimum installation temperature	-30°C
Recommended min. bending radius	10 times the cable diameter
Recommended maximum tensile stress	15 N/mm ² of the cross-section of the copper for mobile use, 50 N/mm ² for static use.

Special features

- Zero Halogen
- No flame propagation
- Good flexibility and mechanical resistance to abrasion
- Good resistance to atmospheric agents, grease and mineral oils
- Good flexibility and behavior at low temperature

Cable Marking

Tratos MTO [form.] [traceability] [year] Made in Italy [metric]

Functional characteristics

Rated voltage U ₀ /U	0,6/1 kV
Test voltage	4 kV
Max. operating temperature	90°C
Min. operating temperature	-60°C (without mechanical shocks)
Max. short circuit temperature	250°C
Max. unwinding speed	80 m/min

MTO - 0,6/1 kV

Formation	Approx. conductor Ø	Average insulation thickness	Average sheath thickness	Minimum sheath thickness at any point	Approx. external Ø	Max. electrical resistance at 20°C	Approx. cable weight
n° x mm ²	mm	mm	mm	mm	mm	Ω/km	kg/km
3x25+3G6	3,1/3,0	1,5/1,0	2,3	2,0	23,8	0,78/3,30	1270
3x35+3G6	7,3/3,0	1,6/1,0	2,3	2,0	26,8	0,554/3,30	1615
3x50+3G10	8,7/3,9	1,8/1,1	3,3	3,0	32,6	0,386/1,91	2375
3x70+3G16	10,5/5,0	1,9/1,2	3,3	3,0	36,8	0,272/1,21	3255
3x95+3G16	11,9/5,0	2,0/1,2	3,3	3,0	40,2	0,206/1,21	3945
3x120+3G25	13,9/6,1	2,2/1,5	4,5	4,0	47,5	0,161/0,78	5385
3x150+3G25	15,4/6,1	2,3/1,5	5,5	5,0	53,2	0,129/0,78	6445
3x25+3G6+2x1,5	6,1/3,0/1,5	1,5/1,0/1,0	2,3	2,0	23,8	0,78/3,30/13,3	1310
3x25+3G6+2x2,5	6,1/3,0/1,9	1,5/1,0/1,0	2,3	2,0	23,8	0,780/3,30/7,98	1370
3x35+3G6+2x1,5	7,3/3,0/1,5	1,6/1,0/1,0	2,3	2,0	23,8	0,554/3,30/13,3	1645
3x35+3G6+2x2,5	7,3/3,0/1,9	1,6/1,0/1,0	2,3	2,0	23,8	0,554/3,30/7,98	1715
3x50+3G10+2x1,5	8,7/3,9/1,5	1,8/1,1/1,0	3,3	3,0	32,6	0,386/1,91/13,3	2385
3x50+3G10+2x2,5	8,7/3,9/1,9	1,8/1,1/1,0	3,3	3,0	32,6	0,386/1,91/7,98	2490
3x70+3G16+2x1,5	10,5/5,0/1,5	1,9/1,2/1,0	3,3	3,0	36,8	0,272/1,21/13,3	3255
3x70+3G16+2x2,5	10,5/5,0/1,9	1,9/1,2/1,0	3,3	3,0	36,8	0,272/1,21/7,98	3345
3x95+3G16+2x1,5	11,9/5,0/1,5	2,0/1,2/1,0	3,3	3,0	40,2	0,206/1,21/13,3	3930
3x95+3G16+2x2,5	11,9/5,0/1,9	2,0/1,2/1,0	3,3	3,0	40,2	0,206/1,21/7,98	4025
3x120+3G25+2x1,5	13,9/6,1/1,5	2,2/1,5/1,0	4,5	4,0	47,5	0,161/0,78/13,3	5300
3x120+3G25+3x2,5	13,85/6,1/1,9	2,2/1,5/1,0	4,5	4,0	47,5	0,161/0,554/7,98	5405
3x150+3G25+2x1,5	15,4/6,1/1,5	2,3/1,5/1,0	5,5	5,0	53,2	0,129/0,78/13,3	6430
3x150+3G25+2x2,5	15,4/6,1/1,9	2,3/1,5/1,0	5,5	5,0	53,2	0,129/0,78/7,98	6550
3x185+3G35+2x1,5	16,9/7,3/1,5	2,4/1,6/1,0	5,9	5,4	57,6	0,106/0,554/13,3	7955
3x185+3G35+2x2,5	16,9/7,3/1,9	2,4/1,6/1,0	5,9	5,4	57,6	0,106/0,554/7,98	8080
3x240+3G50+2x1,5	19,4/8,7/1,5	2,4/1,8/1,0	5,9	5,4	62,8	0,0801/0,386/13,3	10005
3x240+3G50+2x2,5	19,4/8,7/1,9	2,4/1,8/1,0	5,9	5,4	62,8	0,0801/0,386/7,98	10140
4G10	3,9	1,1	2,3	2,0	19,2	1,91	680
4G16	5,0	1,2	2,3	2,0	22,1	1,21	960
4G25	6,1	1,5	2,8	2,5	26,5	0,78	1540
4G35	7,3	1,6	2,9	2,6	29,8	0,554	2050
4G50	8,7	1,8	2,9	2,6	34,3	0,386	2820
4G70	10,5	1,9	3,0	2,7	38,9	0,272	3805
4G95	11,9	2,0	3,3	3,0	44,0	0,206	4925
4G120	13,85	2,2	3,4	3,1	47,9	0,161	6105
4G150	15,4	2,3	3,6	3,3	53,3	0,129	7535
5G2,5	1,9	1,0	1,3	1,1	12,4	7,98	235

Nominal cross-section	mm ²	1,5	2,5	4	6	10	16	25	35	50	70	95	120	150	185	240
Current rating at 30 °C A	Multi-cores cable in free air	23	32	42	54	75	100	127	158	192	246	298	346	399	456	538
	Multi-cores cable buried	22	30	40	51	71	95	121	150	182	234	283	329	375	428	511

XPJ cable

TRATOS XPJ

Suitable for energy supply in industry, workshops, residential building, and in agricultural applications. For fixed installations inside and outside. It must not be laid underground.

Reference Construction Products Regulation 305/2011 EU and Standard EN 50575:

The cable is suitable for the supply of electricity in buildings and other civil engineering works.

FEATURES AND PERFORMANCES

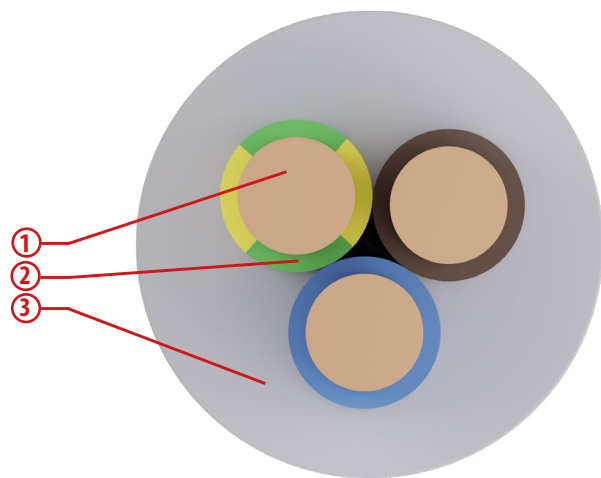

CONSTRUCTION

1. CLASS 1, SOLID, PLAIN COPPER (CROSS-SECTION $1,5 \div 4$)
CLASS 2, STRANDED WIRE, PLAIN COPPER (CROSS-SECTION $6 \div 25$)
2. CROSS-LINKED POLYETHYLENE (XLPE)
3. PVC (THE OUTER SHEATH FILLS THE INTERSTICES BETWEEN CORES, THUS COMPRISING THE INNER SHEATH)

Structure and electrical, physical, mechanical requirements: ref. to EVS 720:2015

- Low Voltage Directive 2014/35/EU
- RoHS Directive 2011/65/EU

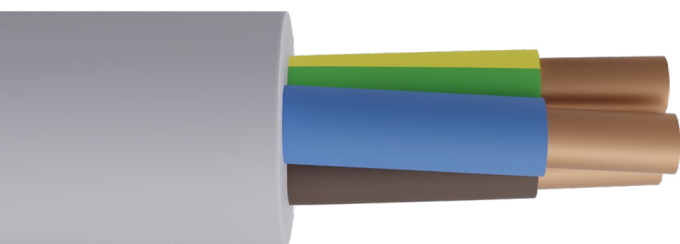

Installation conditions

Minimum installation temperature	-15°C
Recommended min. bending radius	6 times the cable diameter
Recommended maximum tensile stress	50 N/mm ² of the cross-section of the copper

Functional characteristics

Rated voltage U _o /U	300/500 V - 450/750 V
Max. operating temperature	70°C
Min. operating temperature	-30°C (without mechanical shocks)
Max. short circuit temperature	160°C

Cable Marking

Tratos XPJ [form.] 300/500V EVS 720:2015 [year] [traceability] [metric]

Tratos XPJ [form.] 450/750V EVS 720:2015 [year] [traceability] [metric]

Colours

THREE-CORE   or  

FOUR-CORE   or  

SYMMETRIC VERSION   or  

U_o/U: 300/500V

Formation	Approx. conductor \emptyset	Average insulation thickness	Average sheath thickness	Approx. external \emptyset	Approx. cable weight	Max. electrical resistance at 20°C
n° x mm ²	mm	mm	mm	mm	kg/km	Ω /km
3 x 1,5	1,4	0,5	1,2	7,6	95	12,1
3 x 2,5	1,8	0,5	1,2	8,3	130	7,41
4 x 1,5	1,4	0,5	1,2	8,2	115	12,1
5 x 1,5	1,4	0,5	1,2	8,8	135	12,1
5 x 2,5	1,8	0,5	1,2	9,8	185	7,41

U_o/U: 450/750V

Formation	Approx. conductor \emptyset	Average insulation thickness	Average sheath thickness	Approx. external \emptyset	Approx. cable weight	Max. electrical resistance at 20°C
n° x mm ²	mm	mm	mm	mm	kg/km	Ω /km
5 x 4	2,5	0,6	1,5	12,0	290	4,61
5 x 6	3,1	0,6	1,5	14,2	420	3,08
5 x 10	3,9	0,7	1,7	17,3	665	1,83
5 x 16	5,0	0,7	1,7	19,7	955	1,15

Plain copper stranded wire cable

TRATOS Plain copper stranded wire

For ground systems.

FEATURES AND PERFORMANCES

CONSTRUCTION

1. PLAIN COPPER WIRE, STRANDED COMPACTED, CLASS 2

Product obtained by working of annealed copper wire obtained from wire rod copper type Cu-ETP1 UNI EN 1977.

Structure: CEI EN 60228 (class 2) IEC 60228

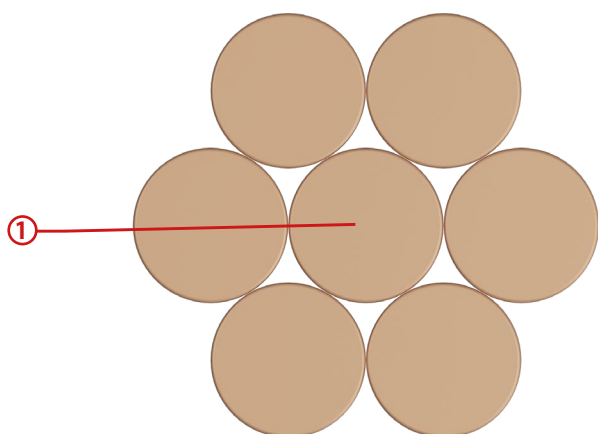

Formation	Number of wire	Approx. conductor \emptyset	Max. electrical resistance at 20°C	Approx. cable weight
mm ²	mm	mm	mm	mm
10	7	3,85	1,83	85
16	7	4,70	1,15	135
25	7	5,95	0,727	213
35	7	7,00	0,524	296
50	10	7,90	0,387	406
70	14	9,70	0,268	580
95	19	11,50	0,193	810
120	24	12,90	0,153	1025
150	30	14,20	0,124	1250
185	38	16,00	0,0991	1590
240	48	18,50	0,0754	2060

CABLES FOR A MOVING WORLD

TRATOS[®] ENERGY DNOs

Tratos Utility cables are designed and tested to meet relevant UK, European and International standards. Manufactured in state of the art manufacturing facilities, the company's purpose-built, in-house Fire, Chemical, Electrical and Physical testing facilities and laboratories deliver peace of mind to customers ensuring their choice of Utility cable products meet all statutory and regulatory requirements.



www.tratosgroup.com



www.tratosgroup.com



<https://tratosgroup.com/contact-tratos/>